

Semiconductors

Book S8b

1986

Optoelectronic devices

Elcoma – Philips Electronic Components and Materials Division – embraces a world-wide group of companies operating under the following names:

IBRAPE



Miniwatt

Signetics

Mullard

VALVO

PHILIPS

Elcoma offers you a technological partnership in developing your systems to the full. A partnership to which we can bring

- world-wide production and marketing
- know-how
- systems approach
- continuity
- broad product line
- fundamental research
- leading technologies
- applications support
- quality

OPTOELECTRONIC DEVICES

	<i>page</i>
Selection guide	1
Type number survey (alpha-numerical)	21
General	
Safety recommendations	25
Rating systems	27
Letter symbols	29
Pro electron types/designations	35
Definitions of optocouplers	37
Current transfer ratio of an optocoupler	47
Optocoupler switching times	48
Optocoupler survey list of approvals/recognitions	49
Device data	
A1. Optocouplers in a plastic encapsulation	51
B1. Special optocouplers (opto high-tech line)	297
B2. Photosensitive semiconductors	339
B3. Infrared light emitting diodes	403
C1. Laser and fibre-optic components	449
C2. Infrared sensors	491
Index of all devices in semiconductor Data Handbooks	595

DATA HANDBOOK SYSTEM

Our Data Handbook System comprises more than 60 books with specifications on electronic components, subassemblies and materials. It is made up of four series of handbooks:

ELECTRON TUBES	BLUE
SEMICONDUCTORS	RED
INTEGRATED CIRCUITS	PURPLE
COMPONENTS AND MATERIALS	GREEN

The contents of each series are listed on pages iv to viii.

The data handbooks contain all pertinent data available at the time of publication, and each is revised and reissued periodically.

When ratings or specifications differ from those published in the preceding edition they are indicated with arrows in the page margin. Where application information is given it is advisory and does not form part of the product specification.

Condensed data on the preferred products of Philips Electronic Components and Materials Division is given in our Preferred Type Range catalogue (issued annually).

Information on current Data Handbooks and on how to obtain a subscription for future issues is available from any of the Organizations listed on the back cover.

Product specialists are at your service and enquiries will be answered promptly.

ELECTRON TUBES (BLUE SERIES)

The blue series of data handbooks comprises:

- T1** **Tubes for r.f. heating**
- T2a** **Transmitting tubes for communications, glass types**
- T2b** **Transmitting tubes for communications, ceramic types**
- T3** **Klystrons**
- T4** **Magnetrons for microwave heating**
- T5** **Cathode-ray tubes**
Instrument tubes, monitor and display tubes, C.R. tubes for special applications
- T6** **Geiger-Müller tubes**
- T8** **Colour display systems**
Colour TV picture tubes, colour data graphic display tube assemblies, deflection units
- T9** **Photo and electron multipliers**
- T10** **Plumbicon camera tubes and accessories**
- T11** **Microwave semiconductors and components**
- T12** **Vidicon and Newvicon camera tubes**
- T13** **Image intensifiers and infrared detectors**
- T15** **Dry reed switches**
- T16** **Monochrome tubes and deflection units**
Black and white TV picture tubes, monochrome data graphic display tubes, deflection units

SEMICONDUCTORS (RED SERIES)

The red series of data handbooks comprises:

- S1 Diodes**
Small-signal silicon diodes, voltage regulator diodes (< 1,5 W), voltage reference diodes, tuner diodes, rectifier diodes
- S2a Power diodes**
- S2b Thyristors and triacs**
- S3 Small-signal transistors**
- S4a Low-frequency power transistors and hybrid modules**
- S4b High-voltage and switching power transistors**
- S5 Field-effect transistors**
- S6 R.F. power transistors and modules**
- S7 Surface mounted semiconductors**
- S8a Light-emitting diodes**
- S8b Devices for optoelectronics**
Optocouplers, photosensitive diodes and transistors, infrared light-emitting diodes and infrared sensitive devices, laser and fibre-optic components
- S9 Power MOS transistors**
- S10 Wideband transistors and wideband hybrid IC modules**
- S11 Microwave transistors**
- S12 Surface acoustic wave devices**
- S13 Semiconductor sensors**
- *S14 Liquid Crystal Displays**

*To be issued shortly.

INTEGRATED CIRCUITS (PURPLE SERIES)

The NEW SERIES of handbooks is now completed. With effect from the publication date of this handbook the "N" in the handbook code number will be deleted. Handbooks to be replaced during 1986 are shown below.

The purple series of handbooks comprises:

IC01	Radio, audio and associated systems Bipolar, MOS	new issue 1986 IC01N 1985
IC02a/b	Video and associated systems Bipolar, MOS	new issue 1986 IC02Na/b 1985
IC03	Integrated circuits for telephony Bipolar, MOS	new issue 1986 IC03N 1985
IC04	HE4000B logic family CMOS	new issue 1986 IC4 1983
IC05N	HE4000B logic family — uncased ICs CMOS	published 1984
IC06N	High-speed CMOS; PC74HC/HCT/HCU Logic family	published 1986
IC08	ECL 10K and 100K logic families	New issue 1986 IC08N 1984
IC09N	TTL logic series	published 1986
IC10	Memories MOS, TTL, ECL	new issue 1986 IC7 1982
IC11N	Linear LSI	published 1985
Supplement to IC11N	Linear LSI	published 1986
IC12	I²C-bus compatible ICs	not yet issued
IC13	Semi-custom Programmable Logic Devices (PLD)	new issue 1986 IC13N 1985
IC14N	Microprocessors, microcontrollers and peripherals Bipolar, MOS	published 1985
IC15	FAST TTL logic series	new issue 1986 IC15N 1985
IC16	CMOS integrated circuits for clocks and watches	first issue 1986
IC17	Integrated Services Digital Networks (ISDN)	not yet issued
IC18	Microprocessors and peripherals	new issue 1986*

* The Microprocessors were included in handbook IC14N 1985, so IC18 will replace that part of IC14N.

COMPONENTS AND MATERIALS (GREEN SERIES)

The green series of data handbooks comprises:

- C2** Television tuners, coaxial aerial input assemblies, surface acoustic wave filters
- C3** Loudspeakers
- C4** Ferroxcube potcores, square cores and cross cores
- C5** Ferroxcube for power, audio/video and accelerators
- C6** Synchronous motors and gearboxes
- C7** Variable capacitors
- C8** Variable mains transformers
- C9** Piezoelectric quartz devices
- C11** Varistors, thermistors and sensors
- C12** Potentiometers, encoders and switches
- C13** Fixed resistors
- C14** Electrolytic and solid capacitors
- C15** Ceramic capacitors
- C16** Permanent magnet materials
- C17** Stepping motors and associated electronics
- C18** Direct current motors
- C19** Piezoelectric ceramics
- C20** Wire-wound components for TVs and monitors
- C22** Film capacitors

SELECTION GUIDE

OPTOCOUPPLERS

Standard types, UL recognized and VDE approved

Transistor output

type	case	C.T.R.		VCEsat	VIORM	ton/toff (typ.)		V(BR)CEO	page	
		min.	max.			ton (µs)	toff (µs)			
		IF = 10 mA VCE = 0,4 V		IF = 10 mA IC = 2 mA	kV (a.c.) peak value	IC = 2 mA; VCC = 5 V; RL = 100 Ω				
				max. (V)				min. (V)		
CNX35U	SOT-90B	0,4	0,9	0,4		4,4	3	3	30	99
CNX39U	SOT-90B	0,6	1,0	0,4		4,4	5,5	4	30	99
CNX36U	SOT-90B	0,8	2,0	0,4		4,4	8	6	30	99
CNX57U	SOT-90B	0,2	0,8	0,4		4,4	3	3	30	233
CNY57AU	SOT-90B	0,4		0,4	4,4	5*	5*	30	233	

* IC = 4 mA.

High-voltage transistor output

type	case	C.T.R.		VCEsat	VIORM	ton/toff (typ.)		V(BR)CEO	page
		min.	max.			ton (µs)	toff (µs)		
		IF = 10 mA VCE = 0,4 V		IF = 16 mA IC = 2 mA	kV (a.c.) peak value	IC = 4 mA; VCC = 5 V; RL = 100 Ω			
				max. (V)				min. (V)	
CNX38U	SOT-90B	0,7	2,1	0,4		4,4	5	5	80

Darlington transistor output

type	case	C.T.R.		VCEsat	VIORM	ton/toff (typ.)		V(BR)CEO	page
		min.	max.			ton (µs)	toff (µs)		
		IF = 1 mA VCE = 1 V		IF = 5 mA IC = 10 mA	kV (a.c.) peak value	IF = 1 mA; VCC = 5 V; RL = 100 Ω; RBE = 1 MΩ			
				max. (V)				min. (V)	
CNX48U	SOT-90B	5,0		1,0		4,4	5	30	30

Standard types

Transistor output

type	case	C.T.R.		V _{CEsat}	V _{IORM}	t _{on} /t _{off} (typ.)		V _{(BR)CEO}	page
		min.	max.			t _{on} (μs)	t _{off} (μs)		
		I _F = 10 mA V _{CE} = 0,4 V		I _F = 10 mA I _C = 2 mA	kV (a.c.) peak value	I _C = 2 mA; V _{CC} = 5 V; R _L = 100 Ω		min. (V)	
CNX35	SOT-90B	0,4	0,9	max. (V)		4,4	3		3
CNX39	SOT-90B	0,6	1,0	0,4	4,4	5,5	4	30	83
CNX36	SOT-90B	0,8	2,0	0,4	4,4	8	6	30	83
CNY57	SOT-90B	0,2	0,8	0,4	4,4	3	3	30	219
CNV57A	SOT-90B	0,4		0,4	4,4	5	5	30	219

High-voltage transistor output

type	case	C.T.R.		V _{CEsat}	V _{IORM}	t _{on} /t _{off} (typ.)		V _{(BR)CEO}	page
		min.	max.			t _{on} (μs)	t _{off} (μs)		
		I _F = 10 mA V _{CE} = 0,4 V		I _F = 16 mA I _C = 2 mA	kV (a.c.) peak value	I _C = 4 mA; V _{CC} = 5 V; R _L = 100 Ω		min. (V)	
CNX38	SOT-90B	0,7	2,1	max. (V)		4,4	5		5

Darlington transistor output

type	case	C.T.R.		V _{CEsat}	V _{IORM}	t _{on} /t _{off} (typ.)		V _{(BR)CEO}	page
		min.	max.			t _{on} (μs)	t _{off} (μs)		
		I _F = 1 V V _{CE} = 1 V		I _F = 5 mA; I _C = 10 mA	kV (a.c.) peak value	I _F = 1 mA; V _{CC} = 5 V; R _L = 100 Ω; R _{BE} = 1 MΩ		min. (V)	
CNX48	SOT-90B	5,0		max. (V)		4,4	5		30

Other standard types, UL recognized or pending, VDE approved.

Transistor output

type	case	C.T.R.	V _{CEsat}	V _{IORM}	t _{on} /t _{off} (typ.)	V _{(BR)CEO}	page
		I _F = 10 mA V _{CE} = 10 V	I _F = 50 mA I _C = 2 mA	kV (a.c.) peak value	I _C = 2 mA; V _{CC} = 10 V; R _L = 100 Ω	min. (V)	
		min. max.	max. (V)				t _{on} (μs)
4N25	SOT-90B	0,2	0,5	2,820	3	30	291
4N25A	SOT-90B	0,2	0,5	2,820	3	30	291
4N26	SOT-90B	0,2	0,5	2,820	3	30	291
4N27	SOT-90B	0,1	0,5	2,820	3	30	291
4N28	SOT-90B	0,1	0,5	2,820	3	30	291

type	case	C.T.R.	V _{CEsat}	V _{IORM}	t _{on} /t _{off} (typ.)	V _{(BR)CEO}	page
		I _F = 10 mA V _{CE} = 10 V	I _F = 10 mA I _C = 0,5 mA	kV (a.c.) peak value	I _C = 2 mA; V _{CC} = 10 V; R _L = 100 Ω	min. (V)	
		min. max.	max. (V)				t _{on} (μs)
4N35	SOT-90B	1,0	0,3	4,4	7	30	x
4N36	SOT-90B	1,0	0,3	2,820	7	30	x
4N37	SOT-90B	1,0	0,3	2,820	7	30	x
H11A1	SOT-90B	0,5	0,4	2,820	3*	30	259
H11A2	SOT-90B	0,2	0,4	2,820	3*	30	259
H11A3	SOT-90B	0,2	0,4	2,820	3*	30	259
H11A4	SOT-90B	0,1	0,4	2,820	3*	30	259
H11A5	SOT-90B	0,3	0,4	2,820	3*	30	x

* t_r/t_f.

x : Data sheet available on request, UL recognition pending.

SELECTION GUIDE

Other standard types, UL recognized or pending, VDE approved.

Transistor output (cont.)

type	case	C.T.R.	V _{CEsat}	V _{IORM}	t _{on} /t _{off} (typ.)	V _(BR) /CEO	page
		I _F = 10 mA V _{CE} = 10 V	I _F = 60 mA I _C = 1,6 mA	kV (a.c.) peak value	I _C = 2 mA; V _{CC} = 10 V; R _L = 100 Ω		
		min. max.	max. (V)		t _{on} (μs) t _{off} (μs)	min. (V)	
MCT26	SOT-90B	0,06	0,5	4,4	3* 3*	30	271

* t_r/t_f.

type	case	C.T.R.	V _{CEsat}	V _{IORM}	t _{on} /t _{off} (typ.)	V _(BR) /CEO	page
		I _F = 10 mA V _{CE} = 10 V	I _F = 16 mA I _C = 2 mA	kV (a.c.) peak value	I _F = 20 mA; V _{CC} = 5 V; R _L = 2 kΩ; R _{BE} = 100 KΩ		
		min. max.	max. (V)		t _{on} (μs) t _{off} (μs)	min. (V)	
MCT2	SOT-90B	0,2	0,4	4,4	5 10	30	265

High-voltage transistor output

type	case	C.T.R.	V _{CEsat}	V _{IORM}	t _{on} /t _{off} (typ.)	V _(BR) /CEO	page
		I _F = 10 mA V _{CE} = 10 V	I _F = 20 mA I _C = 4 mA	kV (a.c.) peak value	I _C = 2 mA; V _{CC} = 10 V; R _L = 100 Ω		
		min. max.	max. (V)		t _{on} (μs) t _{off} (μs)	min. (V)	
4N38	SOT-90B	0,1	1,0	2,820	5 5	80	x
4N38A	SOT-90B	0,1	1,0	2,820	5 5	80	x

x : Data sheet available on request, UL recognition pending.

Other standard types, UL recognized or pending, VDE approved.
High-voltage transistor output (cont.)

type	case	C.T.R.		VCEsat	VIORM	ton/toff (typ.)		V(BR)CEO	page	
		IF = 10 mA VCE = 5 V	max.			IC = 2 mA; VCC = 10 V; RL = 100 Ω	toff (μs)			
CNY17-1	SOT-90B	0,4	0,8	IF = 10 mA IC = 2,5 mA	kV (a.c.) peak value	5	5	min. (V)	x	
CNY17-2	SOT-90B	0,63	1,25	max. (V)		5	5			70
CNY17-3	SOT-90B	1,0	2,0	0,3		5	5			70

Darlington transistor output

type	case	C.T.R.		VCEsat	VIORM	ton/toff (typ.)		V(BR)CEO	page	
		IF = 1 mA VCE = 5 V	max.			IC = 10 mA; VCC = 10 V; RL = 100 Ω	toff (μs)			
H11B1	SOT-90B	5,0	1,0	IF = 1 mA IC = 1 mA	kV (a.c.) peak value	125	100	min. (V)	x	
H11B2	SOT-90B	2,0	1,0	max. (V)		125	100			25
H11B3	SOT-90B	1,0	1,0	1,0		125	100			25

type	case	C.T.R.		VCEsat	VIORM	ton/toff (typ.)		V(BR)CEO	page
		IF = 10 mA VCE = 5 V	max.			IC = 10 mA; VCC = 10 V; RL = 100 Ω	toff (μs)		
H11B255	SOT-90B	1,0	1,0	IF = 50 mA IC = 50 mA	kV (a.c.) peak value	125	100	min. (V)	x
		min.	max. (V)	1,0		55			

x : Data sheet available on request, UL recognition pending.

Other standard types, UL recognized or pending, VDE approved.

Darlington transistor output (cont.)

type	case	C.T.R.	V _{CEsat}	V _{IORM}	t _{on} /t _{off} (typ.)	V(BR)CEO	page
		I _F = 10 mA V _{CE} = 5 V	I _F = 50 mA; I _C = 50 mA	kV (a.c.) peak value	t _{on} (μs) t _{off} (μs)	min. (V)	
		min. max.	max. (V)				
MCA230	SOT-90B	1,0	1,0	4,4	5 100	30	x
MCA231	SOT-90B	2,0	1,2*	4,4	5 100	30	x
MCA255	SOT-90B	1,0	1,0	4,4	5 100	55	x

* I_F = 10 mA

Types for mains applications, UL recognized, VDE approved

type	case	C.T.R.	V _{CEsat}	V _{IORM}	t _{on} /t _{off} (typ.)	V(BR)CEO	page
		I _F = 10 mA V _{CE} = 0,4 V	I _F = 10 mA I _C = 4 mA	kV (a.c.) peak value	t _{on} (μs) t _{off} (μs)	min. (V)	
		min. max.	max. (V)				
CNX62	SOT-174	0,4	0,4	5,3	3 3	50	171
CNX72	SOT-90B	0,4	0,4	5,3*	26 2,5**	30	183
CNX82	SOT-212	0,4	0,4	5,3	3 3	50	195
CNX83	SOT-212	0,4	0,4	5,3	3 3	50	207

* VDE approved for 4.4 kV.

** Max. values, R_{BE} = 56 kΩ.

Notes : CNX83, UL and VDE approval pending.

CNX82 and CNX83, pin distance 10,16 mm.

CNX62 and CNX82 have no base connection.

x : Data sheet available on request, UL recognition pending.

Types with input/output pin distance 15,24 mm

type	case	C.T.R.	VCEsat	VIORM	t _{on} /t _{off} (typ.)	V(BR)CEO	page
		I _F = 10 mA VCE = 0,4 V	I _F = 10 mA I _C = 2 mA	kV (a.c.) peak value	I _C = 2 mA; V _{CC} = 5 V; R _L = 100 Ω	min. (V)	
		min. max.	max. (V)				
CNX21	SOT-211	0,2	0,4*	10	3	30	75
CNY62	SOT-91B	0,25	0,4	5,3	3	50	247
CNY63	SOT-91B	0,5	0,4▲	4,4	5	30	247

* Typ. value.

** t_r/t_f (V_{CC} = 20 V).

▲ I_C = 4 mA

Types for telephony applications, recognized by French CNET

type	case	C.T.R.	VCEsat	VIORM	t _{on} /t _{off} (typ.)	V(BR)CEO	page
		I _F = 2 mA VCE = 5 V	I _F = 50 mA I _C = 10 mA	kV (a.c.) peak value	I _C = 16 mA; V _{CC} = 5 V; R _L = 1 kΩ	min. (V)	
		min. max.	max. (V)				
SL5500	SOT-90B	0,3	0,4	2,5	20	30	x

type	case	C.T.R.	VCEsat	VIORM	t _{on} /t _{off} (typ.)	V(BR)CEO	page
		I _F = 2 mA VCE = 5 V	I _F = 10 mA; I _C = 0,5 mA	kV (a.c.) peak value	I _C = 16 mA; V _{CC} = 5 V; R _L = 1 kΩ	min. (V)	
		min. max.	max. (V)				
SL5501	SOT-90B	0,15	0,4	2,5	20	30	x

x : Data sheet available on request.

Types for telephony applications, recognized by CNET (cont.)

type	case	C.T.R.	VCEsat	VIORM	t _{on} /t _{off} (typ.)	V(BR)CEO	page
		I _F = 2 mA VCE = 5 V	I _F = 20 mA I _C = 1 mA	kV (a.c.) peak value	I _C = 10 mA; VCC = 10 V; R _L = 1 kΩ	min. (V)	
	min. max.		max. (V)				
SL5502R	SOT-211	0,20	0,3	2,5	25	32	x

type	case	C.T.R.	VCEsat	VIORM	t _{on} /t _{off} (typ.)	V(BR)CEO	page
		I _F = 2 mA VCE = 5 V	I _F = 20 mA; I _C = 2 mA	kV (a.c.) peak value	I _C = 16 mA; VCC = 5 V; R _L = 1 kΩ	min. (V)	
	min. max.		max. (V)				
SL5504	SOT-90B	0,15	0,4	2,5	50	80	x
SL5511	SOT-90B	0,25	0,4	2,5	20	30	x

New generation of optocouplers with GaAlAs emitter diode

Low current types, transistor output

type	case	C.T.R.	VCEsat	VIORM	t _{on} /t _{off} (typ.)	V(BR)CEO	page
		I _F = 10 mA VCE = 0,4 V	I _F = 10 mA; I _C = 2 mA	kV (a.c.) peak value	I _C = 2 mA; VCC = 5 V; R _L = 100 Ω	min. (V)	
	min. max.		max. (V)				
CNG35	SOT-90B	0,4	0,4	4,4	3	30	53
CNG36	SOT-90B	0,8	0,4	4,4	8	30	53

* Typ. value at I_F = 2 mA.

** Typ. value at I_F = 0,5 mA.

x : Data sheet available on request.

New generation of optocouplers with GaAlAs emitter diode (cont.)
Telephony applications, approved by British Telecom (output transistor)

type	case	C.T.R.	V _{CEsat}	V _{IORM}	t _{on} /t _{off} (typ.)		V _{(BR)CEO}	page
		IF = 10 mA V _{CE} = 0,5 V	IF = 10 mA IC = 1 mA	kV (a.c.) peak value	IC = 2 mA; V _{CC} = 5 V; R _L = 100 Ω			
		min. max.	max. (V)		t _{on} (μs)	t _{off} (μs)	min. (V)	
PO40/44A	SOT-90B	0,6 0,25*	0,5	3,5	7	7	30	277

* Min. value at IF = 1 mA; V_{CE} = 0,4 V.

Note : The PO40/44A can replace each individual type PO40A, PO41A, PO42A, PO43A and PO44A.

High-speed type, diode/transistor output

type	case	C.T.R.	V _{CEsat}	V _{IORM}	t _{on} /t _{off} (typ.)		V _{(BR)CEO}	page
		IF = 10 mA V _{CC} = 4,5 V	IF = 10 mA IC = 2 mA V _{CC} = 4,5 V	kV (a.c.) peak value	IC = 2 mA; V _{CC} = 5V; R _L = 100 Ω			
		min. max.	max. (V)		t _{on} (μs)	t _{off} (μs)	min. (V)	
CNR36	SOT-97F	0,2	0,4	3,5	0,85	0,85	18	67
SL5505S	SOT-97F	0,2	0,4	3,5	0,85	0,85	22	x

x : Data sheet available on request.

Types in metal encapsulation

Transistor output

type	case	C.T.R.	V _{CEsat}	V _{IORM}	t _{on} /t _{off} (typ.)		V _{(BR)CEO}	page
		IF = 10 mA VCE = 0,4 V			IC = 2 mA; VCC = 5 V; RL = 100 Ω			
		min. max.	max. (V)	kV (a.c.) peak value	t _{on} (μs)	t _{off} (μs)	min. (V)	
CNX44	SOT-104C	0,3		1,0	5	5	50	299
CNX46	SOT-104C	0,3		1,0	5	5	50	299
CNY50-1	SOT-104B	0,25		1,0	5	5	50	327
CNY50-2	SOT-104B	0,4		1,0	5	5	50	327

Transistor output, GaAlAs emitter diode

type	case	C.T.R.	V _{CEsat}	V _{IORM}	t _{on} /t _{off} (typ.)		V _{(BR)CEO}	page
		IF = 10 mA VCE = 0,4 V	IF = 50 mA IC = 2 mA		IC = 2 mA; VCC = 5 V; RL = 100 Ω			
		min. max.	max. (V)	kV (a.c.) peak value	t _{on} (μs)	t _{off} (μs)	min. (V)	
CNX44A	SOT-104C	0,4		1,0	5	5	60	309
CNX91	SOT-18F	0,3	0,4	0,8	5*	5*	50	319
CNX92	SOT-18F	0,3	0,4	0,8	5*	5*	50	319

* t_r/t_f.

OTHER OPTOELECTRONIC DEVICES

Infrared GaAs and GaAlAs emitter diodes

type	case	λ_p typ. (nm)	IF max. (mA)	I _{FRM} max. (mA)	V _R max. (V)	ϕ_e typ. (μ W)	I _e at (mW/sr)	IF (mA)	$\theta_{1/2}$ typ. (o)	t _r /t _f typ. (ns)	page
CQW89A	SOD-63D2	830	130	2500*	5	8000	> 9	100	40	30/30	405
CQW89A-1	SOD-63D2	830	130	2500*	5	8000	> 12	100	40	30/30	405
CQW89A-2	SOD-63D2	830	130	2500*	5	8000	> 15	100	40	30/30	405
CQY11B	TO-18	880	30	200 [▲]	2	100	0,064	20	70	30/30	411
CQY11C	TO-18	880	30	200 [▲]	2	50	1,25	20	7	30/30	415
CQY49B	TO-18	930	100	1000*	5		> 0,3	50	80	600/350	421
CQY49C	TO-18	930	100	1000*	5		> 3,0	50	15	600/350	421
CQY50	DO-31	930	100	500*	2	700	0,180	20	35	600/350	427
CQY52	DO-31	930	100	500*	2	1500	0,450	20	35	600/350	427
CQY53S	FO-81	690	50		3		1 ^{▲▲}	10	90		433
CQY58A	SOD-53F	930	50	200*	5	1000	> 2	20	20	3000/3000	437
CQY58A-1	SOD-53F	930	50	200*	5	1000	> 1	20	20	3000/3000	437
CQY58A-2	SOD-53F	930	50	200*	5	1000	3	20	20	3000/3000	437
CQY89A	SOD-63B2	930	130	1000**	5	12 000	> 9	100	40		443
CQY89A-1	SOD-63B2	930	130	1000**	5	12 000	> 12	100	40		443
CQY89A-2	SOD-63B2	930	130	1000**	5	12 000	> 15	100	40		443

* tp = \leq 10 μ s; δ = 0,01

** tp = 50 μ s; δ = 0,05

▲ tp = 100 μ s; δ = 0,1

▲▲ I_v = 1 mcd

Recommended combinations of emitters and receivers

emitter	receivers
CQY11B CQY11C	BPX29 BPX25
CQY49B CQY49C CQY50/52A CQY58A CQY58A-1 CQY58A-2	BPX29, BPX72 BPX25, BPX72 BPX71-203/204, BPW71 BPW22A-1, BPW22A-2 BPW22A-1, BPW22A-2 BPW22A-1, BPW22A-2
CQW89A CQW89A-1 CQW89A-2 CQY89A CQY89A-1 CQY89A-2	BPW50 BPW50 BPW50 BPW50 BPW50 BPW50

Photodiodes

type	case	λ_p typ. (nm)	VR max. (V)	I _L typ. (μ A)	VR ; (V)	E _e ; (mW/cm ²)	T _c (K) λ (nm)	I _R max. (nA)	at VR	A (mm ²)	page			
BPW50	SOD-67	930	32	45	5	1	930	30	10	5	347			
BPX40	see note	800	18	8*	4,75	4,75	2856	500	15	2,1	367			
BPX41		800	18	24*								15	6,3	373
BPX42		800	18	75*								15	24,8	379
BPX61 BPX61P	SOT-49/3 SOT-49/3	850 850	32 70	70 70	5	4,75	2856	30 1	10	6,75	385			

Note : Types BPX40 to BPX42 are unencapsulated. * BPX40,41 and 42 measured in photovoltaic mode, min values.

Phototransistors (NPN)

type	case	V _{CEO} max. (V)	I _C max. (mA)	I _L at (mA)	V _{CE} ; (V)	E _e ; (mW/cm ²)	T _c (K) λ(nm)*	I _{CEO} max. (μA)	at	V _{CE} (V)	page
BPW22A-1	SOD-53F	50	25	1,5 to 8	5	1	930*	0,1		30	341
BPW22A-2	SOD-53F	50	25	5 to 25	5	1	930*	0,1		30	341
BPX25	SOT-29/2	50	100	> 4	6	7,75	2856	0,1		24	361
BPX29	SOT-29/1	50	100	> 0,2	6	7,75	2856	0,1		24	361
BPX71	SOT-71A	50	20	0,5 to 15	5	20	2856	0,025		30	391
BPX71-204	SOT-71A	50	20	7 to 15	5	20	2856	0,025		30	391
BPX72	SOT-70A	50	25	0,5-3	5	4,75	2856	0,1		20	397
BPX72D	SOT-70A	50	25	0,85-3	5	4,75	2856	0,1		20	397
BPX72E	SOT-70A	50	25	1,4-3	5	4,75	2856	0,1		20	397
BPX72F	SOT-70A	50	25	2,4-5	5	4,75	2856	0,1		20	397

Photo-Darlington transistor

BPW71	SOT-71A	30	100	> 15	5	1	930*	0,1		10	353
-------	---------	----	-----	------	---	---	------	-----	--	----	-----

Lasers and fibre-optic components

type	description	page
CQF24	GaAlAs high intensity LED. Hermetic TO-46 header with microlens. Radiant power coupled in fibre of 200 μm core diameter is 400 μW at 830 nm.	457
516COF-B	GaAlAs multi-longitudinal mode diode laser coupled to a 50/125 μm graded index fibre; radiant output power 3 mW at 850 nm. Options also available for 820 and 870 nm.	487
502COF	Buried heterostructure InGaAsP laser diode emitting at 1,3 μm and coupled to a 50/125 μm graded index fibre. Built in SOT-191 together with a fast responding monitor diode.	475
503COF	Buried heterostructure InGaAsP laser diode coupled to a single mode fibre pigtail; radiant output power 1,5 mW at 1,3 μm .	479
COL10A	AlGaAs double heterostructure laser with photo p-i-n diode optically coupled to the rear facet; radiant output power 5 mW at 820 nm.	463
504COL	AlGaAs double heterostructure visible laser diode with photo p-i-n diode optically coupled to the rear facet; output power 5 mW at 780 nm.	483
COL13A	Collimator pen consisting of lens system and laser device with output power 2 mW.	467
COL16	Collimator pen consisting of lens system and laser device with output power 2 mW.	471
Receivers		
BPF24	Si photo p-i-n diode in hermetic sealed TO-46 header with microlens. Responsivity 0,4 A/W.	453

Infrared sensors

type	case	number of elements	element dimensions mm	spectral response μm	responsivity typ. V/W	N.E.P. typ. W/Hz ^{1/2}	page
RPY97	SOT-49H	2	2 x 1	6,5 to 14	(10 μm , 10) 150	(10 μm , 10,1) $1,5 \times 10^{-9}$	507
RPY100	SOT-49H	1	2 x 1	6 to 15	(10 μm , 10) 150	(10 μm , 10,1) $2,5 \times 10^{-9}$	517
RPY101	SOT-49H	1	2 x 1,5	6 to 15	(10 μm , 10) 150	(10 μm , 10,1) $3,8 \times 10^{-9}$	527
RPY102	SOT-49H	1	2 x 2	6 to 15	(10 μm , 10) 75	(10 μm , 10,1) 5×10^{-9}	537
RPY103	SOT-49H	2	2 x 1	6 to 15	(10 μm , 10) 150	(10 μm , 10,1) $2,2 \times 10^{-9}$	547
RPY107	SOT-49H	1	2 x 1	1 to 15	(500 K, 10) 130	(500 K, 10,1) $3,0 \times 10^{-9}$	557
RPY109	SOT-49H	1	2 x 2	1 to 15	(500 K, 10) 65	(500 K, 10,1) 6×10^{-9}	567
P2105	SOT-49G	1	2 x 2	1 to 25	(500 K, 10) 90	(500 K, 10,1) $1,4 \times 10^{-9}$	577

Fresnel lens

A low cost Fresnel lens array for use with sensors, suitable for general purpose movement sensing applications. It is designed to provide high sensitivity, long range monitoring up to at least 12 m, with 90° volumetric coverage.

Lens specification		page
Focal length	30,5 mm	583
Nominal coverage	12 m x 90°	
Number of monitored zones	A = 8 B = 4 C = 3	
Nominal average transmission	50 %	
Material	polyethylene	

TYPE NUMBER SURVEY

TYPE NUMBER SURVEY

In this alphanumeric list we present all optoelectronic devices mentioned in this handbook

	page
BP24	453
BPW22A	341
BPW50	347
BPW71	353
BPX25	361
BPX29	361
BPX40	367
BPX41	373
BPX42	379
BPX61	385
BPX61P	385
BPX71	391
BPX72	397
CNG35	53
CNG36	53
CNR36	67
CNX21	75
CNX35	83
CNX35U	99
CNX36	83
CNX36U	99
CNX38	115
CNX38U	131
CNX39	83
CNX39U	99
CNX44	299
CNX44A	309
CNX46	299
CNX48	147
CNX48U	159
CNX62	171
CNX72	183
CNX82	195
CNX83	207
CNX91	319
CNX92	319
CNY 17-1	7
CNY 17-2	7
CNY 17-3	7
CNY50	327
CNY57	219
CNY57A	219
CNY57AU	233
CNY57U	233
CNY62	247
CNY63	247
CQF24	457
CQL10A	463
CQL13A	467
CQL16	471
Photodiode for fibre-optic transmission, TO-46	453
Photosensitive transistor, SOD-53F	341
Photosensitive PIN diode for remote control, SOD-67	347
Photo-Darlington transistor, SOT-71	353
Phototransistor with lens, IR remote control, SOT-29/2	361
Phototransistor with plane window, IR remote control, SOT-29/1	361
Photodiode, sensitivity 14 nA/lx, unencapsulated	367
Photodiode, sensitivity 40 nA/lx, unencapsulated	373
Photodiode, sensitivity 150 nA/lx, unencapsulated	379
Photodiode, sensitivity, 35 μ A, SOT-49	385
Photodiode, sensitivity, 35 μ A, SOT-49	385
Phototransistor with glass lens, SOT-71A (D0-31)	391
Phototransistor with plastic lens, SOT-70A	397
Optocoupler, 4,4 kV, C.T.R. > 0,4, SOT-90B	53
Optocoupler, 4,4 kV, C.T.R. > 0,8, SOT-90B	53
Optocoupler, 4,4 kV, I_{OL} > 2 mA, SOT-97F	67
Optocoupler, 10 kV, C.T.R. > 0,2, SOT-211	75
Optocoupler, 4,4 kV, C.T.R. > 0,4, SOT-90B	83
Optocoupler, 4,4 kV, C.T.R. > 0,4, SOT-90B	99
Optocoupler, 4,4 kV, C.T.R. > 0,8, SOT-90B	83
Optocoupler, 4,4 kV, C.T.R. > 0,8, SOT-90B	99
Optocoupler, 4,4 kV, C.T.R. > 2,1, SOT-90B	115
Optocoupler, 4,4 kV, C.T.R. < 2,1, SOT-90B	131
Optocoupler, 4,4 kV, C.T.R. > 0,6, SOT-90B	83
Optocoupler, 4,4 kV, C.T.R. > 0,6, SOT-90B	99
Optocoupler, 1 kV, C.T.R. > 0,3, SOT-104C	299
Optocoupler, 1 kV, SOT-104C	309
Optocoupler, 1 kV, C.T.R. > 0,3, SOT-104C	299
Optocoupler, 4,4 kV, C.T.R. > 5, SOT-90B	147
Optocoupler, 4,4 kV, C.T.R. > 5, SOT-90B	159
Optocoupler, 5,3 kV, C.T.R. > 0,4, SOT-174	171
Optocoupler, 5,3 kV, C.T.R. > 0,4, SOT-90B	183
Optocoupler, 5,3 kV, C.T.R. > 0,4, SOT-212	195
Optocoupler, 5,3 kV, C.T.R. > 0,4, SOT-212	207
Optocoupler, 0,8 kV, SOT-18F	319
Optocoupler, 0,8 kV, SOT-18F	319
Optocoupler, 4,4 kV, C.T.R. > 0,4, SOT-90B	7
Optocoupler, 4,4 kV, C.T.R. > 0,63, SOT-90B	7
Optocoupler, 4,4 kV, C.T.R. > 1,0, SOT-90B	7
Optocoupler, 1 kV, C.T.R. > 2,5, SOT-104B	327
Optocoupler, 4,4 kV, C.T.R. > 0,2, SOT-90B	219
Optocoupler, 4,4 kV, C.T.R. > 0,4, SOT-90B	219
Optocoupler, 4,4 kV, C.T.R. > 0,4, SOT-90B	233
Optocoupler, 4,4 kV, C.T.R. > 0,2, SOT-90B	233
Optocoupler, 5,3 kV, C.T.R. > 0,25, SOT-91B	247
Optocoupler, 4,3 kV, C.T.R. > 0,50, SOT-91B	247
LED, IR, for fibre-optic transmissions, SOT-46	457
Laser diode, 5 mW, 820 nm, SOT-148	463
Collimator pen, 2 mW, 820 nm	467
Collimator pen, 2 mW, 780 nm	471

TYPE NUMBER SURVEY

	page
CQW89A	405
CQY11B	411
CQY11C	415
CQY49B	421
CQY49C	421
CQY50	427
CQY52	427
CQY53S	433
CQY58A	437
CQY89A	443
Fresnel lens	583
H11A1	259
H11A2	259
H11A3	259
H11A4	259
H11A5	5
H11B1	7
H11B2	7
H11B3	7
H11B255	7
MCA230	8
MCA231	8
MCA255	8
MCT2	265
MCT26	271
P044/44A	277
P2105	577
RPY97	507
RPY100	517
RPY101	527
RPY102	537
RPY103	547
RPY107	557
RPY109	567
SL5500	9
SL5501	9
SL5502R	10
SL5504	10
SL5511	10
SL5505S	11
4N25	291
4N25A	291
4N26	291
4N27	291
4N28	291
4N35	5
4N36	5
4N37	5
4N38	6
4N38A	6
502CQF	475
503CQF	479
504CQL	483
516CQF-B	487

GENERAL

Safety recommendations

Rating system

Letter symbols

Type designation

Definitions

Current transfer ratio

Switching times

Approvals/recognitions

GENERAL SAFETY RECOMMENDATIONS OPTOELECTRONIC DEVICES

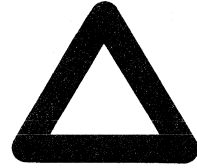

1. GENERAL

When properly used and handled, optoelectronic devices do not constitute a risk to health or environment. Modern high technology materials have been used in the manufacture of these devices to ensure optimum performance. Some of these materials are toxic in certain circumstances. Mechanical or electrical damage is unlikely to give rise to any hazard, but toxic vapours may be generated if the devices are heated to destruction and it is important that the following recommendations are observed.

Care should be taken to ensure that all personnel who may handle, use or dispose of these products are aware of the necessary precautions.

Individual product data sheets will indicate whether any specific hazards are likely to be present.

2. DISPOSAL

These devices should be disposed of in accordance with the relevant legislation; in the United Kingdom disposal should therefore be carried out in accordance with the Deposit of Poisonous Waste Act 1972 and the Control of Pollution Act 1974, or with the latest legislation.

3. FIRE

Optoelectronic devices themselves, when used within the specified limits, do not present a fire hazard.

Devices can contain arsenic, beryllium, lead, mercury, selenium, tellurium or similar hazardous materials or compounds, which, if exposed to high temperatures may emit toxic or noxious fumes.

Most packaging materials are flammable and care should be taken in the disposal of such materials, some of which will emit toxic fumes if burned.

4. HANDLING

Care must be exercised with those devices incorporating glass or plastic. If these devices are broken, precautions must be taken against the following hazards that may arise:

Broken glass or ceramic. Protective clothing such as gloves should be worn.

Contamination from toxic materials and vapours. In particular, skin contact and inhalation must be avoided.

Access to live contacts which may be at high potential. Devices must be isolated from the mains supply prior to their removal.

5. BERYLLIUM COMPOUNDS

Beryllium oxide dust is toxic if inhaled or if particles enter a cut or an abrasion. At all times avoid handling beryllium oxide ceramics; if they are touched, the hands must be washed thoroughly with soap and water. Do nothing to beryllium oxide ceramics that may produce dust or fumes.

Care should be taken upon eventual disposal that they are not thrown out with general industrial waste. Users seeking disposal of devices incorporating beryllium oxide ceramics should first take advice from the manufacturer's service department.

This potential hazard is present at all times from receipt to disposal of devices.

→ 6. OTHER COMPOUNDS

Other compounds, such as those containing arsenic, indium, lead, lithium, selenium, tantalum, tellurium etc., may be toxic by ingestion or inhalation.

The above information and recommendations are given in good faith and are in accordance with the best knowledge and opinion available at the date of the compilation of the data sheets.

RATING SYSTEMS

The rating systems described are those recommended by the International Electrotechnical Commission (IEC) in its Publication 134.

DEFINITIONS OF TERMS USED

Electronic device. An electronic tube or valve, transistor or other semiconductor device.

Note

This definition excludes inductors, capacitors, resistors and similar components.

Characteristic. A characteristic is an inherent and measurable property of a device. Such a property may be electrical, mechanical, thermal, hydraulic, electro-magnetic, or nuclear, and can be expressed as a value for stated or recognized conditions. A characteristic may also be a set of related values, usually shown in graphical form.

Bogey electronic device. An electronic device whose characteristics have the published nominal values for the type. A bogey electronic device for any particular application can be obtained by considering only those characteristics which are directly related to the application.

Rating. A value which establishes either a limiting capability or a limiting condition for an electronic device. It is determined for specified values of environment and operation, and may be stated in any suitable terms.

Note

Limiting conditions may be either maxima or minima.

Rating system. The set of principles upon which ratings are established and which determine their interpretation.

Note

The rating system indicates the division of responsibility between the device manufacturer and the circuit designer, with the object of ensuring that the working conditions do not exceed the ratings.

ABSOLUTE MAXIMUM RATING SYSTEM

Absolute maximum ratings are limiting values of operating and environmental conditions applicable to any electronic device of a specified type as defined by its published data, which should not be exceeded under the worst probable conditions.

These values are chosen by the device manufacturer to provide acceptable serviceability of the device, taking no responsibility for equipment variations, environmental variations, and the effects of changes in operating conditions due to variations in the characteristics of the device under consideration and of all other electronic devices in the equipment.

The equipment manufacturer should design so that, initially and throughout life, no absolute maximum value for the intended service is exceeded with any device under the worst probable operating conditions with respect to supply voltage variation, equipment component variation, equipment control adjustment, load variations, signal variation, environmental conditions, and variations in characteristics of the device under consideration and of all other electronic devices in the equipment.

DESIGN MAXIMUM RATING SYSTEM

Design maximum ratings are limiting values of operating and environmental conditions applicable to a bogey electronic device of a specified type as defined by its published data, and should not be exceeded under the worst probable conditions.

These values are chosen by the device manufacturer to provide acceptable serviceability of the device, taking responsibility for the effects of changes in operating conditions due to variations in the characteristics of the electronic device under consideration.

The equipment manufacturer should design so that, initially and throughout life, no design maximum value for the intended service is exceeded with a bogey device under the worst probable operating conditions with respect to supply voltage variation, equipment component variation, variation in characteristics of all other devices in the equipment, equipment control adjustment, load variation, signal variation and environmental conditions.

DESIGN CENTRE RATING SYSTEM

Design centre ratings are limiting values of operating and environmental conditions applicable to a bogey electronic device of a specified type as defined by its published data, and should not be exceeded under normal conditions.

These values are chosen by the device manufacturer to provide acceptable serviceability of the device in average applications, taking responsibility for normal changes in operating conditions due to rated supply voltage variation, equipment component variation, equipment control adjustment, load variation, signal variation, environmental conditions, and variations in the characteristics of all electronic devices.

The equipment manufacturer should design so that, initially, no design centre value for the intended service is exceeded with a bogey electronic device in equipment operating at the stated normal supply voltage.

LETTER SYMBOLS FOR TRANSISTORS AND SIGNAL DIODES

based on IEC Publication 148

LETTER SYMBOLS FOR CURRENTS, VOLTAGES AND POWERS

Basic letters

The basic letters to be used are:

I, i = current
V, v = voltage
P, p = power.

Lower-case basic letters shall be used for the representation of instantaneous values which vary with time.

In all other instances upper-case basic letters shall be used.

Subscripts

A, a	Anode terminal
(AV), (av)	Average value
B, b	Base terminal, for MOS devices; Substrate
(BR)	Breakdown
C, c	Collector terminal
D, d	Drain terminal
E, e	Emitter terminal
F, f	Forward
G, g	Gate terminal
K, k	Cathode terminal
M, m	Peak value
O, o	As third subscript: The terminal not mentioned is open circuited
R, r	As first subscript: Reverse. As second subscript: Repetitive. As third subscript: With a specified resistance between the terminal not mentioned and the reference terminal.
(RMS), (rms)	R. M. S. value
S, s	{ As first or second subscript: Source terminal (for FETS only) As second subscript: Non-repetitive (not for FETS) As third subscript: Short circuit between the terminal not mentioned and the reference terminal
X, x	Specified circuit
Z, z	Replaces R to indicate the actual working voltage, current or power of voltage reference and voltage regulator diodes.

Note: No additional subscript is used for d.c. values.

Upper-case subscripts shall be used for the indication of:

- a) continuous (d. c.) values (without signal)
Example I_B
- b) instantaneous total values
Example i_B
- c) average total values
Example $I_{B(AV)}$
- d) peak total values
Example I_{BM}
- e) root-mean-square total values
Example $I_{B(RMS)}$

Lower-case subscripts shall be used for the indication of values applying to the varying component alone:

- a) instantaneous values
Example i_b
- b) root-mean-square values
Example $I_{b(rms)}$
- c) peak values
Example I_{bm}
- d) average values
Example $I_{b(av)}$

Note: If more than one subscript is used, subscript for which both styles exist shall either be all upper-case or all lower-case.

Additional rules for subscripts

Subscripts for currents

Transistors: If it is necessary to indicate the terminal carrying the current, this should be done by the first subscript (conventional current flow from the external circuit into the terminal is positive).

Examples: I_B , i_B , i_b , I_{bm}

Diodes: To indicate a forward current (conventional current flow into the anode terminal) the subscript F or f should be used; for a reverse current (conventional current flow out of the anode terminal) the subscript R or r should be used.

Examples: I_F , I_R , i_F , $I_{f(rms)}$

Subscripts for voltages

Transistors: If it is necessary to indicate the points between which a voltage is measured, this should be done by the first two subscripts. The first subscript indicates the terminal at which the voltage is measured and the second the reference terminal or the circuit node. Where there is no possibility of confusion, the second subscript may be omitted.

Examples: V_{BE} , v_{BE} , v_{be} , V_{bem}

Diodes: To indicate a forward voltage (anode positive with respect to cathode), the subscript F or f should be used; for a reverse voltage (anode negative with respect to cathode) the subscript R or r should be used.

Examples: V_F , V_R , v_F , V_{rm}

Subscripts for supply voltages or supply currents

Supply voltages or supply currents shall be indicated by repeating the appropriate terminal subscript.

Examples: V_{CC} , I_{EE}

Note: If it is necessary to indicate a reference terminal, this should be done by a third subscript

Example: V_{CCE}

Subscripts for devices having more than one terminal of the same kind

If a device has more than one terminal of the same kind, the subscript is formed by the appropriate letter for the terminal followed by a number; in the case of multiple subscripts, hyphens may be necessary to avoid misunderstanding.

Examples: I_{B2} = continuous (d. c.) current flowing into the second base terminal

V_{B2-E} = continuous (d. c.) voltage between the terminals of second base and emitter

Subscripts for multiple devices

For multiple unit devices, the subscripts are modified by a number preceding the letter subscript; in the case of multiple subscripts, hyphens may be necessary to avoid misunderstanding.

Examples: I_{2C} = continuous (d. c.) current flowing into the collector terminal of the second unit

V_{1C-2C} = continuous (d. c.) voltage between the collector terminals of the first and the second unit.

Application of the rules

The figure below represents a transistor collector current as a function of time. It consists of a continuous (d.c.) current and a varying component.

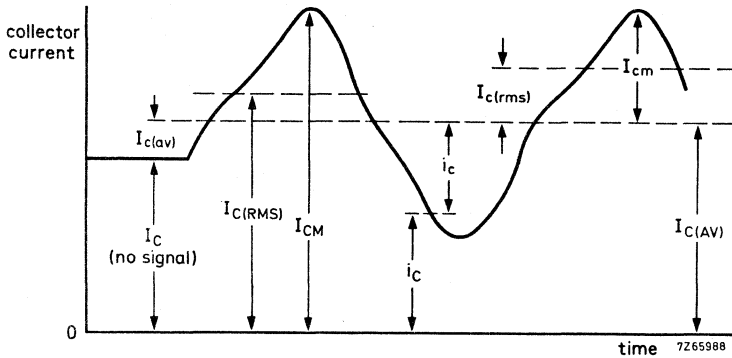

LETTER SYMBOLS FOR ELECTRICAL PARAMETERS

Definition

For the purpose of this Publication, the term "electrical parameter" applies to four-pole matrix parameters, elements of electrical equivalent circuits, electrical impedances and admittances, inductances and capacitances.

Basic letters

The following is a list of the most important basic letters used for electrical parameters of semiconductor devices.

- B, b = susceptance; imaginary part of an admittance
- C = capacitance
- G, g = conductance; real part of an admittance
- H, h = hybrid parameter
- L = inductance
- R, r = resistance; real part of an impedance
- X, x = reactance; imaginary part of an impedance
- Y, y = admittance;
- Z, z = impedance;

Upper-case letters shall be used for the representation of:

- a) electrical parameters of external circuits and of circuits in which the device forms only a part;
- b) all inductances and capacitances.

Lower-case letters shall be used for the representation of electrical parameters inherent in the device (with the exception of inductances and capacitances).

Subscripts

General subscripts

The following is a list of the most important general subscripts used for electrical parameters of semiconductor devices:

F, f	= forward; forward transfer
I, i (or 1)	= input
L, l	= load
O, o (or 2)	= output
R, r	= reverse; reverse transfer
S, s	= source

Examples: Z_S , h_I , h_F

The upper-case variant of a subscript shall be used for the designation of static (d.c.) values.

Examples: h_{FE} = static value of forward current transfer ratio in common-emitter configuration (d.c. current gain)

R_E = d.c. value of the external emitter resistance.

Note: The static value is the slope of the line from the origin to the operating point on the appropriate characteristic curve, i.e. the quotient of the appropriate electrical quantities at the operating point.

The lower-case variant of a subscript shall be used for the designation of small-signal values.

Examples: h_{fe} = small-signal value of the short-circuit forward current transfer ratio in common-emitter configuration

$Z_e = R_e + jX_e$ = small-signal value of the external impedance

Note: If more than one subscript is used, subscripts for which both styles exist shall either be all upper-case or all lower-case

Examples: h_{FE} , y_{RE} , h_{fe}

Subscripts for four-pole matrix parameters

The first letter subscript (or double numeric subscript) indicates input, output, forward transfer or reverse transfer

Examples: h_i (or h_{11})
 h_o (or h_{22})
 h_f (or h_{21})
 h_r (or h_{12})

A further subscript is used for the identification of the circuit configuration. When no confusion is possible, this further subscript may be omitted.

Examples: h_{fe} (or h_{21e}), h_{FE} (or h_{21E})

Distinction between real and imaginary parts

If it is necessary to distinguish between real and imaginary parts of electrical parameters, no additional subscripts should be used. If basic symbols for the real and imaginary parts exist, these may be used.

Examples: $Z_i = R_i + jX_i$
 $y_{fe} = g_{fe} + jb_{fe}$

If such symbols do not exist or if they are not suitable, the following notation shall be used:

Examples: $\text{Re}(h_{ib})$ etc. for the real part of h_{ib}
 $\text{Im}(h_{ib})$ etc. for the imaginary part of h_{ib}

PRO ELECTRON TYPE DESIGNATION CODE
FOR SEMICONDUCTOR DEVICES

This type designation code applies to discrete semiconductor devices – as opposed to integrated circuits –, multiples of such devices and semiconductor chips.

“Although not all type numbers accord with the Pro Electron system, the following explanation is given for the ones that do.”

A basic type number consists of:

TWO LETTERS FOLLOWED BY A SERIAL NUMBER

FIRST LETTER

The first letter gives information about the material used for the active part of the devices.

- A. GERMANIUM or other material with band gap of 0,6 to 1,0 eV.
- B. SILICON or other material with band gap of 1,0 to 1,3 eV.
- C. GALLIUM-ARSENIDE or other material with band gap of 1,3 eV or more.
- R. COMPOUND MATERIALS (e.g. Cadmium-Sulphide).

SECOND LETTER

The second letter indicates the function for which the device is primarily designed.

- A. DIODE; signal, low power
- B. DIODE; variable capacitance
- C. TRANSISTOR; low power, audio frequency ($R_{th j-mb} > 15 K/W$)
- D. TRANSISTOR; power, audio frequency ($R_{th j-mb} \leq 15 K/W$)
- E. DIODE; tunnel
- F. TRANSISTOR; low power, high frequency ($R_{th j-mb} > 15 K/W$)
- G. MULTIPLE OF DISSIMILAR DEVICES – MISCELLANEOUS; e.g. oscillator
- H. DIODE; magnetic sensitive
- L. TRANSISTOR; power, high frequency ($R_{th j-mb} \leq 15 K/W$)
- N. PHOTO-COUPLER
- P. RADIATION DETECTOR; e.g. high sensitivity phototransistor
- Q. RADIATION GENERATOR; e.g. light-emitting diode (LED)
- R. CONTROL AND SWITCHING DEVICE; e.g. thyristor, low power ($R_{th j-mb} > 15 K/W$)
- S. TRANSISTOR; low power, switching ($R_{th j-mb} > 15 K/W$)
- T. CONTROL AND SWITCHING DEVICE; e.g. thyristor, power ($R_{th j-mb} \leq 15 K/W$)
- U. TRANSISTOR; power, switching ($R_{th j-mb} \leq 15 K/W$)
- X. DIODE; multiplier, e.g. varactor, step recovery
- Y. DIODE; rectifying, booster
- Z. DIODE; voltage reference or regulator (transient suppressor diode, with third letter W)

SERIAL NUMBER

Three figures, running from 100 to 999, for devices primarily intended for consumer equipment.*
One letter (Z, Y, X, etc.) and two figures, running from 10 to 99, for devices primarily intended for industrial/professional equipment.*

This letter has no fixed meaning except W, which is used for transient suppressor diodes.

VERSION LETTER

It indicates a minor variant of the basic type either electrically or mechanically. The letter never has a fixed meaning, except letter R, indicating reverse voltage, e.g. collector to case or anode to stud.

SUFFIX

Sub-classification can be used for devices supplied in a wide range of variants called associated types. Following sub-coding suffixes are in use:

1. VOLTAGE REFERENCE and VOLTAGE REGULATOR DIODES: *ONE LETTER and ONE NUMBER*

The LETTER indicates the nominal tolerance of the Zener (regulation, working or reference) voltage

- A. 1% (according to IEC 63: series E96)
- B. 2% (according to IEC 63: series E48)
- C. 5% (according to IEC 63: series E24)
- D. 10% (according to IEC 63: series E12)
- E. 20% (according to IEC 63: series E6)

The number denotes the typical operating (Zener) voltage related to the nominal current rating for the whole range.

The letter 'V' is used instead of the decimal point.

2. TRANSIENT SUPPRESSOR DIODES: *ONE NUMBER*

The NUMBER indicates the maximum recommended continuous reversed (stand-off) voltage V_R . The letter 'V' is used as above.

3. CONVENTIONAL and CONTROLLED AVALANCHE RECTIFIER DIODES and THYRISTORS: *ONE NUMBER*

The NUMBER indicates the rated maximum repetitive peak reverse voltage (V_{RRM}) or the rated repetitive peak off-state voltage (V_{DRM}), whichever is the lower. Reversed polarity is indicated by letter R, immediately after the number.

4. RADIATION DETECTORS: *ONE NUMBER*, preceded by a hyphen (-)

The NUMBER indicates the depletion layer in μm . The resolution is indicated by a version LETTER.

5. ARRAY OF RADIATION DETECTORS and GENERATORS: *ONE NUMBER*, preceded by a stroke (/).

The NUMBER indicates how many basic devices are assembled into the array.

* When these serial numbers are exhausted the serial number for consumer types may be extended to four figures, and that for industrial types to three figures.

DEFINITIONS FOR OPTOELECTRONIC DEVICES ACCORDING TO IEC 306

DEFINITIONS AND UNITS VALID FOR INFRARED RADIATION

Radiant flux, radiant power ϕ , P, (ϕ_e)

This is the power emitted, transferred or received as radiation, i.e. the radiant energy (dQ_e) emitted per second.

$$\phi_e = \frac{dQ_e}{dt} \quad \text{unit: watt, W}$$

Radiant intensity I_e , I

For a source of given direction, the radiant intensity is the radiant power leaving the source, or an element of the source, in an element of solid angle (Ω) containing the given direction, divided by that element of solid angle.

$$I_e = \frac{d\phi_e}{d\Omega} \quad \text{unit: watt per steradian, W/sr}$$

Irradiance E, (E_e)

At a point on a surface, the irradiance is the radiant power incident on an element of the surface containing the point divided by the area (A) of that element.

$$E = \frac{d\phi_e}{dA} \quad \text{unit: watt per square metre, W/m}^2$$

DEFINITIONS AND UNITS VALID FOR VISIBLE LIGHT

This is radiation capable of stimulating the eye. Exceptions to this definition are made where necessary in the data sheets, e.g. dark and light currents of a phototransistor and light rise time of a near-infrared light emitting diode.

Luminous flux ϕ , (ϕ_v)

The luminous flux $d\phi$ of a source of luminous intensity I_v in an element of solid angle of $d\Omega$, is given by:

$$d\phi = I_v \cdot d\Omega \quad \text{unit: lumen, lm}$$

Lumen

This is the luminous flux radiating from a point source of uniform luminous intensity of 1 candela, contained within a solid angle of 1 steradian.

$$1 \text{ lm} = 1 \text{ cd}\cdot\text{sr}$$

Luminous intensity I_v , (I)

For a source of given direction, the luminous intensity is the luminous flux leaving the source, or an element of the source, in an element of solid angle (Ω) containing the given direction, divided by that element of solid angle.

$$I_v = \frac{d\phi_v}{d\Omega} \quad \text{unit: candela, cd}$$

Candela

This is the luminous intensity in a given direction, of a source emitting monochromatic radiation at a frequency of 540×10^{12} Hz*, the radiant intensity of which, in that direction, being 1/683 W/sr.

* Approximately 555 nm.

Illuminance E_v , (E)

At a point on a surface, the illuminance is the luminous flux incident on an element of the surface containing the point, divided by the area (A) of that element.

$$E_v = \frac{d\phi_v}{dA} \quad \text{unit: lux, lx}$$

Lux lx

This is the illumination produced when 1 lumen of flux falls on a surface of area 1 square metre. It will be seen that an illumination of 1 lx is produced on a area of 1 square metre at a distance of 1 metre from a point source of 1 candela.

Distribution temperature T_d

This is the temperature of a black body at which the spectral radiation distribution of the radiator under consideration, in a given wavelength range, is proportional or approximately proportional to the spectral radiation distribution of the black body. If the wavelength range given includes visible radiation, then the distribution temperature corresponds to the colour temperature.

Colour temperature T_c

The colour temperature of a radiator is the temperature of a black body which has the same, or approximately the same, spectral radiation distribution in the visible range as the radiator under consideration.

DEFINITIONS OF ELECTRICAL QUANTITIES

Photocurrent I_{ph}

This is the change in output current from the photocathode due to incident radiation.

Dark current I_d

This is the current flowing in a photoelectric device in the absence of illumination.

Dark current equivalent radiation E_d

This is the incident radiation required to give a d.c. signal output current equal to the dark current.

Quantum efficiency

This is the ratio of the number of emitted photoelectrons to the number of incident photons. Quantum efficiency (Q.E.) at a given wavelength of incident radiation may be calculated as follows:

$$\text{Q.E.} = \frac{\text{constant} \times S_k}{\lambda}$$

where S_k = spectral sensitivity (A/W) at wavelength λ
 λ = wavelength of incident radiation (nm)

$$\text{constant} = \frac{hc}{e} = 1,24 \times 10^3 \text{ W.nm/A}$$

h = Planck's constant ($6,6256 \times 10^{-34}$ js)

c = velocity of electromagnetic waves in vacuo = $2,997925 \times 10^8$ m/s

e = elementary charge = $1,60210 \times 10^{-19}$ coulomb or $4,80298 \times 10^{-19}$ e.s.u.

Saturation voltage V_{CEsat}

This is the lowest operating voltage which causes no change in photocurrent when this voltage is increased with constant radiation.

Saturation current I_{CEsat}

This is the output current of a photosensitive device which is not changed by an increase of either:

- a. the irradiance under constant operating conditions, or,
- b. the operating voltage under constant irradiance.

Thermal resistance

This is the ratio of temperature rise to power dissipation or

$$R_{th\ j-a} = \frac{T_j - T_{amb}}{P_{tot}}$$

The thermal resistance is also the reciprocal of the derating factor.

Pulsed operation

Under these conditions higher peak power dissipation is possible. In general, the shorter the pulse and lower the frequency, the lower is the temperature that the junction reaches.

By analogy with thermal resistance:

$$Z_{th\ j-a} = \frac{T_j - T_{amb}}{P_{tot}}$$

DEFINITIONS OF SENSITIVITY

These definitions apply more directly to photocathode sensitivity. For devices in which it is necessary to define the anode (overall) sensitivity, the signal output current should be considered instead of the photocurrent.

Activity of radiation Z

This is the ratio of the sensitivity to a given radiation to the sensitivity to a reference radiation.

Radiant sensitivity S_R

This may be expressed as either:

- a. the ratio of the photocurrent of the device to the incident radiant power, expressed in amperes per watt (A/W), or,
- b. the ratio of the photocurrent of the device to the incident irradiance, expressed in amperes per watt per square metre (A/W/m²).

Absolute spectral sensitivity $s(\lambda)$

This is the radiant sensitivity for monochromatic radiation of a stated wavelength.

Relative spectral sensitivity $s(\lambda)_{rel}$

This is the ratio of the radiant sensitivity at a particular wavelength to the radiant sensitivity at a reference wavelength, usually the wavelength of maximum response.

Note

For non-linear detectors, it is necessary to refer to constant photocurrent at all wavelengths.

Luminous sensitivity S_L

This may be expressed as either:

- a. the ratio of the photocurrent of the device to the incident luminous flux, expressed in amperes per lumen (A/lm), or,
- b. the ratio of the photocurrent of the device to the incident illuminance, expressed in amperes per lux (A/lx).

Dynamic sensitivity S_D

Under stated operating conditions, this is the ratio of the variation of the photocurrent of the device to the initiating small variation in the incident radiant or luminous power.

Note

Distinction is made between luminous dynamic sensitivity and radiant sensitivity.

Spectral sensitivity characteristics

This is the relationship, usually shown in graphical form, between the wavelength and the absolute or relative spectral sensitivity.

Absolute spectral sensitivity characteristics

This is the relationship, usually shown in graphical form, between the wavelength and the absolute spectral sensitivity.

Relative spectral sensitivity characteristics

This is the relationship between wavelength and the relative spectral sensitivity.

Quantum efficiency characteristic

This is the relationship, usually shown in graphical form, between the wavelength and the quantum efficiency.

DEFINITIONS OF TIME QUANTITIES

Rise time t_r

This is the time required for the photocurrent to rise from a stated low percentage to a stated higher percentage of the maximum value when a steady state of radiation is instantaneously applied. It is usual to consider the 10% and 90% levels (see Figs 1 and 2).

Fall time t_f

This is the time required for the photocurrent to fall from a stated high percentage to a stated lower percentage of the maximum value when the steady state of radiation is instantaneously removed.

It is usual to consider the 90% and 10% levels (see Figs 1 and 2).

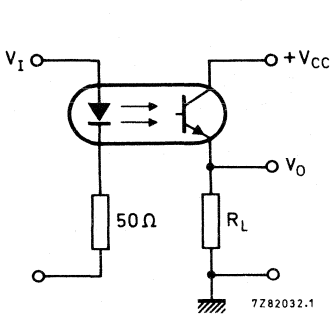

Fig. 1 Switching circuit.

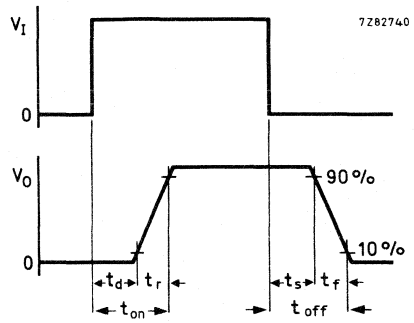

Fig. 2 Waveforms.

DEFINITIONS AND UNITS OF INFRARED SENSITIVE DEVICES

Emissivity

This is the ratio of the radiant exitance of a thermal radiator to that of a black body radiator at the same temperature.

Absolute refractive index n

This is the ratio of the velocity of light in vacuo to that in a particular medium. For most practical purposes the velocity of light in vacuo can be replaced by that in air.

Detectivity

This is the signal-to-noise ratio per unit radiant power. Thus it is the reciprocal of the N.E.P. Care must be exercised when considering detectivity as this term has also been used in the definitions of D*.

unit: 1/watts (1/W)

D*

This is an independent figure of merit which is defined as the r.m.s. signal-to-noise ratio in a 1 Hz bandwidth per unit r.m.s. incident radiant power per square root of detector area. Unless otherwise stated, it is assumed that the detector field of view is hemispherical (2 π steradian).

unit: cm√Hz/W

Wave number

This is the reciprocal of the wavelength in centimetres. ($\frac{1}{\lambda}$)

N.E.P. (Noise Equivalent Power)

This is the r.m.s. value of the incident, chopped, radiant power necessary to produce an r.m.s. signal to r.m.s. noise ratio of unity. The r.m.s. noise refers to the value calculated for unit square root bandwidth $\sqrt{\text{Hz}}$.

unit: W/√Hz

Responsivity

This is the ratio of the r.m.s. signal in volts to the r.m.s. value of the incident, chopped, radiant power.

unit: V/W

Noise equivalent irradiation

This is the value of incident radiation which, when modulated in a stated manner, produces a signal output power equal to the noise power, both of which are in a stated bandwidth.

Radiance L_e

This is the radiant intensity (I_e) at a point on a surface and in a given direction, of an element of that surface, divided by the area of the orthogonal projection of the element on a plane perpendicular to the given direction.

unit: watt per steradian square metre, $W/sr.m^2$

Radiant exitance (radiant emittance) M_e

At a point on a surface, this is the radiant power leaving an element of that surface, divided by the area of the element.

$$M_e = \frac{d\phi_e}{dA} \quad \text{unit: watt per square metre, } W/m^2$$

Luminous exitance (luminous emittance) M_v

At a point on a surface, this is the luminous flux leaving an element of that surface, divided by the area of that element.

$$M_v = \frac{d\phi_v}{dA} \quad \text{unit: lumen per square metre, } lm/m^2$$

Luminance L_v

This is the luminous intensity (I_v) at a point on a surface and in a given direction, of an element of that surface divided by the area of the orthogonal projection of the element on a plane perpendicular to the given direction.

unit: candela per square metre, cd/m^2

Steradian sr (see Fig. 3)

This is the solid angle subtended at the centre of a sphere by an element of the surface area equal to the square of the radius of the sphere. There are, therefore, 4π steradians in a complete sphere.

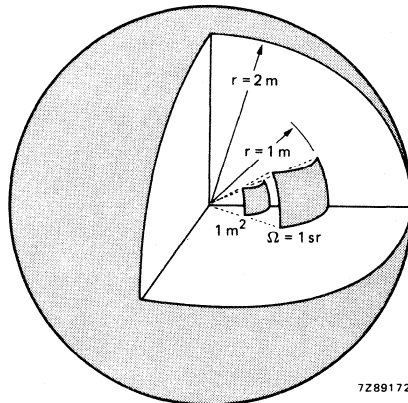

Fig. 3.

7289172

ADDITIONAL DEFINITIONS FOR OPTOCOUPLERS

Input current I_i

Current flowing in the input terminals corresponding, in most cases, to the forward current of the LED (I_F).

Output current I_o

Current flowing in the output terminals corresponding, in most cases, to the collector current of the transistor.

Transfer matrix

The output expressed as a function of the input is

$$V_o = AV_i + Bi_i$$

$$i_o = CV_i + Di_i$$

which can be expressed as the matrix

$$M = \begin{pmatrix} V_o \\ i_o \end{pmatrix} = \begin{pmatrix} A & B \\ C & D \end{pmatrix} \begin{pmatrix} v_i \\ i_i \end{pmatrix}$$

the general transfer matrix.

Transfer ratio τ

The transfer ratio is derived from

$$V_o/V_i = A$$

$$i_o/V_i = C$$

$$V_o \approx Bi_i$$

$$i_o \approx Di_i$$

and $\tau = i_i/i_e$ for a given V_o

The ratio is usually expressed as a factor.

Isolation voltage V_{IORM}

The maximum voltage that can be applied between the short-circuited input terminals and the short-circuited output terminals. The type of voltage must be specified, i.e. direct, alternating or repetitive peak.

Repetitive peak voltage rating indicates the resistance to transients. If exceeded, this can result in irreversible damage to the device.

Working voltage V_Z

The maximum voltage that may be applied continuously between the input and the output of the device under normal operating conditions without altering its characteristics.

Collector cut-off current (dark) I_{CEW}

The collector cut-off (dark) current at a defined V_{CC} and a defined working voltage V_Z applied between the short-circuited leads of the IR diode and the emitter of the transistor.

Input and output capacitance C_{iO}

The capacitance between the input terminals and the output terminals.

Insulation resistance R_{iO}

The resistance between the input terminals and the output terminals.

Common-mode rejection ratio CMRR

The ratio between a common-mode voltage and the output voltage expressed in dB. The coupling, mainly capacitive, reduces the value.

$$CMRR = 20 \log \frac{V_o}{V_{cm}}$$

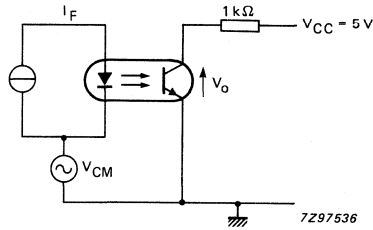

Fig. 1.

Linearity

Linearity depends on both the emitter and receiver characteristics. The characteristics of the transistor are shown in Fig. 2, those of the diode are shown in Fig. 3.

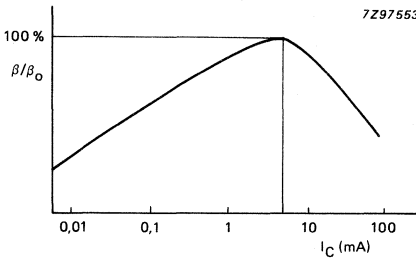

Fig. 2.

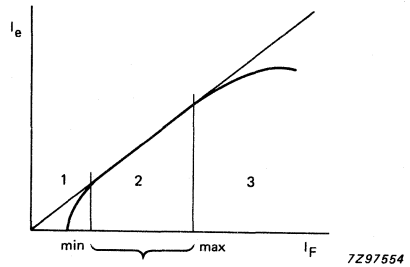

Fig. 3.

Zone 1 shows the non-linearity caused by the non-radiative current of the LED being greater than the radiative current. Non-linearity in zone 3 is caused by saturation.

DEFINITIONS OF TIME QUANTITIES

Switching times

Switching times are defined for a square input pulse, V_i .

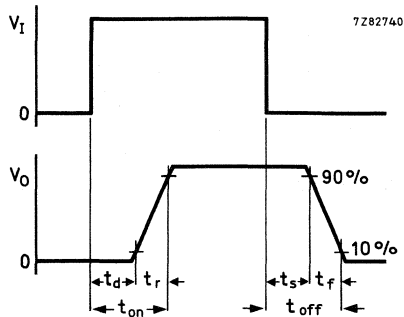

Fig. 4 Waveforms.

Delay time t_d

The time elapsing between the start of the pulse and the moment when the output signal reaches 10% of its maximum value.

Rise time t_r

The time elapsing between the moment when the output signal is 10% of its maximum value and the moment when it reaches 90% of this value.

Turn-on time t_{on}

The time elapsing between the start of the pulse and the moment when the corresponding output signal is 90% of its maximum value.

$$t_{on} = t_d + t_r$$

Storage time t_s

The time elapsing between the end of the input pulse and the moment when the corresponding output signal drops by 10% of its maximum value (or the time when it is still 90%).

Fall time t_f

The time elapsing between the moment when the output signal is still 90% of its maximum value and the moment when it is no more than 10%.

Turn-off time t_{off}

The time elapsing between the end of the input pulse and the moment when the corresponding output signal falls to 10% of its maximum value.

$$t_{off} = t_s + t_f$$

Propagation delay times

High-Low propagation delay time t_{pHL}

for TTL: The time between the specified reference points on the input and output waveforms with the output changing from the defined HIGH level to the defined LOW level.

for CMOS: The time between the specified reference points, normally the 50% points on the input and output waveforms, with the output changing from the defined HIGH level to the defined LOW level.

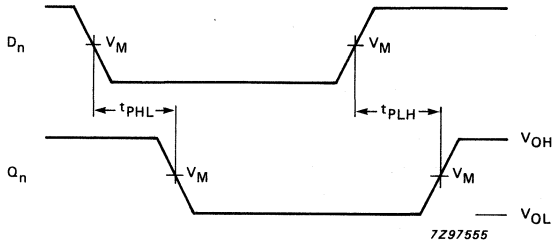

Fig. 5 TTL.

Low-High propagation delay time t_{pLH}

for TTL: The time between the specified reference points on the input and output waveforms with the output changing from the defined LOW level to the defined HIGH level.

for CMOS: The time between the specified reference points, normally the 50% points on the input and output waveforms, with the output changing from the defined LOW level to the defined HIGH level.

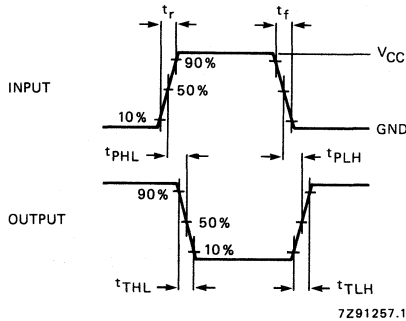

Fig. 6 CMOS.

PARAMETERS INFLUENCING THE CURRENT TRANSFER RATIO OF AN OPTOCOUPLER

Our optocouplers are frequently specified at $V_{CE} = 0,4 \text{ V}$, $I_F = 10 \text{ mA}$. Many other suppliers specify the transfer ratio at $V_{CE} = 5 \text{ V}$ or even 10 V when, in fact, the C.T.R. can be much higher. In comparing Philips optocouplers with alternative types a correction factor should be applied.

The current transfer ratio I_C/I_F (CTR) of an optocoupler depends mainly on the biasing conditions of the LED and phototransistor.

The curve of Fig. 1 shows a typical example of the I_C/I_F (CTR) at different I_F and V_{CE} values. The I_C/I_F (CTR) is normalized at 1 for $I_F = 10 \text{ mA}$, $V_{CE} = 0,4 \text{ V}$ and for a high I_C/I_F (CTR).

If the base of the device is accessible, it is possible to limit the I_C/I_F (CTR) by wiring a resistance R_{BE} between the base and emitter. This resistance provides a threshold and thus limits the noise at the optocoupler output.

The curve of Fig. 2 shows three zones:

1. The phototransistor is OFF and only the current of the collector-base photodiode is available.
2. The phototransistor is just at the limit of conduction.
3. The phototransistor is ON and the collector current is no longer dependent on R_{BE} .

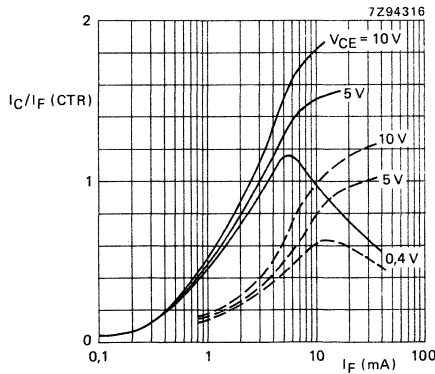

Fig. 1.

- Piece with a high I_C/I_F (CTR)
- - - Piece with a low I_C/I_F (CTR)

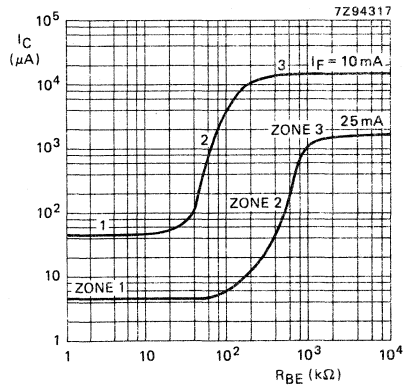

Fig. 2 $V_{CC} = 5 \text{ V}$; $T_{amb} = 25 \text{ }^\circ\text{C}$; typical values.

OPTOCOUPLER SWITCHING TIMES

The curves published for each optocoupler type refer to the non-saturating mode. It is possible to choose the collector current and the load resistance R_L corresponding to the desired switching times.

In the saturation mode, the switching times depend on the forward current I_F , the load resistance R_L and an extra resistance R_{BE} which may be connected between the base and emitter of the photo-transistor. This greatly improves the speed of the circuit.

Fig. 1 shows the typical switching times as a function of R_L without R_{BE} .

Fig. 2 shows these times as a function of I_F without R_{BE} and with $R_{BE} = 100 \text{ k}\Omega$.

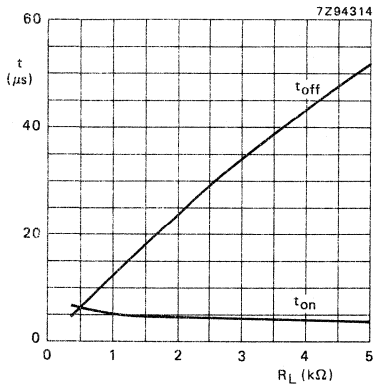

Fig. 1 $V_{CC} = 5 \text{ V}$; $I_F = 10 \text{ mA}$.

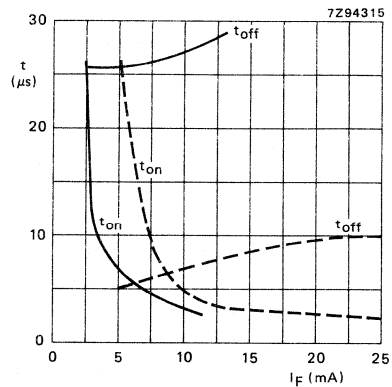

Fig. 2 $V_{CC} = 5 \text{ V}$; $R_L = 2,5 \text{ k}\Omega$.

— $R_{BE} = \infty$
 - - - $R_{BE} = 100 \text{ k}\Omega$

APPROVALS/RECOGNITIONS

See data sheets for file and certificate numbers

	UL	VDE 0883	VDE 0804	VDE 0860	others
CNG35					
CNG36					
CNR36					
CNX21					
CNX35					
CNX35U	x	x	x	x	
CNX36					
CNX36U	x	x	x	x	
CNX38					
CNX38U	x	x	x	x	
CNX39					
CNX39U	x	x	x	x	
CNX44					
CNX44A					
CNX46					
CNX48					
CNX48U	x	x	x	x	
CNX62	x	x	x	x	(see note 1)
CNX72	x	x	x	x	
CNX82	x	x	x	x	(see note 2)
CNX83	pending	pending	pending	pending	
CNX91					
CNX92					
CNY17-1	pending	x	x	x	
CNY17-2	pending	x	x	x	
CNY17-3	pending	x	x	x	
CNY50					
CNY57					
CNY57A					
CNY57AU	x	x	x	x	
CNY57U	x	x	x	x	
CNY62					
CNY63					
H11A1	x	x			
H11A2	x	x			
H11A3	x	x			
H11A4	x	x			
H11A5	pending	x			
H11B1	pending	x			
H11B2	pending	x			
H11B3	pending	x			

GENERAL

	UL	VDE 0883	VDE 0804	VDE 0860	others
H11B255	pending	x			
MCA230	pending	x			
MCA231	pending	x			
MCA255	pending	x			
MCT2	x	x	x	x	
MCT26	x	x	x	x	
PO40/44A					British Telecom (see note 3)
SL5500					French CNET
SL5501					French CNET
SL5502R					French CNET
SL5504					French CNET
SL5511					French CNET
SL5505S					French CNET
4N25	x	x			CNET approval pending
4N25A	x	x			
4N26	x	x			
4N27	x	x			
4N28	x	x			
4N35	pending	x	x	x	
4N36	pending	x			
4N37	pending	x			
4N38	pending	x			
4N38A	pending	x			

Note 1 Application approval based on video game G2700/. . . by Nordic countries. Approved by BSI for standard BS415-1979.

Note 2 Approvals for Nordic countries and BSI pending.

Note 3 This type PO40/44A can replace each individual type PO40A, PO41A, PO42A, PO43A and PO44A.

SECTION A1

Optocouplers in a plastic encapsulation

DEVELOPMENT DATA

This data sheet contains advance information and specifications are subject to change without notice.

CNG35
CNG36

GaAlAs OPTOCOUPLERS

Optically coupled isolators consisting of an infrared emitting GaAlAs diode and a silicon n-p-n photo-transistor with accessible base in a SOT-90B envelope, designed for low input current and long life operation.

The application of an IR emitting diode, based on a special GaAlAs (intrinsic) process results in a perfect linearity at low input currents and a very low degradation during the device's operating life.

QUICK REFERENCE DATA

Diode

Forward current (d.c.) I_F max. 100 mA

Transistor

Collector-emitter voltage (open base) V_{CEO} max. 30 V

Optocoupler

Output/input d.c. current transfer ratio (C.T.R.)

$I_F = 10 \text{ mA}; V_{CE} = 0,4 \text{ V}$

CNG35 I_C/I_F min. 0,4

CNG36 I_C/I_F min. 0,8

$I_F = 500 \mu\text{A}; V_{CE} = 0,4 \text{ V}$

CNG35 I_C/I_F min. 0,1

CNG36 I_C/I_F min. 0,2

Leakage current under working voltage
2,5 kV d.c. value; $V_{CC} = 10 \text{ V}$

I_{CEW} max. 200 nA

Isolation voltage

V_{IORM} min. 4,4 kV(d.c.)
3,12 kV(r.m.s.)

MECHANICAL DATA

SOT-90B (see Fig. 1).

MECHANICAL DATA

Fig. 1 SOT-90B.

Dimensions in mm

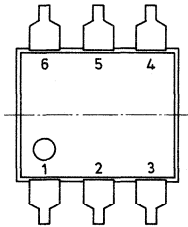
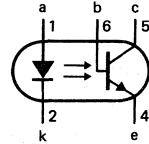
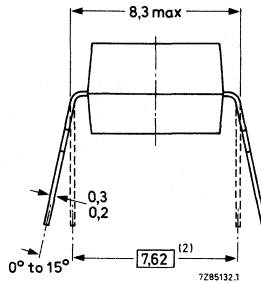
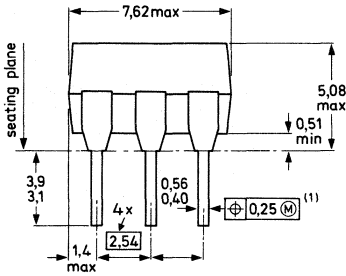

⊕ Positional accuracy.

(M) Maximum Material Condition.

- (1) Centre-lines of all leads are within $\pm 0,125$ mm of the nominal position shown; in the worst case, the spacing between any two leads may deviate from nominal by 0,25 mm.
- (2) When the leads are parallel, the tips are in position for automatic insertion.

RATINGS

Limiting values in accordance with the Absolute Maximum System (IEC 134)

Diode

Continuous reverse voltage

V_R max. 5 V

Forward current

I_F max. 100 mA

d.c.

I_{FRM} max. 2,5 A

(peak value); $t_p = 10 \mu s$; $\delta = 0,01$

Total power dissipation

P_{tot} max. 200 mW

up to $T_{amb} = 25 \text{ }^\circ\text{C}$

Transistor

Collector-emitter voltage (open base)

V_{CE0} max. 30 V

Collector-base voltage (open emitter)

V_{CB0} max. 70 V

Emitter-collector voltage (open base)

V_{ECO} max. 7 V

Collector current

I_C max. 100 mA

Total power dissipation

P_{tot} max. 200 mW

up to $T_{amb} = 25 \text{ }^\circ\text{C}$

Optocoupler

Storage temperature	T_{stg}	-55 to +150 °C
Junction temperature	T_j	max. 125 °C
Lead soldering temperature up to the seating plane; $t_{sld} < 10$ s	T_{sld}	max. 260 °C

THERMAL RESISTANCE

From junction to ambient in free air			
diode	$R_{th\ j-a}$	max.	500 K/W
transistor	$R_{th\ j-a}$	max.	500 K/W
From junction to ambient, device mounted on a printed circuit board			
diode	$R_{th\ j-a}$	max.	400 K/W
transistor	$R_{th\ j-a}$	max.	400 K/W

ISOLATION RELATED VALUES

External air gap (clearance) input terminals to output terminals	$L(1O1)$	min.	7,2 mm
External tracking path (creepage distance) input terminals to output terminals	$L(1O2)$	min.	7,0 mm
Tracking resistance (KB-value)			KB-100/A

CHARACTERISTICS

$T_j = 25$ °C unless otherwise specified

Diode

Forward voltage $I_F = 10$ mA	V_F	typ.	1,45 V
		max.	1,75 V
Reverse current $V_R = 5$ V	I_R	max.	10 μ A

Transistor

Collector-emitter breakdown voltage open base; $I_C = 1$ mA	$V(BR)_{CEO}$	min.	30 V
Collector-base breakdown voltage open emitter; $I_C = 0,1$ mA	$V(BR)_{CBO}$	min.	70 V
Emitter-collector breakdown voltage open base; $I_E = 0,1$ mA	$V(BR)_{ECO}$	min.	7 V
Collector cut-off current (dark) $V_{CE} = 10$ V	I_{CEO}	typ.	2 nA
		max.	50 nA
$V_{CE} = 10$ V; $T_{amb} = 70$ °C	I_{CEO}	max.	10 μ A
$V_{CB} = 10$ V	I_{CBO}	max.	20 nA

DEVELOPMENT DATA

CNG35 CNG36

Optocoupler

Collector current

at $T_{amb} = 0\text{ }^{\circ}\text{C}$ to $70\text{ }^{\circ}\text{C}$

$V_F = 0,8\text{ V}$; $V_{CE} = 15\text{ V}$

$I_F = 2\text{ mA}$; $V_{CE} = 0,4\text{ V}$

$I_{CE(L)}$	max.	15 μA
$I_{CE(L)}$	min.	250 μA

Collector-emitter saturation voltage

$I_F = 10\text{ mA}$; $I_C = 2\text{ mA}$

CNG35	V_{CEsat}	typ.	0,15 V
		max.	0,4 V

$I_F = 10\text{ mA}$; $I_C = 4\text{ mA}$

CNG36	V_{CEsat}	typ.	0,19 V
		max.	0,4 V

Output capacitance

$V_{CB} = 10\text{ V}$; $f = 1\text{ MHz}$

C_{bc}	typ.	4,5 pF
----------	------	-----------------

Collector current at

working voltage $V_W = 2,5\text{ kV}$;

(d.c. value) see notes 1 and 2

$V_{CC} = 10\text{ V}$; $T_j = 25\text{ }^{\circ}\text{C}$

$V_{CC} = 10\text{ V}$; $T_j = 70\text{ }^{\circ}\text{C}$

I_{CEW}	max.	200 nA
I_{CEW}	max.	100 μA

Isolation voltage

(see note 3)

V_{IORM}	min.	4,4 kV(d.c.) 3,12 kV(r.m.s.)
------------	------	---

Capacitance between input and output

$V = 0$; $f = 1\text{ MHz}$

C_{io}	typ.	0,6 pF
----------	------	-----------------

Insulation resistance between input and output

$\pm V_{IO} = 1\text{ kV}$

r_{IO}	min.	$10^{10}\ \Omega$
	typ.	$10^{12}\ \Omega$

Switching times (see figures 3 and 4)

$I_C = 2\text{ mA}$; $V_{CC} = 5\text{ V}$; $R_L = 100\ \Omega$

Turn-on time

Turn-off time

CNG35	t_{on}	typ.	3 μs
	t_{off}	typ.	3 μs

$I_C = 2\text{ mA}$; $V_{CC} = 5\text{ V}$, $R_L = 1\text{ k}\Omega$

Turn-on time

Turn-off time

CNG35	t_{on}	typ.	12 μs
	t_{off}	typ.	12 μs

$I_C = 2\text{ mA}$; $V_{CC} = 5\text{ V}$; $R_L = 100\ \Omega$

Turn-on time

Turn-off time

CNG36	t_{on}	typ.	8 μs
	t_{off}	typ.	6 μs

$I_C = 2\text{ mA}$; $V_{CC} = 5\text{ V}$, $R_L = 1\text{ k}\Omega$

Turn-on time

Turn-off time

CNG36	t_{on}	typ.	20 μs
	t_{off}	typ.	18 μs

		CNG35	CNG36
D.C. current transfer ratio (C.T.R.) $I_F = 10 \text{ mA}; V_{CE} = 0,4 \text{ V}$	min.	0,4	0,8
	typ.	0,7	1,0
	max.	1,6	
$I_F = 2 \text{ mA}; V_{CE} = 0,4 \text{ V}$	I_C/I_F typ.	0,9	1,4
	I_C/I_F min.	0,1	0,2
$I_F = 0,5 \text{ mA}; V_{CE} = 0,4 \text{ V}$	I_C/I_F typ.	0,5	0,8
	I_C/I_F min.		

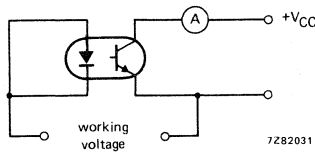

Fig. 2.

DEVELOPMENT DATA

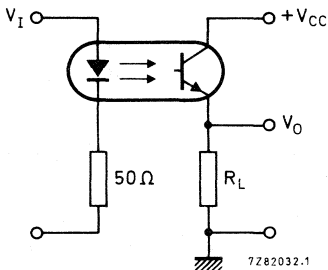

Fig. 3 Switching circuit.

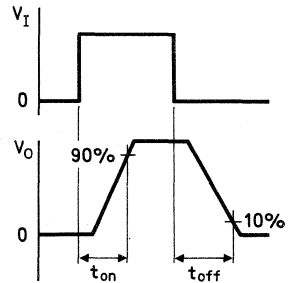

Fig. 4 Waveforms.

Notes.

1. This parameter is the maximum collector-emitter leakage current measured when a high voltage is applied between the emitter and the two shorted diode leads.
2. As quality assurance (on a sample basis), these parameters are covered by a 1000 hour reliability test.
3. Tested on sample basis. The input diode leads are shorted together and all the transistor leads shorted together, then a test voltage of 4,4 kV (d.c.) is applied for 1 min.

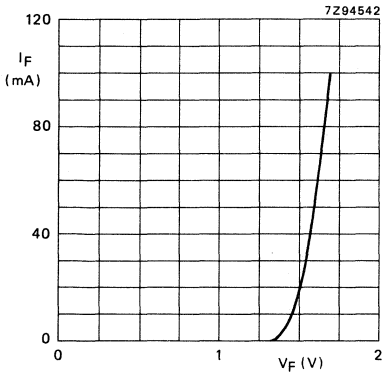

Fig. 5 $T_{amb} = 25\text{ }^\circ\text{C}$; typical values.

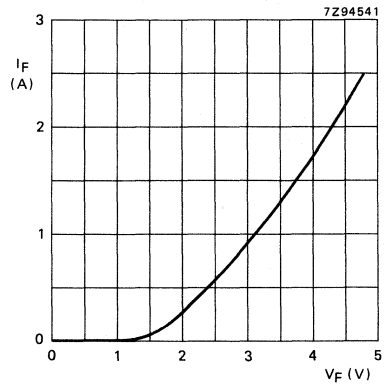

Fig. 6 $T_{amb} = 25\text{ }^\circ\text{C}$; $t_p = 10\text{ }\mu\text{s}$; $T = 1\text{ ms}$; typical values.

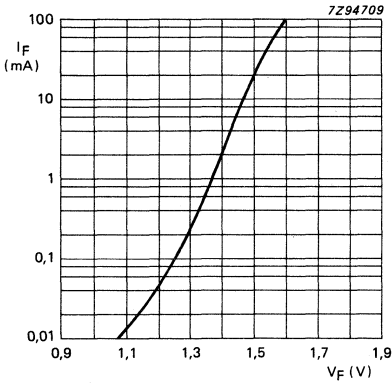

Fig. 7 $T_{amb} = 25\text{ }^\circ\text{C}$; typical values.

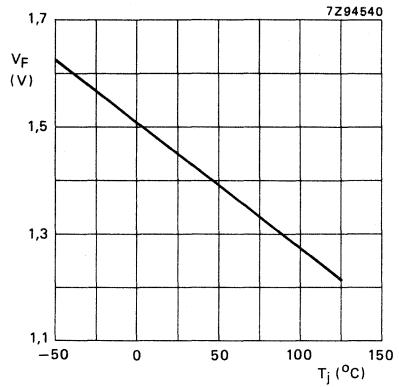

Fig. 8 $I_F = 10\text{ mA}$; typical values.

DEVELOPMENT DATA

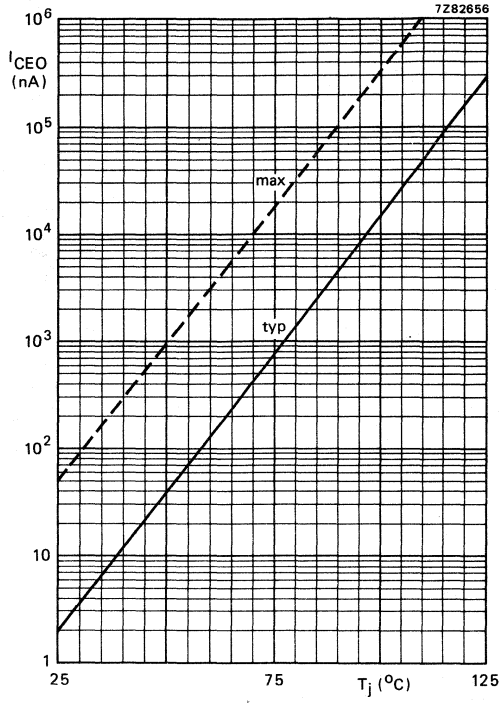

Fig. 9 $I_F = 0$; $V_{CE} = 10$ V.

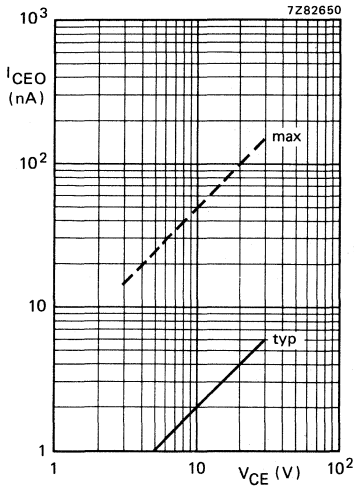

Fig. 10 $I_F = 0$; $T_j = 25$ °C.

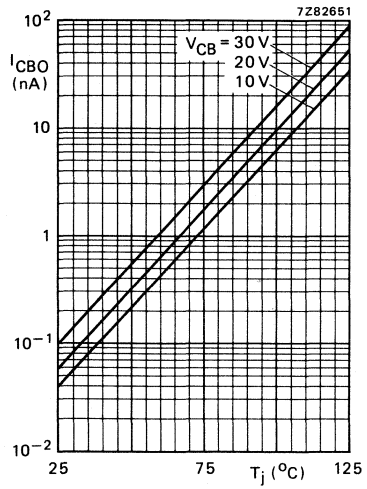

Fig. 11 Typical values.

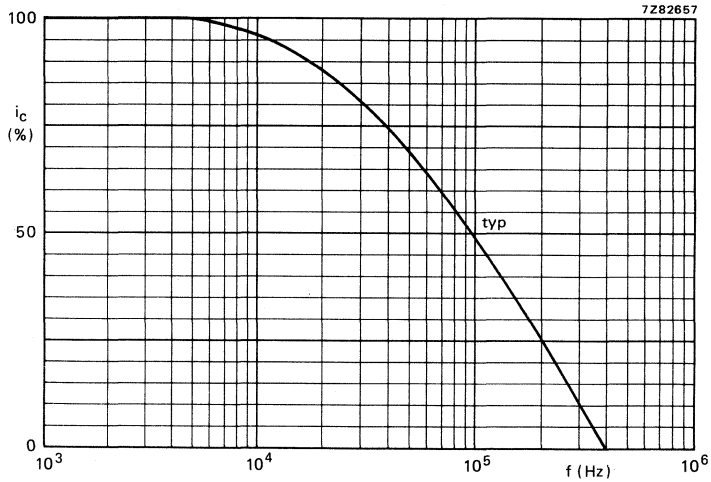

Fig. 12 $I_B = 0$; $I_C = 2$ mA; $V_{CC} = 5$ V; $R_L = 1$ k Ω ; $T_{amb} = 25$ °C.

DEVELOPMENT DATA

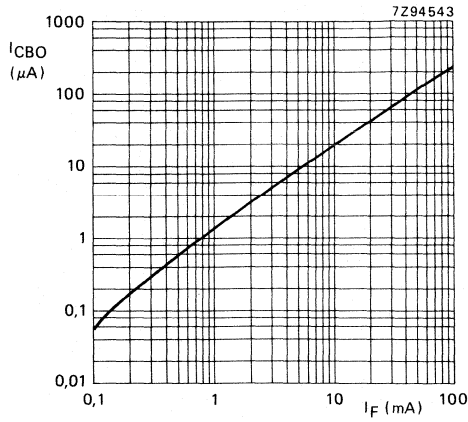

Fig. 13 $V_{CB} = 5 V$; $T_{amb} = 25 ^\circ C$; typical values.

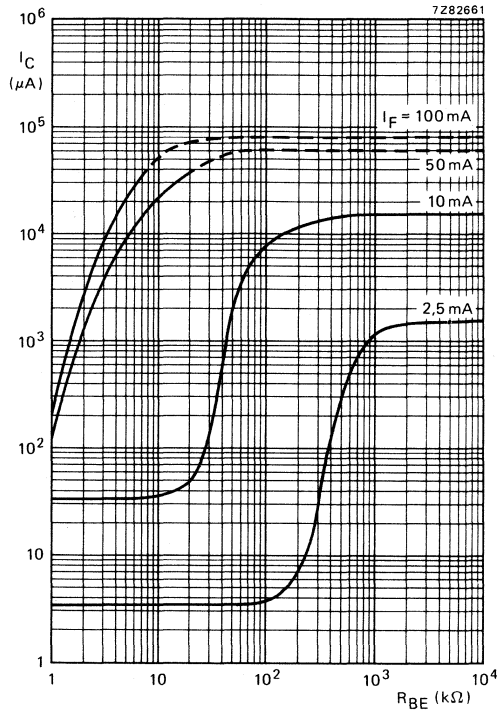

Fig. 14 $I_B = 0$; $V_{CE} = 5$ V; $T_{amb} = 25$ °C; typical values.

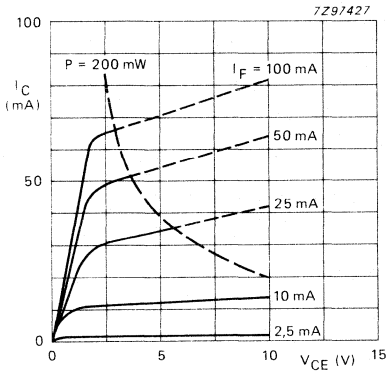

Fig. 15 $T_{amb} = 25 \text{ }^\circ\text{C}$, typical values; CNG35.

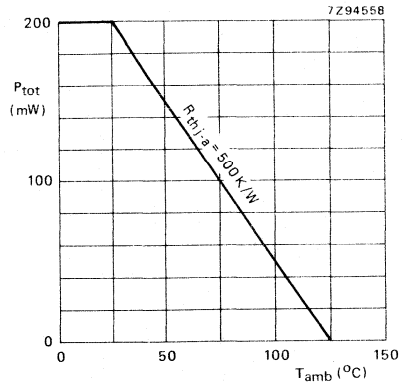

Fig. 16.

DEVELOPMENT DATA

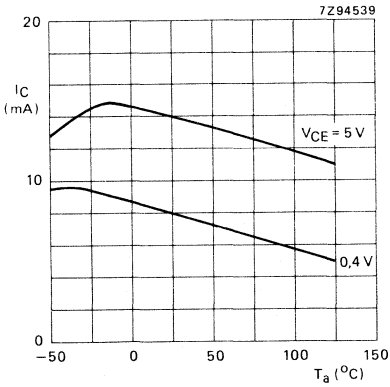

Fig. 17 $I_F = 10 \text{ mA}$; typical values; CNG35.

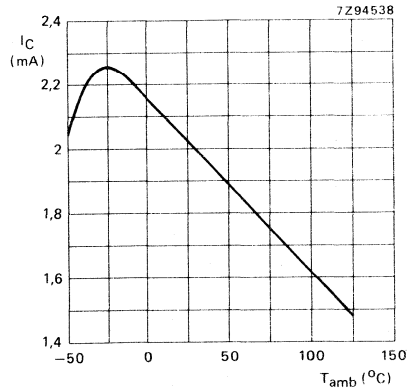

Fig. 18 $I_F = 2 \text{ mA}$; $V_{CE} = 0,4 \text{ V}$; typical values; CNG35.

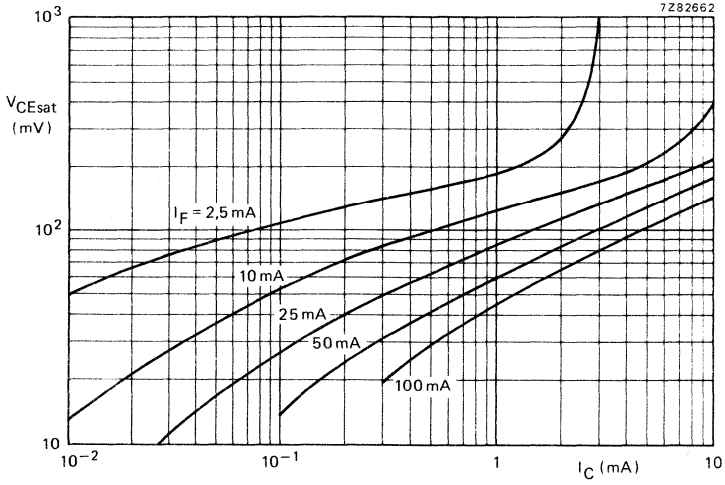

Fig. 19 $I_B = 0$; $T_{amb} = 25^\circ C$; typical values.

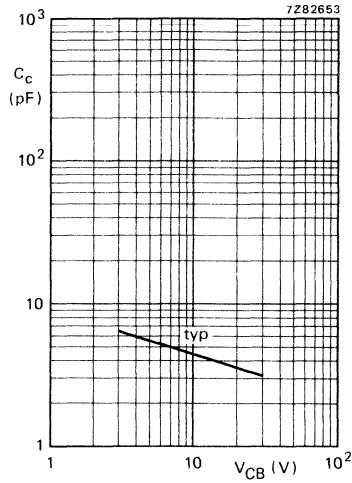

Fig. 20 $f = 1$ MHz; $T_{amb} = 25^\circ C$.

DEVELOPMENT DATA

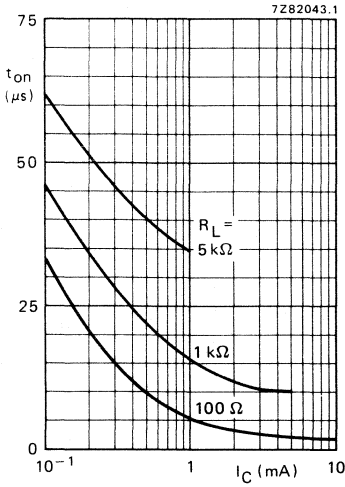

Fig. 21 $I_B = 0$; $V_{CC} = 5\text{ V}$; $T_{amb} = 25\text{ }^\circ\text{C}$; typical values. (See also Fig. 23); CNG35.

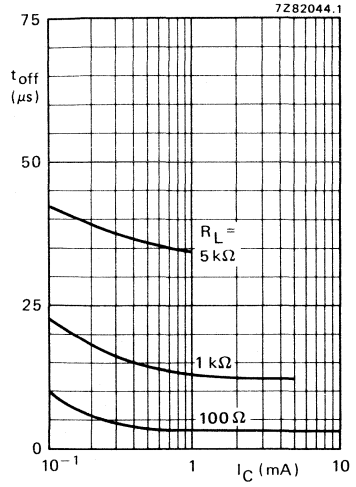
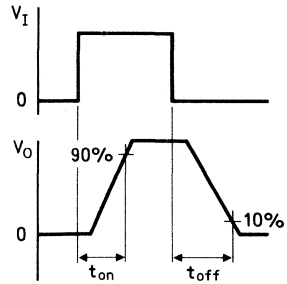
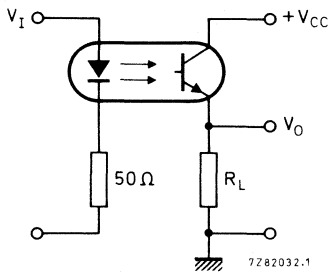

Fig. 22 $I_B = 0$; $V_{CC} = 5\text{ V}$; $T_{amb} = 25\text{ }^\circ\text{C}$; typical values. (See also Fig. 23); CNG35.



7Z67238.2

Fig. 23 Switching circuit and waveforms.

DEVELOPMENT DATA

This data sheet contains advance information and specifications are subject to change without notice.

CNR36

HIGH-SPEED OPTOCOUPLER

The CNR36 is a fast switching optocoupler consisting of a GaAlAs light emitting diode which is optically coupled to an integrated silicon photodetector in an 8-pin dual-in-line (DIL) envelope SOT-97F. It is suitable for use with TTL integrated circuits.

Features

- short propagation delay times
- low saturation voltage
- high isolation voltage of 2,5 kV (r.m.s.) and 3,5 kV (d.c.)
- working voltage of 2,5 kV (d.c.)
- high transient immunity

QUICK REFERENCE DATA

Diode

Continuous reverse voltage	V_R	max.	5 V
Forward current	I_F	max.	100 mA
d.c.	I_{FM}	max.	1 A
peak value; $t_{ON} = 1 \mu s$			

Transistor

Collector-emitter breakdown voltage	$V_{(BR)CEO}$	min.	18 V
$I_C = 10 \text{ mA}$			

Optocoupler

Output current	I_{OL}	min.	2 mA
$I_F = 10 \text{ mA}; V_{CC} = 4,5 \text{ V}; V_o = 0,4 \text{ V}$		typ.	4 mA
Logic low output voltage	V_{OL}	typ.	0,2 V
$I_F = 10 \text{ mA}; V_{CC} = 4,5 \text{ V}; I_o = 2 \text{ mA}$		max.	0,4 V
Propagation delay time	t_{PHL}	max.	0,8 μs
	t_{PLH}	max.	0,8 μs
Common mode transient immunity	$\pm CM$	min.	1 kV/ μs
Isolation voltage	V_{IORM}	min.	3,5 kV(d.c.) 2,5 kV(r.m.s.)

MECHANICAL DATA

SOT-97F (see Fig. 1).

MECHANICAL DATA

Fig. 1 SOT-97F.

Dimensions in mm

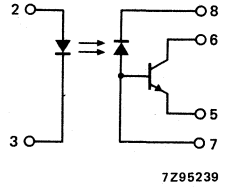
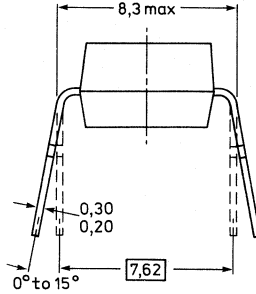
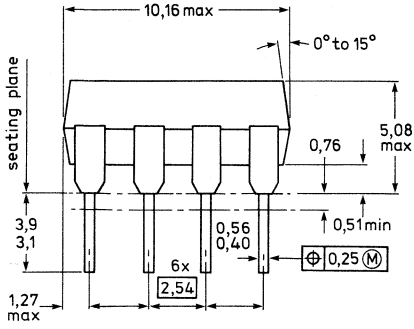

7295240

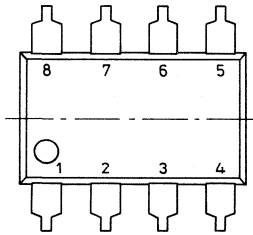

⊕ Positional accuracy.

Ⓜ Maximum Material Condition.

- (1) Centre-lines of all leads are within $\pm 0,125$ mm of the nominal position shown; in the worst case, the spacing between any two leads may deviate from the nominal by 0,25 mm.
- (2) When the leads are parallel, the tips remain in position for automatic insertion.

RATINGS

Limiting values in accordance with the Absolute Maximum System (IEC 134)

Diode

Continuous reverse voltage	V_R	max.	5 V
Forward current			
d.c.	I_F	max.	100 mA
(peak value); $t_p = 1 \mu s$	I_{FM}	max.	1 A
Total power dissipation up to $T_{amb} = 25 \text{ }^\circ\text{C}$	P_{tot}	max.	250 mW

Transistor

Emitter-base voltage	V_{EBO}	max.	5 V
Collector-emitter breakdown voltage			
$I_C = 10 \text{ mA}$	$V_{(BR)CEO}$	min.	18 V
Emitter-base breakdown voltage	$V_{(BR)EBO}$	min.	5 V
Collector current (d.c.)	I_C	max.	10 mA
Total power dissipation up to $T_{amb} = 85 \text{ }^\circ\text{C}$	P_{tot}	max.	100 mW

Optocoupler

Storage temperature	T_{stg}	-55 to +150 °C
Operating junction temperature	T_j	max. 125 °C
Lead soldering temperature up to the seating plane; $t_{slid} < 10$ s	T_{slid}	max. 260 °C

THERMAL RESISTANCE

From junction to ambient in free air diode	$R_{th\ j-a}$	=	500 K/W
transistor	$R_{th\ j-a}$	=	500 K/W
From junction to ambient, with the device mounted on a printed circuit board diode	$R_{th\ j-a}$	=	400 K/W
transistor	$R_{th\ j-a}$	=	400 K/W

CHARACTERISTICS

$T_j = 25$ °C unless otherwise specified

Diode

Forward voltage $I_F = 10$ mA	V_F	typ. max.	1,65 V 1,9 V
Reverse current $V_R = 5$ V	I_R	max.	10 μ A

Transistor (diode: $I_F = 0$)

Collector-emitter breakdown voltage at $I_C = 10$ mA	$V_{(BR)CEO}$	min.	18 V
Collector-base breakdown voltage* at $I_C = 100$ μ A	$V_{(BR)CBh}$	min.	30 V
Emitter-base breakdown voltage at $I_E = 0,1$ mA	$V_{(BR)EBO}$	min.	5 V
Logic high output current $I_F = 0$; $V_o = V_{CC} = 5,5$ V	I_{OH}	typ. max.	5 nA 500 nA
Logic high output current $I_F = 0$; $V_o = V_{CC} = 15$ V	I_{OH}	max.	100 μ A
Logic high supply current $I_F = 0$; $I_o = 0$; $V_{CC} = 15$ V	I_{CCH}	max.	1 μ A
Logic low supply current $I_F = 10$ mA; $V_{CC} = 15$ V	I_{CCL}	typ.	20 μ A

Optocoupler

Output current $I_F = 10$ mA; $V_{CC} = 4,5$ V; $V_o = 0,4$ V	I_{OL}	min. typ.	2 mA 4 mA
--	----------	--------------	--------------

* Cathode connected to collector

DEVELOPMENT DATA

Logic low output voltage

$I_F = 10 \text{ mA}; V_{CC} = 4,5 \text{ V}; I_o = 2 \text{ mA}$

V_{OL} typ. 0,2 V
 max. 0,4 V

Isolation voltage (note 2)

V_{IORM} min. 3,5 kV(d.c.)
 2,5 kV(r.m.s.)

Capacitance between input and output

$f = 1 \text{ MHz}$

C_{io} typ. 0,6 pF

Insulation resistance between input and output

$\pm V_{IO} = 1 \text{ kV}$

r_{IO} min. $10^{10} \Omega$
 typ. $10^{12} \Omega$

Switching times (see Figs 2 and 3)

$I_F = 10 \text{ mA}; V_{CC} = 5 \text{ V}; R_L = 2,5 \text{ k}\Omega$

Propagation delay time to logic low at output

t_{PHL} typ. 0,5 μs
 max. 0,8 μs

Propagation delay time to logic high at output

t_{PLH} typ. 0,4 μs
 max. 0,8 μs

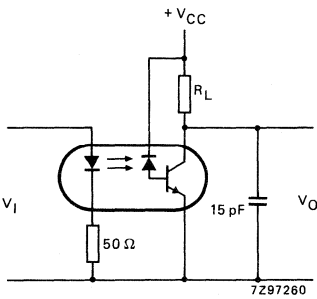

Fig. 2 Switching circuit.

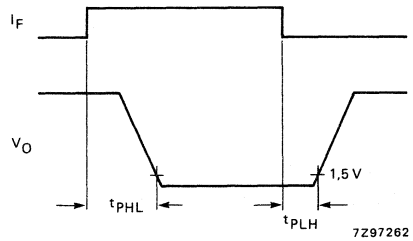

Fig. 3 Waveforms.

Switching times (see Figs 4 and 5)

$I_{Con} = 2 \text{ mA}; V_{CC} = 5 \text{ V}; R_L = 100 \Omega$

Turn-on time

t_{on} typ. 0,85 μs

Turn-off time

t_{off} typ. 0,85 μs

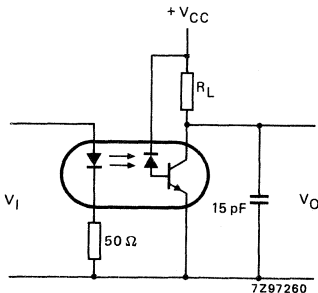

Fig. 4 Switching circuit.

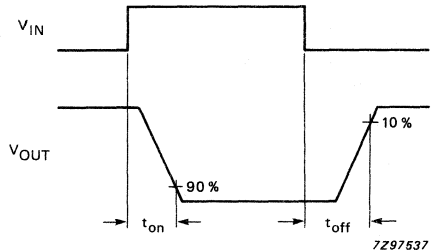

Fig. 5 Waveforms.

Transient immunity

$V_{CC} = 5\text{ V}$; $V_{CM} = 10\text{ V}_{PP}$; $R_L = 2,5\text{ k}\Omega$

Common mode transient immunity at logic low

$I_F = 10\text{ mA}$

CML min. $-1\text{ kV}/\mu\text{s}$

Common mode transient immunity at logic high

$I_F = 0$

CMH min. $1\text{ kV}/\mu\text{s}$

Logic high output current (note 1, see Fig. 6)

$V_{CC} = 5,5\text{ V}$; working voltage (d.c.) = $2,5\text{ kV}$;

$T_{amb} = 70\text{C}$

IOHW max. $100\ \mu\text{A}$

DEVELOPMENT DATA

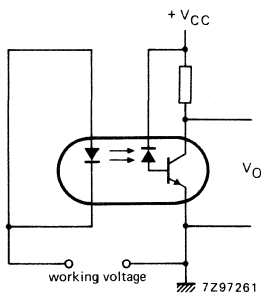

Fig. 6.

ISOLATION RELATED VALUES

External air gap (clearance)

input terminals to output terminals

L(I01) min. $7,2\text{ mm}$

External tracking path (creepage dist)

input terminals to output terminals

L(I02) min. $7,0\text{ mm}$

Tracking resistance (KB-value)

Notes

1. This parameter is the working collector-emitter leakage current measured when a high voltage is applied between the emitter and the short circuited diode leads.
2. Tested on a sample basis with a voltage of 3500 V (d.c.) or $2,5\text{ kV}$ (r.m.s.) for 1 minute between the shorted input (diode) leads and the shorted output (phototransistor) leads.

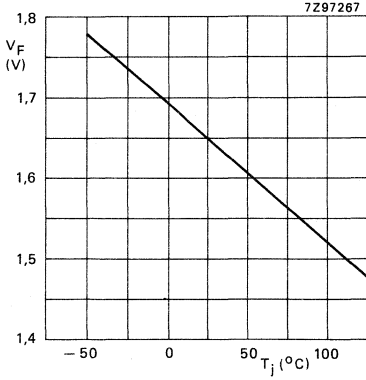

Fig. 7 $I_F = 10$ mA; typical values.

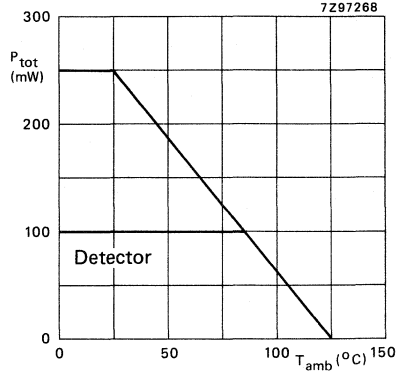

Fig. 8.

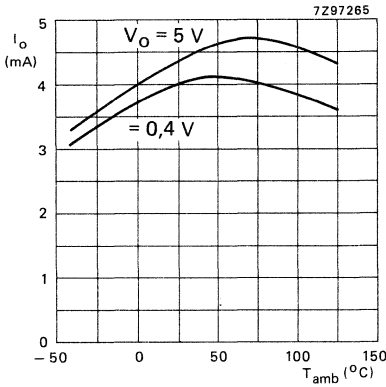

Fig. 9 $V_{CC} = 5$ V; $I_F = 10$ mA; typical values.

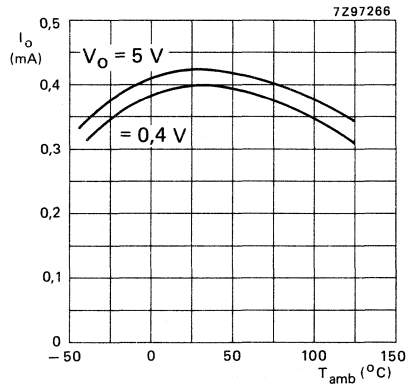

Fig. 10 $V_{CC} = 5$ V; $I_F = 2$ mA; typical values.

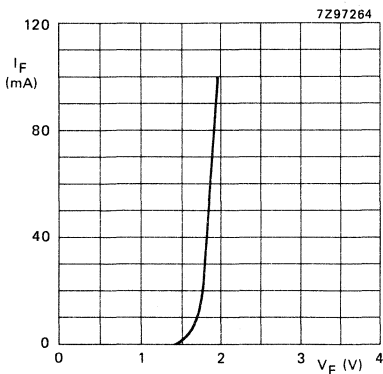

Fig. 11 $T_{amb} = 25$ °C; typical values.

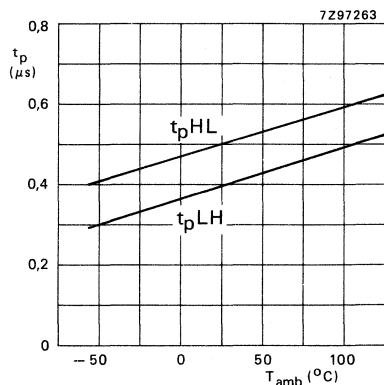

Fig. 12 $I_F = 10$ mA; $V_{CC} = 5$ V; $R_L = 2,5$ kΩ; typical values.

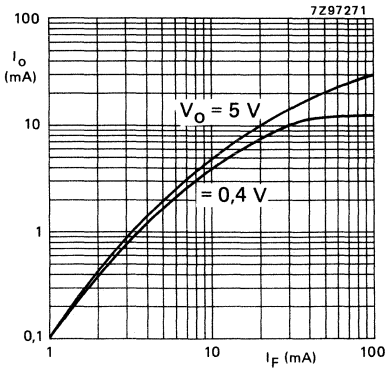

Fig. 13 $V_{CC} = 5V$; typical values.

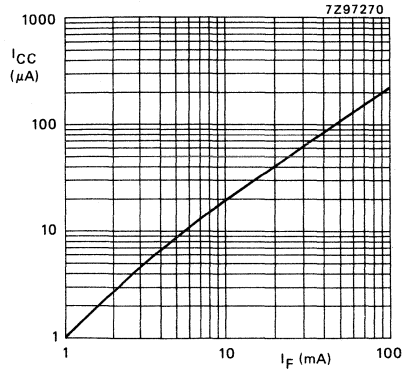

Fig. 14 $V_{CC} = 15V$; $I_O = 0$; typical values.

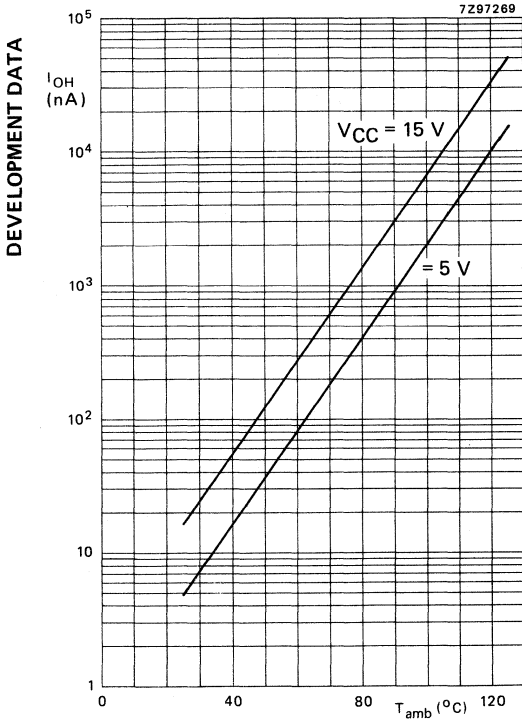

Fig. 15 Typical values.

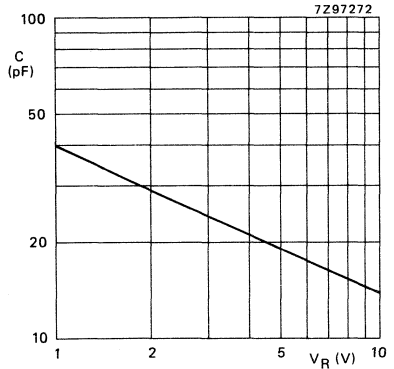

Fig. 16 $T_{amb} = 25^{\circ}C$; typical values.

Photodiode capacitance

HIGH-VOLTAGE OPTOCOUPLER

Optically coupled isolator consisting of an infrared emitting GaAs diode and a silicon n-p-n photo-transistor. The base is not accessible.

Features of this product:

- very high isolation voltage of 10 kV (d.c.).
- working voltage of 10 kV (d.c.).
- high common mode rejection 85 dB

QUICK REFERENCE DATA

Diode

Continuous reverse voltage	V_R	max.	5 V
Forward current d.c. (peak value); $t_p = 10 \mu\text{s}$; $\delta = 0,01$	I_F I_{FRM}	max.	50 mA 3 A
Total power dissipation up to $T_{amb} = 25 \text{ }^\circ\text{C}$	P_{tot}	max.	100 mW

Transistor

Collector-emitter voltage (open base)	V_{CEO}	max.	30 V
Total power dissipation up to $T_{amb} = 25 \text{ }^\circ\text{C}$	P_{tot}	max.	100 mW

Optocoupler

Output/input d.c. current transfer ratio (C.T.R.) $I_F = 10 \text{ mA}$; $V_{CE} = 0,4 \text{ V}$; ($I_B = 0$)	I_C/I_F	>	0,2
Collector cut-off current (dark) $V_{CC} = 10 \text{ V}$; working voltage (d.c.) = 10 kV diode: $I_F = 0$ (see also Fig. 4)	I_{CEW}	<	200 nA
Isolation voltage (d.c.)	V_{IORM}	min.	10 kV

MECHANICAL DATA

SOT-211 (see Fig. 1)

→ MECHANICAL DATA

Fig. 1 SOT-211.

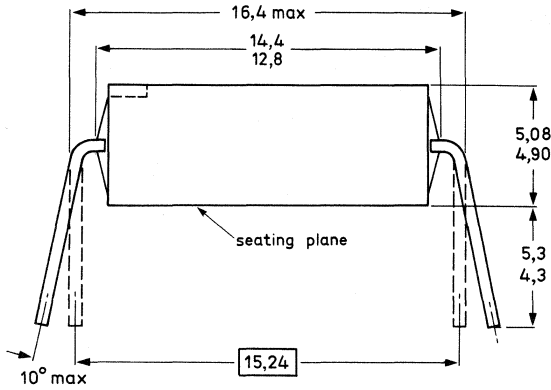

Dimensions in mm

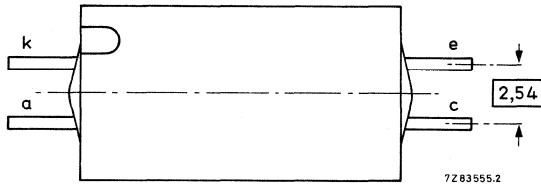
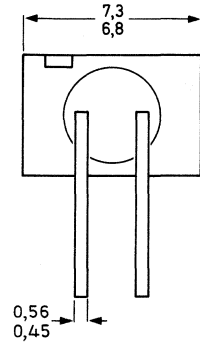

→ RATINGS

Limiting values in accordance with the Absolute Maximum System (IEC 134)

Diode

Continuous reverse voltage	V_R	max.	5 V
Forward current	I_F	max.	50 mA
d.c.	I_{FRM}	max.	3 A
(peak value); $t_p = 10 \mu s$; $\delta = 0,01$	P_{tot}	max.	100 mW
Total power dissipation up to $T_{amb} = 25 \text{ }^\circ\text{C}$			

Transistor

Collector-emitter voltage (open base)	V_{CEO}	max.	30 V
Emitter-collector voltage (open base)	V_{ECO}	max.	7 V
Collector current	I_C	max.	25 mA
d.c.	I_{CM}	max.	50 mA
peak value	P_{tot}	max.	100 mW
Total power dissipation up to $T_{amb} = 25 \text{ }^\circ\text{C}$			

Optocoupler

Storage temperature	T_{stg}	–55 to + 100 °C
Junction temperature	T_j	max. 100 °C
Lead soldering temperature up to the seating plane; $t_{slid} < 10$ s	T_{slid}	max. 260 °C

THERMAL RESISTANCE

From junction to ambient in free air diode transistor	$R_{th\ j-a}$	max.	750 K/W
	$R_{th\ j-a}$	max.	750 K/W
From junction to ambient, device mounted on a printed circuit board diode transistor	$R_{th\ j-a}$	max.	400 K/W
	$R_{th\ j-a}$	max.	400 K/W

CHARACTERISTICS

$T_j = 25$ °C unless otherwise specified

Diode

Forward voltage $I_F = 10$ mA	V_F	typ. <	1,15 V 1,3 V
Reverse current $V_R = 5$ V	I_R	<	100 μ A
Diode capacitance at $f = 1$ MHz $V_R = 0$	C_d	typ.	40 pF

Transistor

Collector cut-off current (dark) $V_{CE} = 10$ V	I_{CEO}	typ. <	2 nA 50 nA
Collector-emitter breakdown voltage open base; $I_C = 1$ mA	$V_{(BR)CEO}$	min.	30 V
Emitter-collector breakdown voltage open base; $I_E = 0,1$ mA	$V_{(BR)ECO}$	min.	7 V

Optocoupler ($I_B = 0$)*

Output/input d.c. current transfer ratio (C.T.R.) $I_F = 10$ mA; $V_{CE} = 0,4$ V	I_C/I_F	min. typ.	0,2 0,5
Collector-emitter saturation voltage $I_F = 10$ mA; $I_C = 2$ mA	V_{CEsat}	typ.	0,15 V
Isolation voltage, d.c. value (see note 1)	V_{IORM}	min.	10 kV

Note see next page.

* Where the phototransistor receives light from the diode the O (for open base) has been omitted from the symbols.

Capacitance between input and output

$I_F = 0; V = 0; f = 1 \text{ MHz}$

C_{io} typ. 0,15 pF

Insulation resistance between input and output

$\pm V_{IO} = 1 \text{ kV}$

$r_{IO} > 10^{11} \Omega$
 $12^{12} \Omega$

Common mode rejection (see Fig. 3)

$I_C = 2 \text{ mA}; f = 10 \text{ kHz}$

CMRR typ. 85 dB

Switching times (see Fig. 13)

$I_{Con} = 2 \text{ mA}; V_{CC} = 5 \text{ V}; R_L = 100 \Omega$

Turn-on time

t_{on} typ. 3 μs

Turn-off time

t_{off} typ. 3 μs

$I_{Con} = 2 \text{ mA}; V_{CC} = 5 \text{ V}; R_L = 1 \text{ k}\Omega$

Turn-on time

t_{on} typ. 12 μs

Turn-off time

t_{off} typ. 12,5 μs

Collector cut-off current (dark) see Fig. 2

$V_{CC} = 10 \text{ V}; \text{working voltage (d.c.)} = 10 \text{ kV}$

$I_{CEW} < 200 \text{ nA}^*$

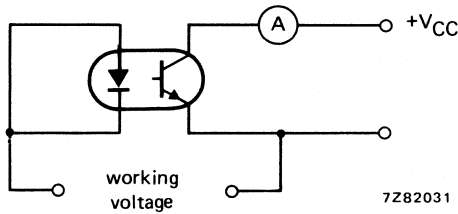

Fig. 2.

Notes

1. This parameter is tested with both input (diode) leads shorted together and both output (photo-transistor) leads shorted together at 10 kV (d.c.) for 1 min. Tested on sample basis.

2.
$$CMRR = \frac{V_o}{V_{CM}}$$

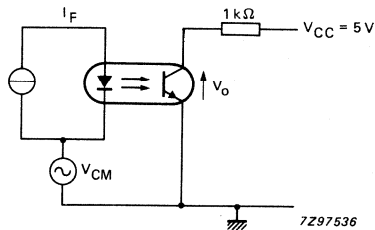

Fig. 3.

* As quality assurance (on a sample basis), these parameters are covered by a 1000 h reliability test.

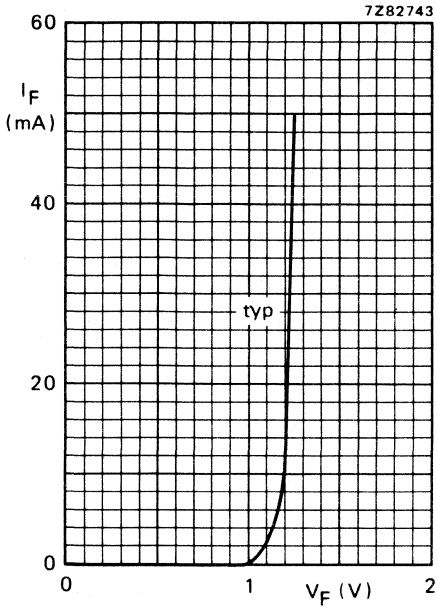

Fig. 4 $T_j = 25\text{ }^\circ\text{C}$.

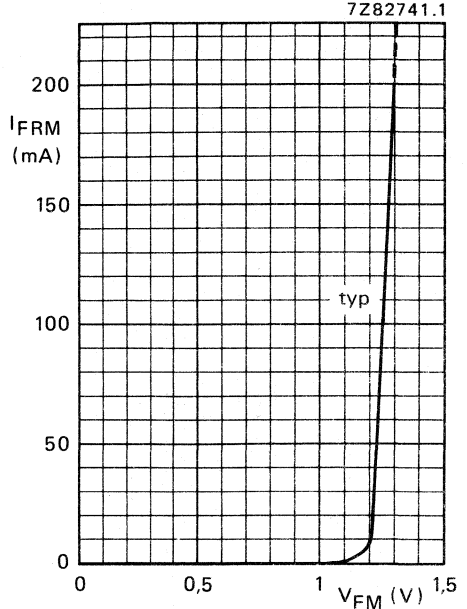

Fig. 5 $T_{amb} = 25\text{ }^\circ\text{C}$; $t_p = 10\text{ }\mu\text{s}$; $T = 1\text{ ms}$.

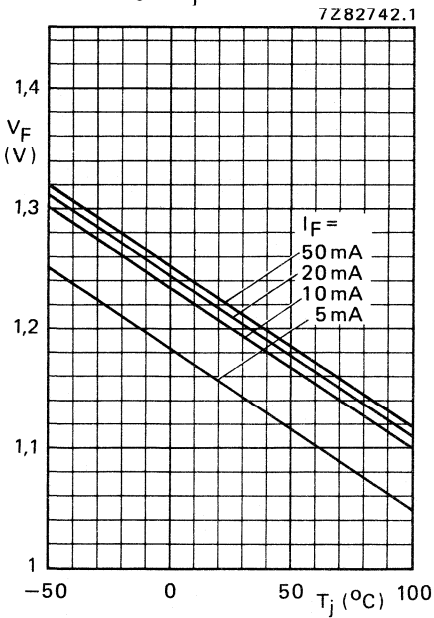

Fig. 6 Typical values.

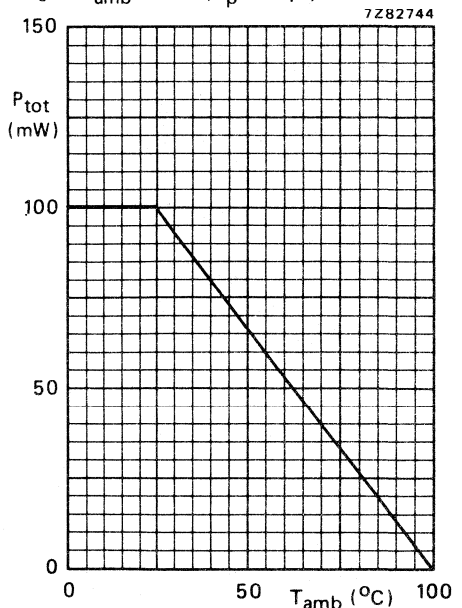

Fig. 7 Power derating curve for diode and transistor versus ambient temperature.

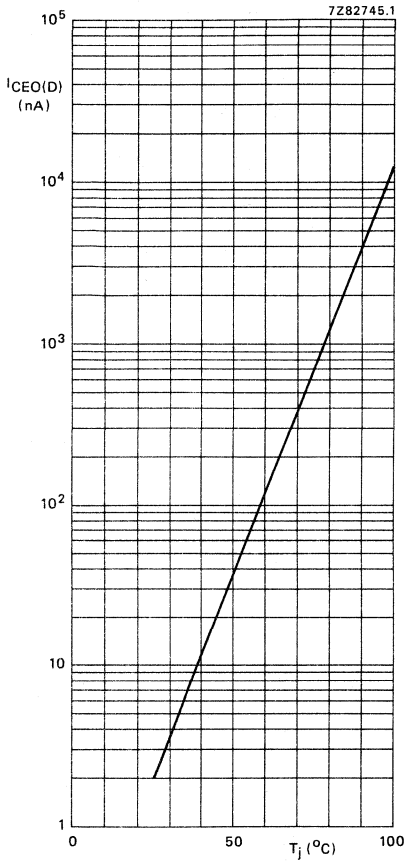

Fig. 8 Typical values.

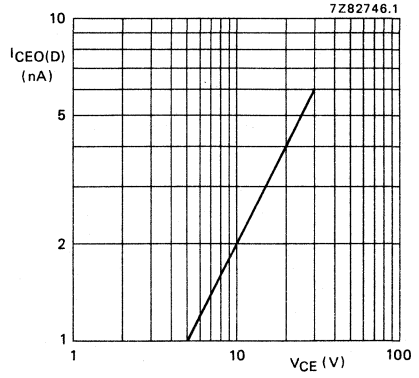

Fig. 9 Typical values.

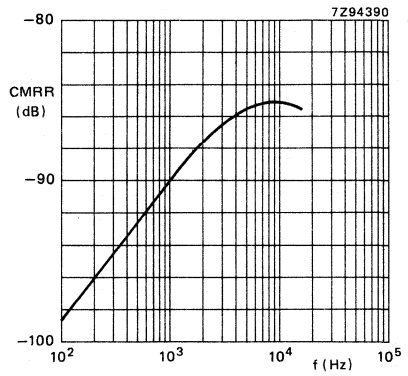

Fig. 10 Typical values.

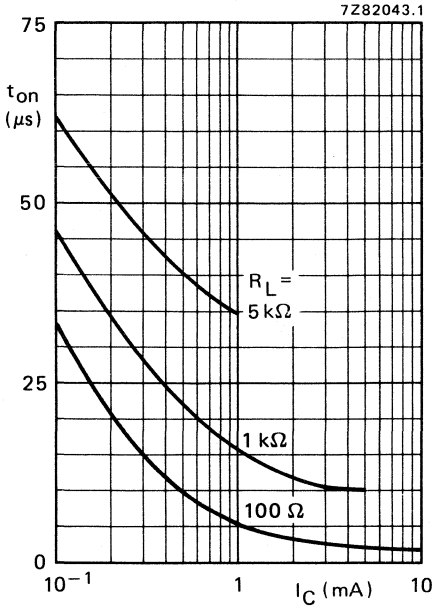

Fig. 11 $I_B = 0$; $V_{CC} = 5\text{ V}$; $T_{amb} = 25\text{ }^\circ\text{C}$; typical values. See also Fig. 13.

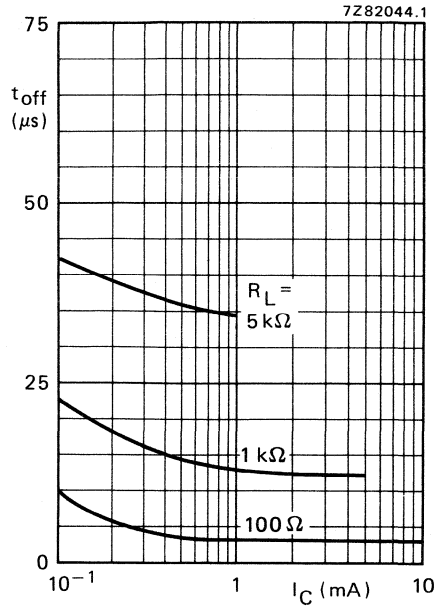

Fig. 12 $I_B = 0$; $V_{CC} = 5\text{ V}$; $T_{amb} = 25\text{ }^\circ\text{C}$; typical values. See also Fig. 13.

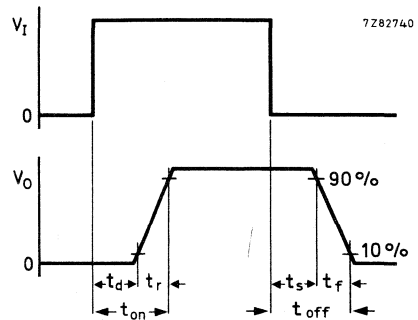
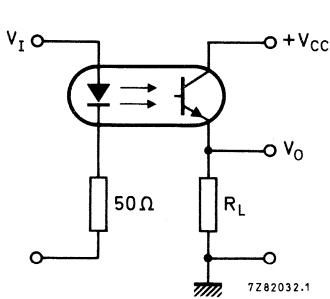

Fig. 13 Switching circuit and waveforms.

OPTOCOUPLERS

Optically coupled isolators consisting of an infrared emitting GaAs diode and a silicon n-p-n photo transistor with accessible base. Plastic envelopes. Suitable for TTL integrated circuits.

Features of these products:

- high output/input d.c. current transfer ratio;
- low saturation voltage;
- high isolation voltage of 3,12 kV (r.m.s.) and 4,4 kV (d.c.);
- working voltage 2,5 kV (d.c.).

QUICK REFERENCE DATA

Diode

Continuous reverse voltage	V_R	max.	5 V
Forward current d.c. (peak value); $t_p = 10 \mu s$; $\delta = 0,01$	I_F	max.	100 mA
	I_{FRM}	max.	3 A
Total power dissipation up to $T_{amb} = 25 \text{ }^\circ\text{C}$	P_{tot}	max.	200 mW

Transistor

Collector-emitter voltage (open base)	V_{CEO}	max.	30 V
Total power dissipation up to $T_{amb} = 25 \text{ }^\circ\text{C}$	P_{tot}	max.	200 mW

Optocoupler

Output/input d.c. current transfer ratio (C.T.R.) $I_F = 10 \text{ mA}$; $V_{CE} = 0,4 \text{ V}$; ($I_B = 0$)	CNX35 CNX39 CNX36	I_C/I_F	0,4 to 0,9 0,6 to 1,0 0,8 to 2,0
Collector cut-off current (dark) $V_{CC} = 10 \text{ V}$; working voltage (d.c.) = 2,5 kV diode: $I_F = 0$ (see also Fig. 2)		I_{CEW}	max. 200 nA
Isolation voltage (d.c.)		V_{IORM}	min. 4,4 kV

MECHANICAL DATA

SOT-90B (see Fig. 1).

MECHANICAL DATA

Fig. 1 SOT-90B.

Dimensions in mm

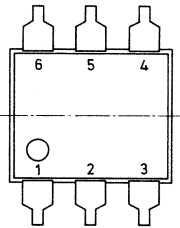
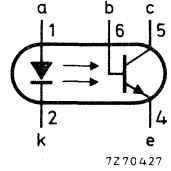
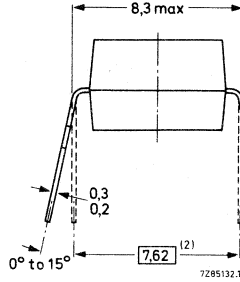
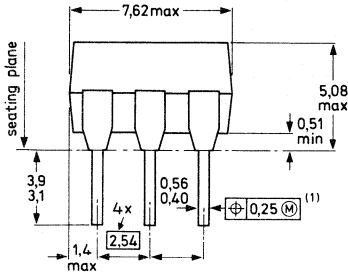

⊕ Positional accuracy.

Ⓜ Maximum Material Condition.

- (1) Centre-lines of all leads are within $\pm 0,125$ mm of the nominal position shown; in the worst case, the spacing between any two leads may deviate from nominal by 0,25 mm.
- (2) When the leads are parallel, the tips are in position for automatic insertion.

RATINGS

Limiting values in accordance with the Absolute Maximum System (IEC 134)

Diode

→ Continuous reverse voltage

V_R max. 5 V

Forward current

d.c.

I_F max. 100 mA

(peak value); $t_p = 10 \mu s$; $\delta = 0,01$

I_{FRM} max. 3 A

Total power dissipation up to $T_{amb} = 25 \text{ }^\circ\text{C}$

P_{tot} max. 200 mW

Transistor

Collector-emitter voltage (open base)

V_{CEO} max. 30 V

Collector-base voltage (open emitter)

V_{CB0} max. 70 V

Emitter-collector voltage (open base)

V_{ECO} max. 7 V

Collector current (d.c.)

I_C max. 100 mA

Total power dissipation up to $T_{amb} = 25 \text{ }^\circ\text{C}$

P_{tot} max. 200 mW

Optocoupler

Storage temperature	T_{stg}	-55 to +150 °C	←
Operating junction temperature	T_j	max. 125 °C	
Lead soldering temperature up to the seating plane; $t_{sld} < 10$ s	T_{sld}	max. 260 °C	

THERMAL RESISTANCE

From junction to ambient in free air diode	$R_{th\ j-a}$	=	500 K/W
transistor	$R_{th\ j-a}$	=	500 K/W
From junction to ambient, device mounted on a printed-circuit board diode	$R_{th\ j-a}$	=	400 K/W
transistor	$R_{th\ j-a}$	=	400 K/W

ISOLATION RELATED VALUES

External air gap (clearance) input terminals to output terminals	$L(I01)$	min.	7,2 mm
External tracking path (creepage dist) input terminals to output terminals	$L(I02)$	min.	7,0 mm
Tracking resistance (KB-value)			KB-100/A

CHARACTERISTICS

$T_j = 25$ °C unless otherwise specified

Diode

Forward voltage $I_F = 10$ mA	V_F	typ. max.	1,15 V 1,5 V
Reverse current $V_R = 5$ V	I_R	max.	10 μ A ←

Transistor ($I_F = 0$)

Collector cut-off current (dark) $V_{CE} = 10$ V	I_{CEO}	typ. max.	2 nA 50 nA
$V_{CE} = 10$ V; $T_{amb} = 70$ °C	I_{CEO}	max.	10 μ A
$V_{CB} = 10$ V	I_{CBO}	max.	20 nA
Collector-emitter breakdown voltage at $I_C = 1$ mA	$V(BR)_{CEO}$	min.	30 V
Collector-base breakdown voltage at $I_C = 0,1$ mA	$V(BR)_{CBO}$	min.	70 V
Emitter-collector breakdown voltage at $I_E = 0,1$ mA	$V(BR)_{ECO}$	min.	7 V

Optocoupler ($I_B = 0$)*

Output/input d.c. current transfer ratio (C.T.R.) $I_F = 10$ mA; $V_{CE} = 0,4$ V	CNX35	I_C/I_F	0,4 to 0,9	←
	CNX39	I_C/I_F	0,6 to 1,0	
	CNX36	I_C/I_F	0,8 to 2,0	

* Where the phototransistor receives light from the diode the O (for open base) has been omitted from the symbols.

Output/input d.c. current transfer ratio (C.T.R.)

$I_F = 10 \text{ mA}; V_{CE} = 5 \text{ V}$ I_C/I_F typ. 1,5

Collector-emitter saturation voltage

$I_F = 10 \text{ mA}; I_C = 2 \text{ mA}$ **CNX35** V_{CEsat} max. 0,4

CNX39 typ. 0,15

$I_F = 10 \text{ mA}; I_C = 4 \text{ mA}$ **CNX36** V_{CEsat} max. 0,4

typ. 0,19

Isolation voltage **

V_{IORM} min. 4,4 kV (d.c.)
3,12 kV (r.m.s.)

Collector cut-off current (light) at $T_{amb} = 0 \text{ }^\circ\text{C}$ to $70 \text{ }^\circ\text{C}$

$V_F = 0,8 \text{ V}; V_{CE} = 15 \text{ V}$ $I_{CE(L)}$ max. 15 μA

$I_F = 2 \text{ mA}; V_{CE} = 0,4 \text{ V}$ $I_{CE(L)}$ min. 150 μA

Collector capacitance at $f = 1 \text{ MHz}$

$I_E = I_e = 0; V_{CB} = 10 \text{ V}$ C_{bc} typ. 4,5 pF

Capacitance between input and output

$I_F = 0; V = 0; f = 1 \text{ MHz}$ C_{io} typ. 0,6 pF

Insulation resistance between input and output

$\pm V_{IO} = 1 \text{ kV}$ r_{IO} min. $10^{10} \Omega$
typ. $10^{12} \Omega$

Switching times (see Figs 2 and 3)

$I_{Con} = 2 \text{ mA}; V_{CC} = 5 \text{ V}; R_L = 100 \Omega$

Turn-on time t_{on} typ. 3 5,5 8 μs

Turn-off time t_{off} typ. 3 4 6 μs

$I_{Con} = 2 \text{ mA}; V_{CC} = 5 \text{ V}; R_L = 1 \text{ k}\Omega$

Turn-on time t_{on} typ. 12 14 20 μs

Turn-off time t_{off} typ. 12 12 18 μs

Collector cut-off current (dark) see Fig. 4

$V_{CC} = 10 \text{ V};$ working voltage (d.c.) = 2,5 kV I_{CEW} max. 200 nA*

$V_{CC} = 10 \text{ V};$ working voltage (d.c.) = 2,5 kV; $T_j = 70 \text{ }^\circ\text{C}$ I_{CEW} max. 100 μA *

* As quality assurance (on a sample basis), these parameters are covered by a 1000 h reliability test.

** Tested on a sample basis with a voltage of 4400 Vdc for 1 minute between the shorted input (diode) leads and the shorted output (phototransistor) leads.

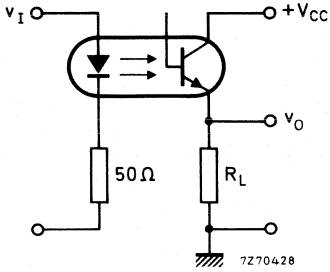

Fig. 2 Switching circuit.

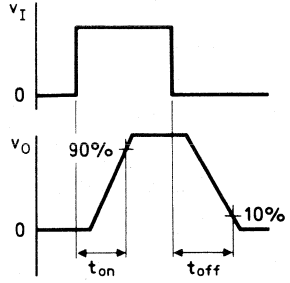

Fig. 3 Waveforms.

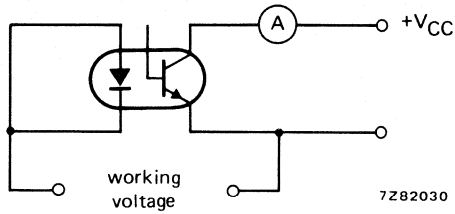

Fig. 4.

7Z82646

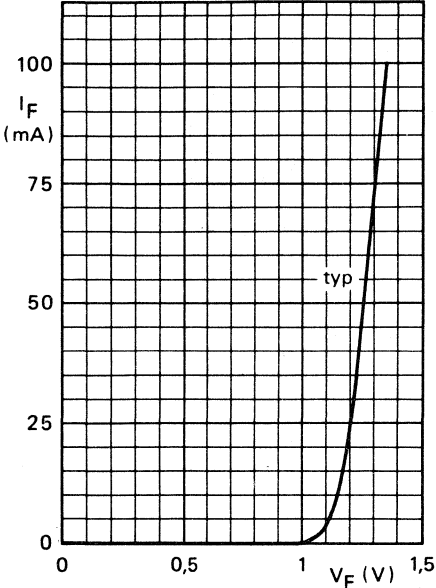

Fig. 5 $T_{amb} = 25\text{ °C}$.

7Z82647

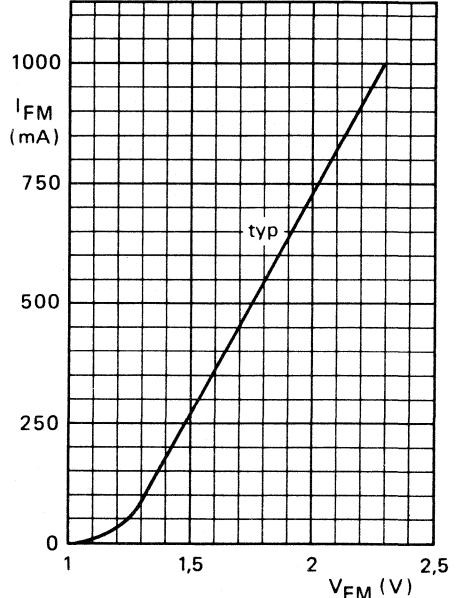

Fig. 6 $T_{amb} = 25\text{ °C}$; $t_p = 10\text{ }\mu\text{s}$; $T = 1\text{ ms}$.

7Z82648

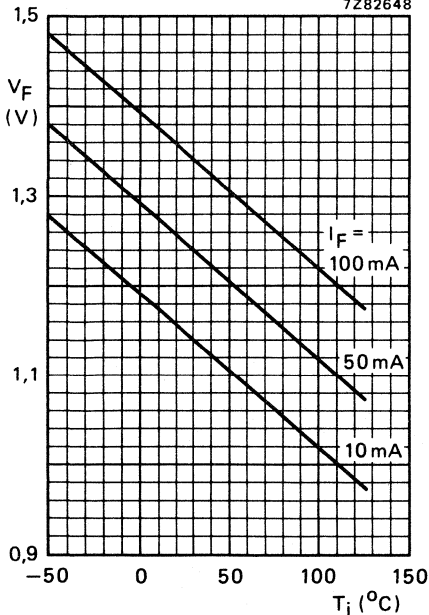

Fig. 7 Typical values.

7Z82649

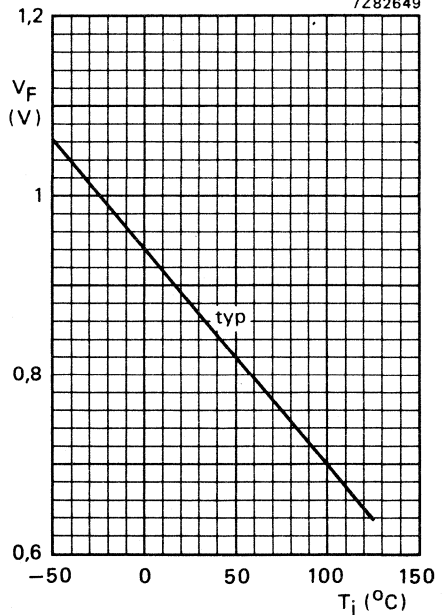

Fig. 8 $I_F = 50\text{ }\mu\text{A}$.

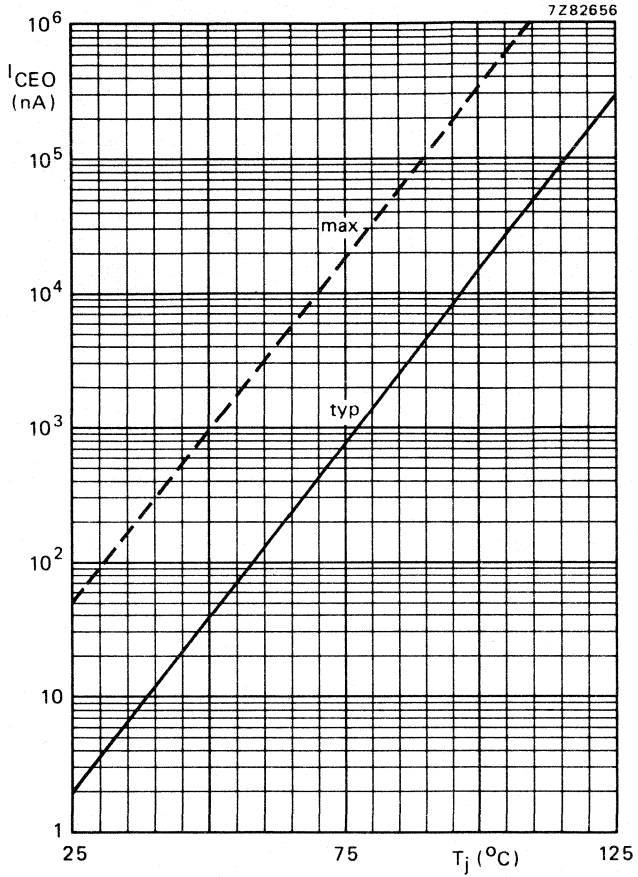

Fig. 9 $I_F = 0$; $V_{CE} = 10$ V.

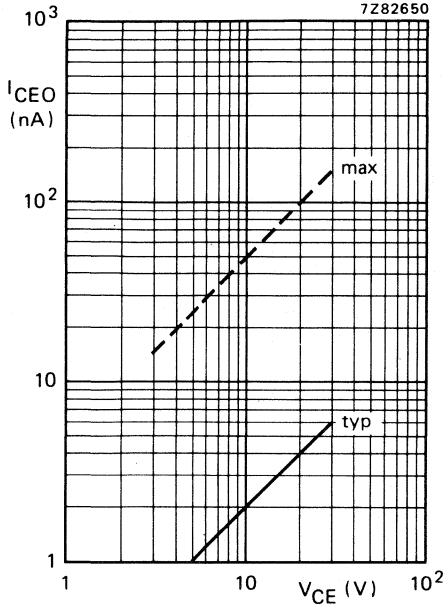

Fig. 10 $I_F = 0$; $T_j = 25^\circ\text{C}$.

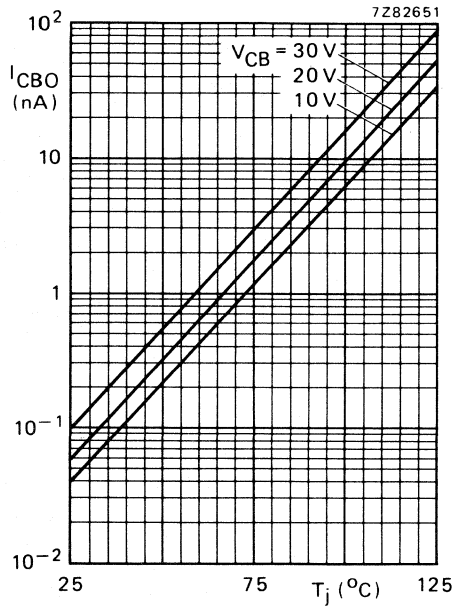

Fig. 11 Typical values.

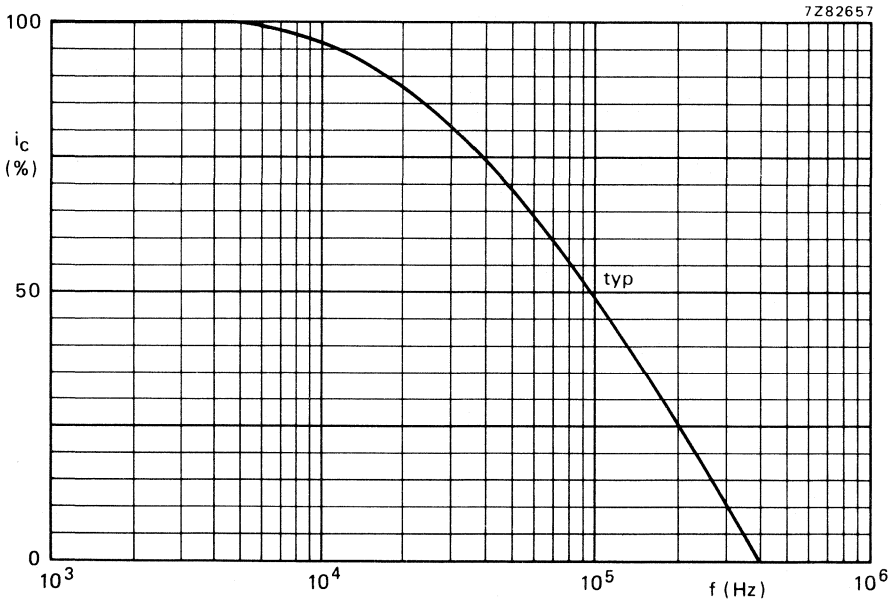

Fig. 12 $I_B = 0$; $I_C = 2\text{ mA}$; $V_{CC} = 5\text{ V}$; $R_L = 1\text{ k}\Omega$; $T_{amb} = 25^\circ\text{C}$.

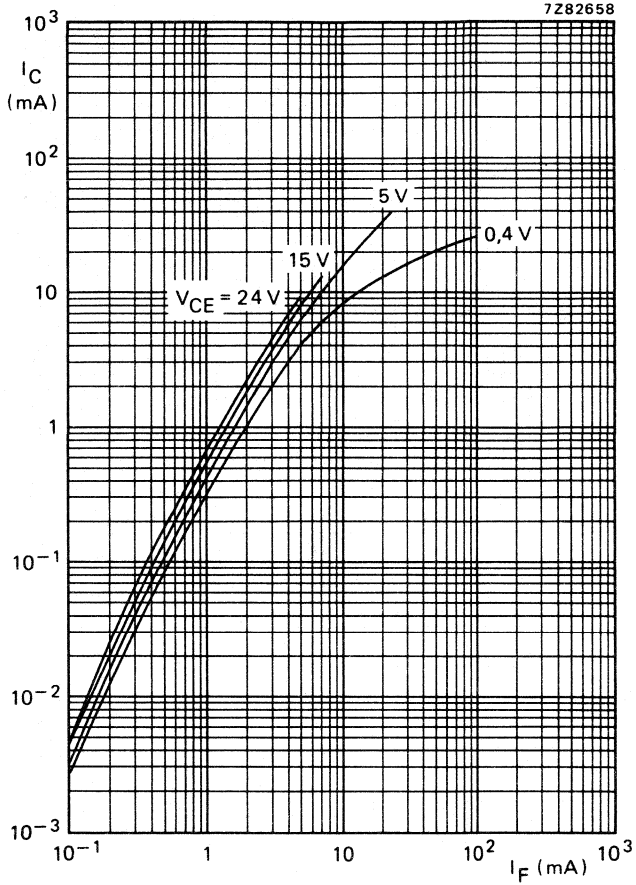

Fig. 13 $T_{amb} = 25$ °C, typical values.

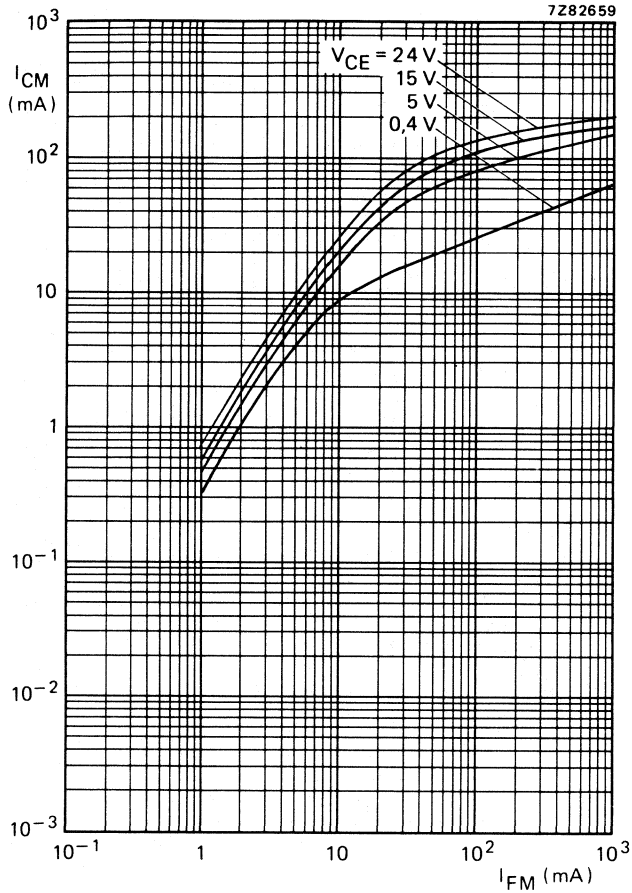

Fig. 14 $T_{amb} = 25^{\circ}\text{C}$; $t_p = 10 \mu\text{s}$; $T = 1 \text{ ms}$; typical values.

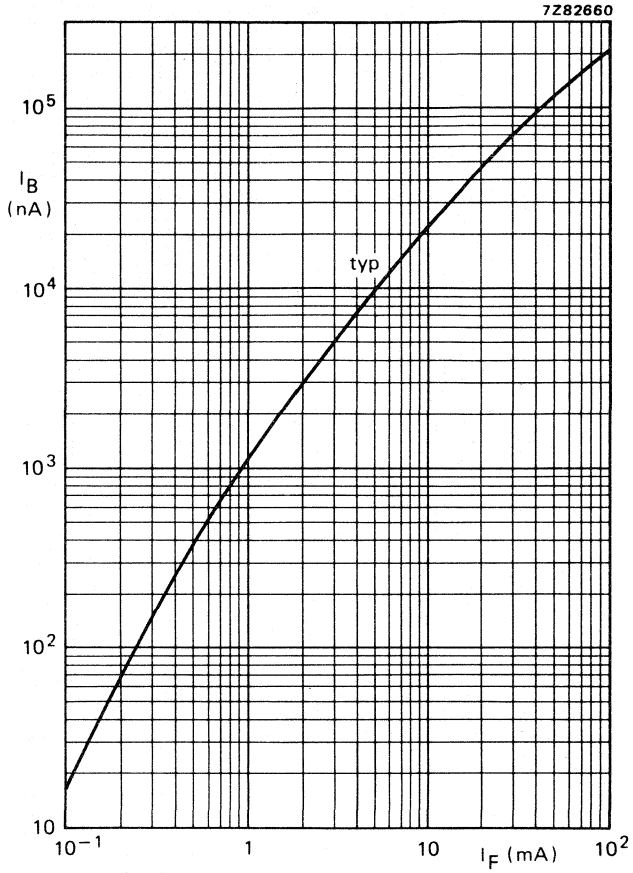

Fig. 15 $V_{CB} = 5 \text{ V}$; $T_{amb} = 25 \text{ }^\circ\text{C}$.

7Z82661

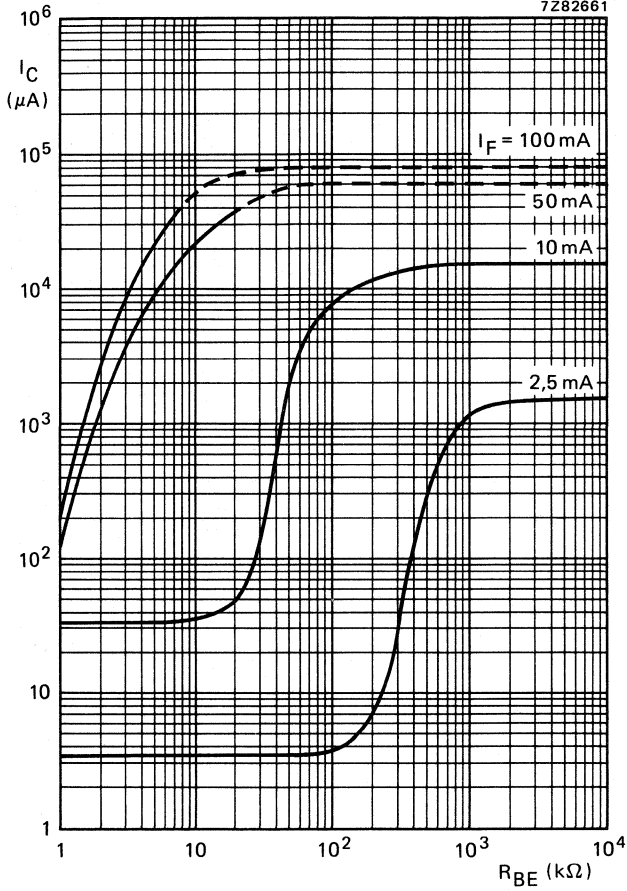

Fig. 16 $I_B = 0$; $V_{CE} = 5 \text{ V}$; $T_{\text{amb}} = 25 \text{ }^\circ\text{C}$; typical values.

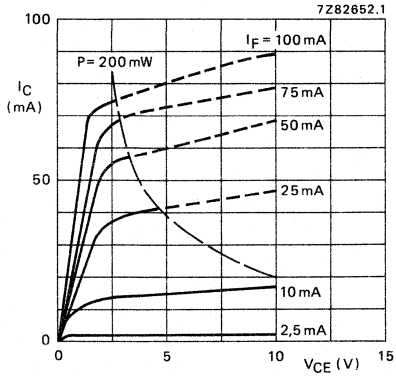

Fig. 17 $T_{amb} = 25 \text{ }^\circ\text{C}$; typical values.

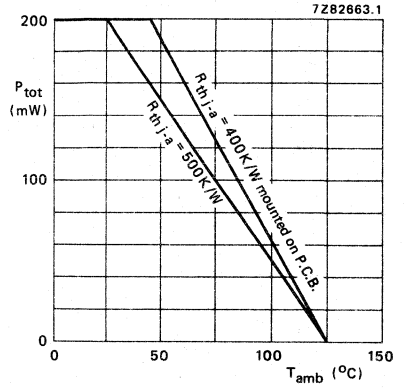

Fig. 18.

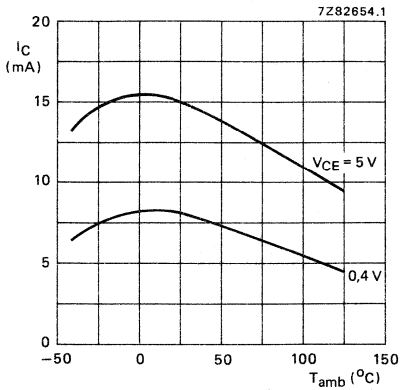

Fig. 19 $I_F = 10 \text{ mA}$; typical values.

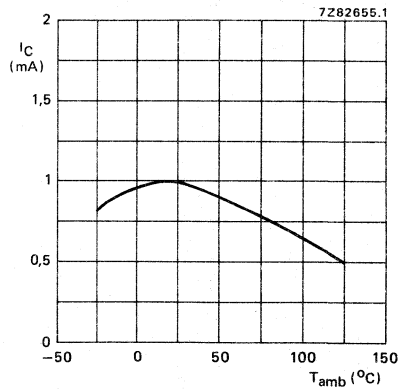

Fig. 20 $I_F = 2 \text{ mA}$; $V_{CE} = 0,4 \text{ V}$; typical values.

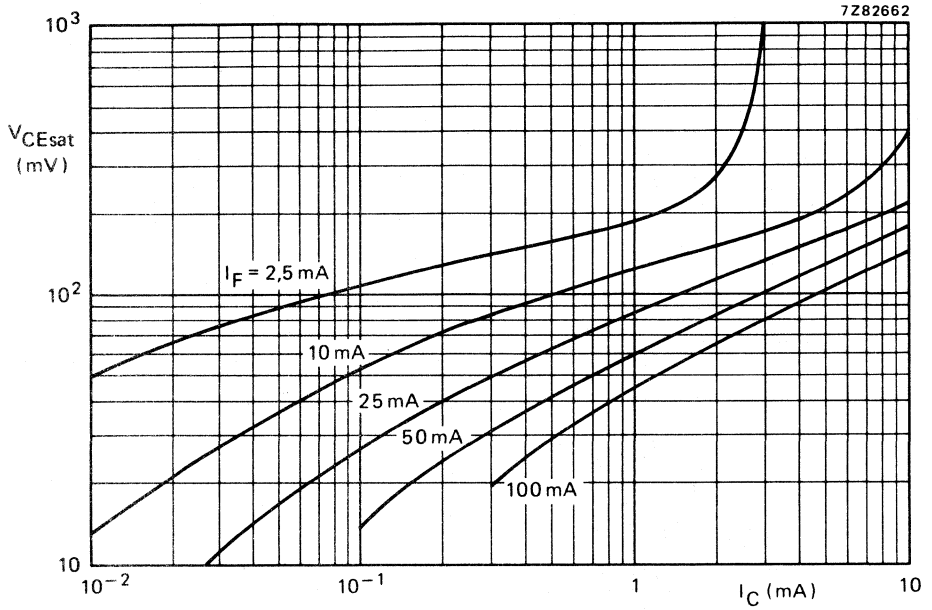

Fig. 21 $I_B = 0$; $T_{amb} = 25^\circ C$; typical values.

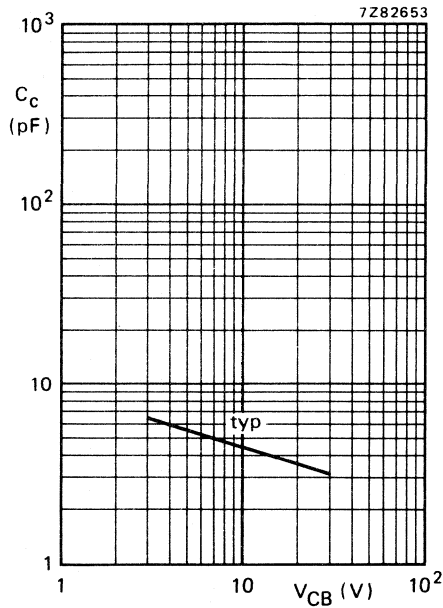

Fig. 22 $f = 1$ MHz; $T_{amb} = 25^\circ C$.

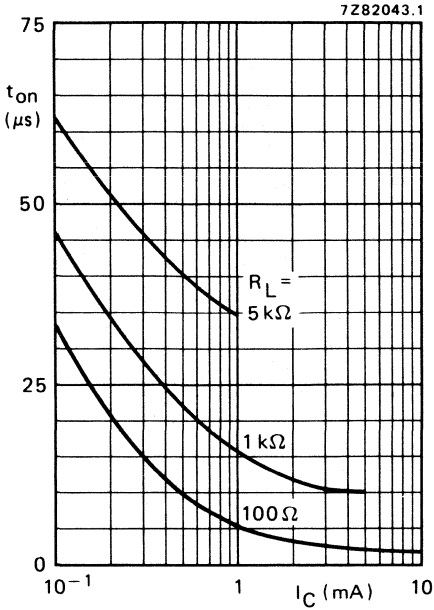

Fig. 23 $I_B = 0$; $V_{CC} = 5\text{ V}$; $T_{amb} = 25\text{ }^\circ\text{C}$; typical values. (See also Fig. 25) CNX35.

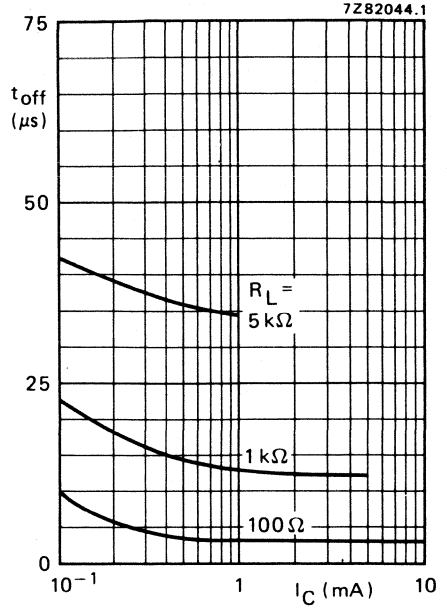

Fig. 24 $I_B = 0$; $V_{CC} = 5\text{ V}$; $T_{amb} = 25\text{ }^\circ\text{C}$; typical values. (See also Fig. 25) CNX35.

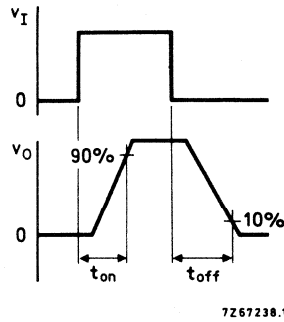
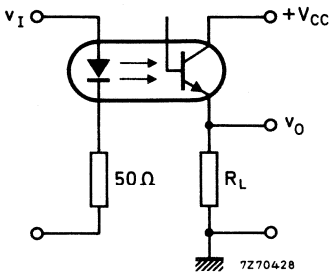

Fig. 25 Switching circuit and waveforms.

OPTOCOUPLERS

Optically coupled isolators consisting of an infrared emitting GaAs diode and a silicon n-p-n photo transistor with accessible base. Plastic envelopes. Suitable for TTL integrated circuits.

Features of these products:

- high output/input d.c. current transfer ratio;
- low saturation voltage;
- high isolation voltage of 3,12 kV (r.m.s.) and 4,4 kV (d.c.);
- working voltage 2,5 kV (d.c.)

UL — Covered under UL component recognition FILE E90700

VDE — Approved according to VDE 0883/6.83

Complied for reinforced isolation at 250 VAC with:

DIN 57 804/VDE 0804/1.83 (isolation group C)
 DIN IEC 65/VDE 0860/8.81

QUICK REFERENCE DATA

Diode

Continuous reverse voltage	V_R	max.	5 V	←
Forward current	I_F	max.	100 mA	
d.c.	I_{FRM}	max.	3 A	
(peak value); $t_p = 10 \mu s$; $\delta = 0,01$				
Total power dissipation up to $T_{amb} = 25 \text{ }^\circ\text{C}$	P_{tot}	max.	200 mW	

Transistor

Collector-emitter voltage (open base)	V_{CEO}	max.	30 V	
Total power dissipation up to $T_{amb} = 25 \text{ }^\circ\text{C}$	P_{tot}	max.	200 mW	

Optocoupler

Output/input d.c. current transfer ratio (C.T.R.)	CNX35U		0,4 to 0,9	←
$I_F = 10 \text{ mA}$; $V_{CE} = 0,4 \text{ V}$; ($I_B = 0$)	CNX39U	I_C/I_F	0,6 to 1,0	
	CNX36U		0,8 to 2,0	
Collector cut-off current (dark)		I_{CEW}	max.	200 nA
$V_{CC} = 10 \text{ V}$; working voltage (d.c.) = 2,5 kV		V_{IORM}	min.	4,4 kV
diode: $I_F = 0$ (see also Fig. 2)				
Isolation voltage (d.c.)				

MECHANICAL DATA

SOT-90B (see Fig. 1).

MECHANICAL DATA

Dimensions in mm

Fig. 1 SOT-90B.

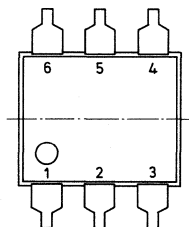
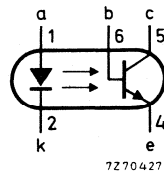
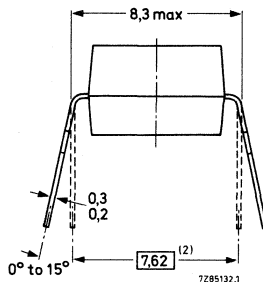
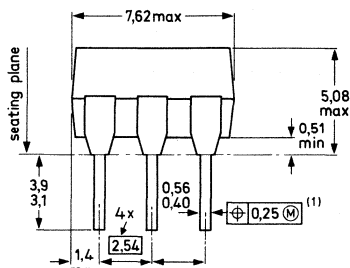

⊕ Positional accuracy.

Ⓜ Maximum Material Condition.

- (1) Centre-lines of all leads are within $\pm 0,125$ mm of the nominal position shown; in the worst case, the spacing between any two leads may deviate from nominal by 0,25 mm.
- (2) When the leads are parallel, the tips are in position for automatic insertion.

RATINGS

Limiting values in accordance with the Absolute Maximum System (IEC 134)

Diode

Continuous reverse voltage	V_R	max.	5 V
Forward current d.c. (peak value); $t_p = 10 \mu s$; $\delta = 0,01$	I_F	max.	100 mA
	I_{FRM}	max.	3 A
Total power dissipation up to $T_{amb} = 25^\circ C$	P_{tot}	max.	200 mW

Transistor

Collector-emitter voltage (open base)	V_{CEO}	max.	30 V
Collector-base voltage (open emitter)	V_{CBO}	max.	70 V
Emitter-collector voltage (open base)	V_{ECO}	max.	7 V
Collector current (d.c.)	I_C	max.	100 mA
Total power dissipation up to $T_{amb} = 25^\circ C$	P_{tot}	max.	200 mW

Optocoupler

Storage temperature	T_{stg}	-55 to +150 °C	←
Operating junction temperature	T_j	max. 125 °C	
Lead soldering temperature up to the seating plane; $t_{sld} < 10$ s	T_{sld}	max. 260 °C	

THERMAL RESISTANCE

From junction to ambient in free air diode	$R_{th\ j-a}$	=	500 K/W
transistor	$R_{th\ j-a}$	=	500 K/W
From junction to ambient, device mounted on a printed-circuit board diode	$R_{th\ j-a}$	=	400 K/W
transistor	$R_{th\ j-a}$	=	400 K/W

ISOLATION RELATED VALUES

External air gap (clearance) input terminals to output terminals	L(IO1)	min.	7,2 mm
External tracking path (creepage dist) input terminals to output terminals	L(IO2)	min.	7,0 mm
Tracking resistance (KB-value)			KB-100/A

CHARACTERISTICS

$T_j = 25$ °C unless otherwise specified

Diode

Forward voltage $I_F = 10$ mA	V_F	typ. max.	1,15 V 1,5 V
Reverse current $V_R = 5$ V	I_R	max.	10 μ A ←

Transistor ($I_F = 0$)

Collector cut-off current (dark) $V_{CE} = 10$ V	I_{CEO}	typ. max.	2 nA 50 nA
$V_{CE} = 10$ V; $T_{amb} = 70$ °C	I_{CEO}	max.	10 μ A
$V_{CB} = 10$ V	I_{CBO}	max.	20 nA
Collector-emitter breakdown voltage at $I_C = 1$ mA	$V_{(BR)CEO}$	min.	30 V
Collector-base breakdown voltage at $I_C = 0,1$ mA	$V_{(BR)CBO}$	min.	70 V
Emitter-collector breakdown voltage at $I_E = 0,1$ mA	$V_{(BR)ECO}$	min.	7 V

Optocoupler ($I_B = 0$)*

Output/input d.c. current transfer ratio (C.T.R.) $I_F = 10$ mA; $V_{CE} = 0,4$ V	CNX35U	I_C/I_F	0,4 to 0,9	←
	CNX39U	I_C/I_F	0,6 to 1,0	
	CNX36U	I_C/I_F	0,8 to 2,0	

* Where the phototransistor receives light from the diode the O (for open base) has been omitted from the symbols.

Output/input d.c. current transfer ratio (C.T.R.)

$I_F = 10 \text{ mA}; V_{CE} = 5 \text{ V}$

I_C/I_F typ. 1,5

Collector-emitter saturation voltage

$I_F = 10 \text{ mA}; I_C = 2 \text{ mA}$

CNX35U

V_{CEsat} max. 0,4
typ. 0,15

CNX39U

$I_F = 10 \text{ mA}; I_C = 4 \text{ mA}$

CNX36U

V_{CEsat} max. 0,4
typ. 0,19

Isolation voltage, d.c. value**

V_{IORM} min. 4,4 kV

Isolation voltage, r.m.s. value

V_{IORM} min. 3,12 kV

Collector cut-off current (light) at $T_{amb} = 0 \text{ }^\circ\text{C}$ to $70 \text{ }^\circ\text{C}$

$V_F = 0,8 \text{ V}; V_{CE} = 15 \text{ V}$

$I_{CE(L)}$ max. 15 μA

$I_F = 2 \text{ mA}; V_{CE} = 0,4 \text{ V}$

$I_{CE(L)}$ min. 150 μA

Collector capacitance at $f = 1 \text{ MHz}$

$I_E = I_e = 0; V_{CB} = 10 \text{ V}$

C_{bc} typ. 4,5 pF

Capacitance between input and output

$I_F = 0; V = 0; f = 1 \text{ MHz}$

C_{io} typ. 0,6 pF

Insulation resistance between input and output

$\pm V_{IO} = 1 \text{ kV}$

r_{IO} min. $10^{10} \Omega$
typ. $10^{12} \Omega$

Switching times (see Figs 2 and 3)

$I_{Con} = 2 \text{ mA}; V_{CC} = 5 \text{ V}; R_L = 100 \Omega$

CNX35U **CNX39U** **CNX36U**

Turn-on time

t_{on} typ. 3 5,5 8 μs

Turn-off time

t_{off} typ. 3 4 6 μs

$I_{Con} = 2 \text{ mA}; V_{CC} = 5 \text{ V}; R_L = 1 \text{ k}\Omega$

Turn-on time

t_{on} typ. 12 14 20 μs

Turn-off time

t_{off} typ. 12 12 18 μs

Collector cut-off current (dark) see Fig. 4

$V_{CC} = 10 \text{ V};$ working voltage (d.c.) = 2,5 kV

I_{CEW} max. 200 nA*

$V_{CC} = 10 \text{ V};$ working voltage (d.c.) = 2,5 kV; $T_j = 70 \text{ }^\circ\text{C}$

I_{CEW} max. 100 μA *

* As quality assurance (on a sample basis), these parameters are covered by a 1000 h reliability test.

** Every single product is tested by applying an isolation test voltage of 3750 Vac (rms) for 2 seconds between the shorted input (diode) leads and the shorted output (phototransistor) leads.

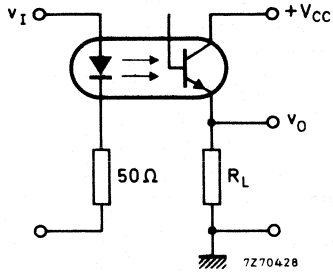

Fig. 2 Switching circuit.

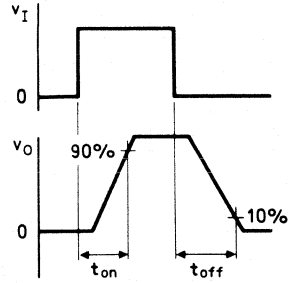

Fig. 3 Waveforms.

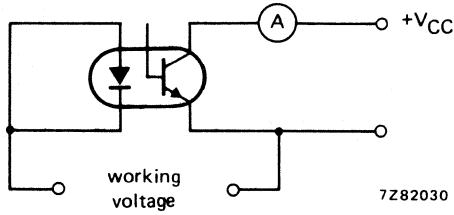

Fig. 4.

7Z82646

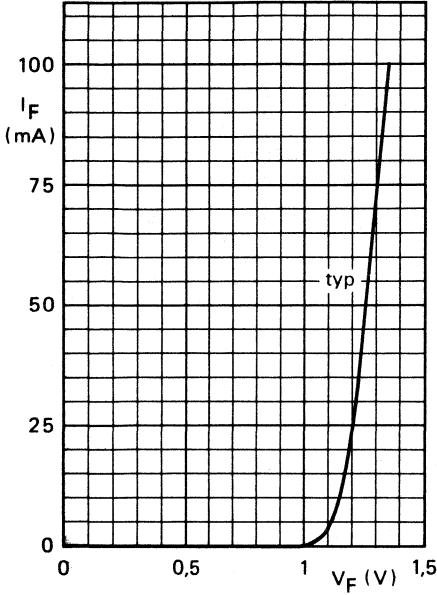

Fig. 5 $T_{amb} = 25\text{ }^{\circ}\text{C}$.

7Z82647

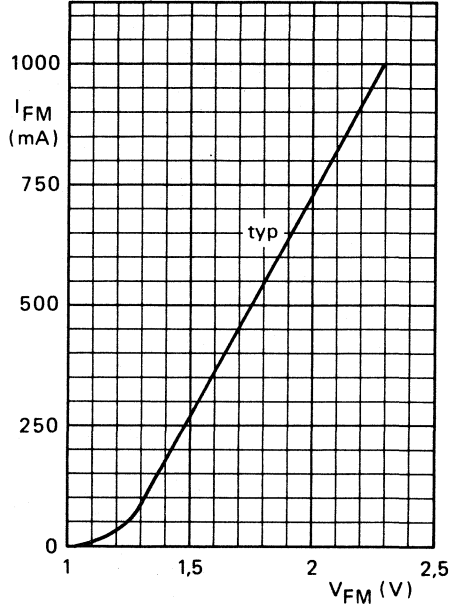

Fig. 6 $T_{amb} = 25\text{ }^{\circ}\text{C}$; $t_p = 10\text{ }\mu\text{s}$; $T = 1\text{ ms}$.

7Z82648

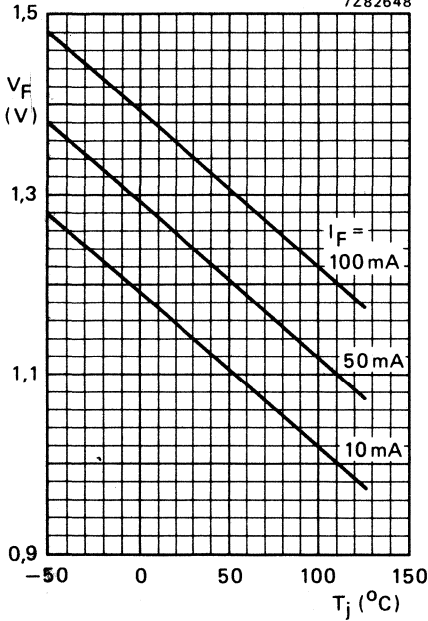

Fig. 7 Typical values.

7Z82649

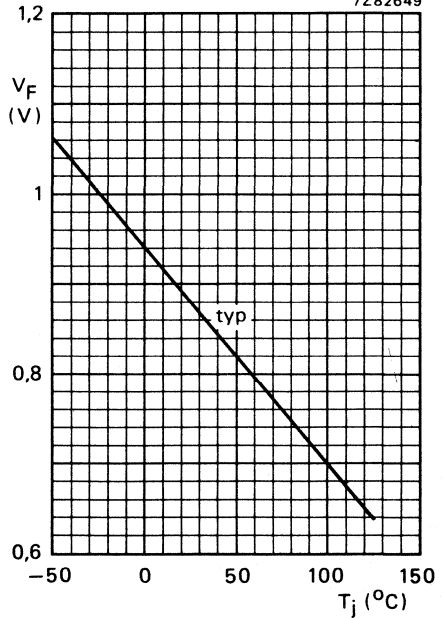

Fig. 8 $I_F = 50\text{ }\mu\text{A}$.

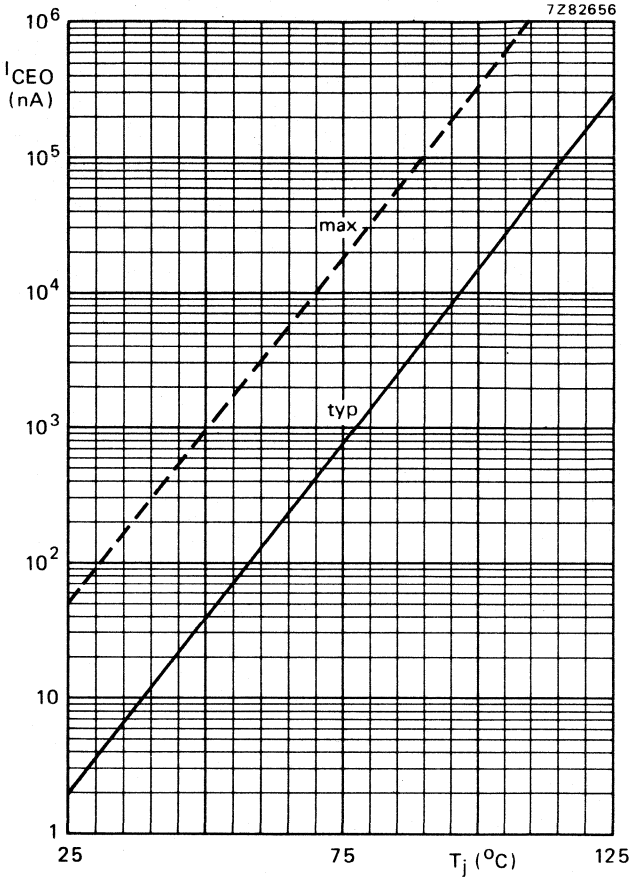

Fig. 9 $I_F = 0$; $V_{CE} = 10$ V.

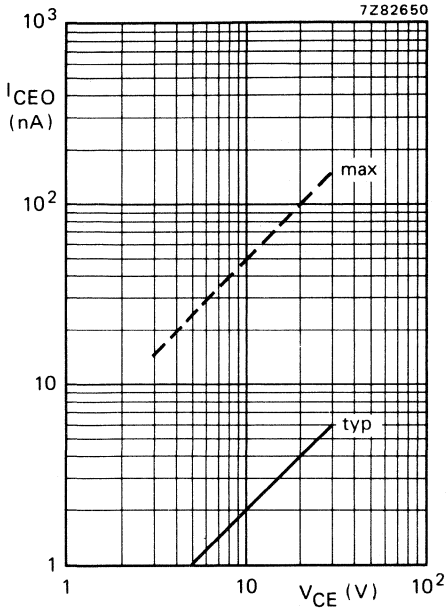

Fig. 10 $I_F = 0$; $T_j = 25^\circ\text{C}$.

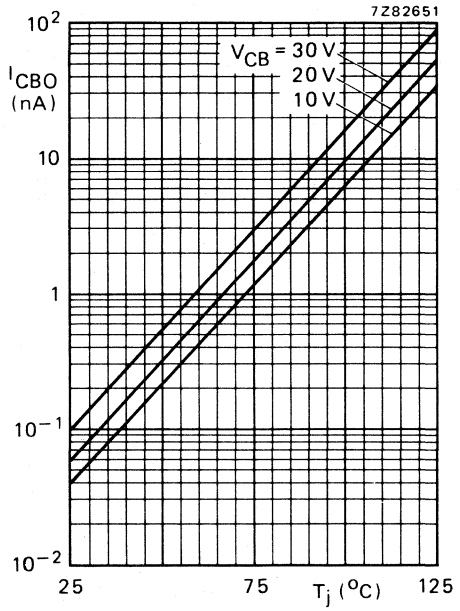

Fig. 11 Typical values.

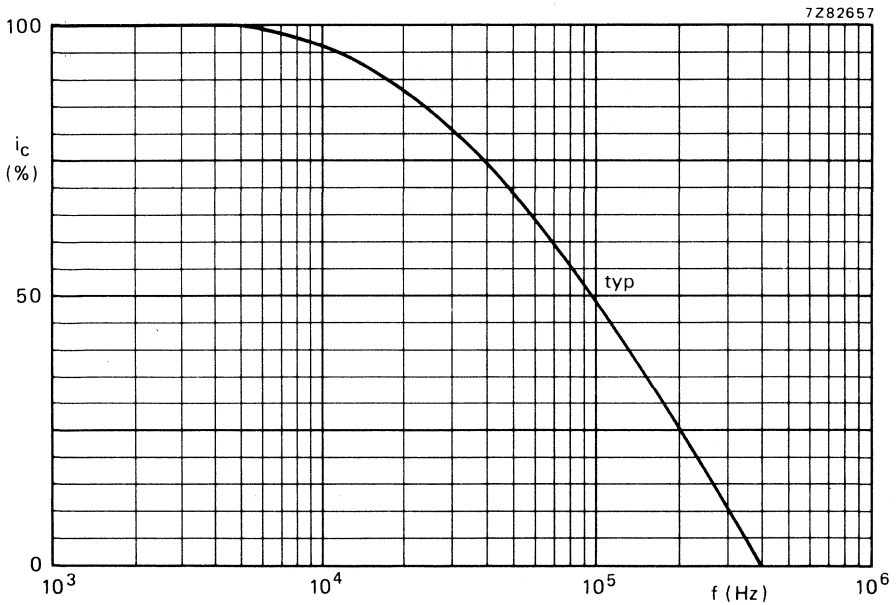

Fig. 12 $I_B = 0$; $I_C = 2\text{ mA}$; $V_{CC} = 5\text{ V}$; $R_L = 1\text{ k}\Omega$; $T_{\text{amb}} = 25^\circ\text{C}$.

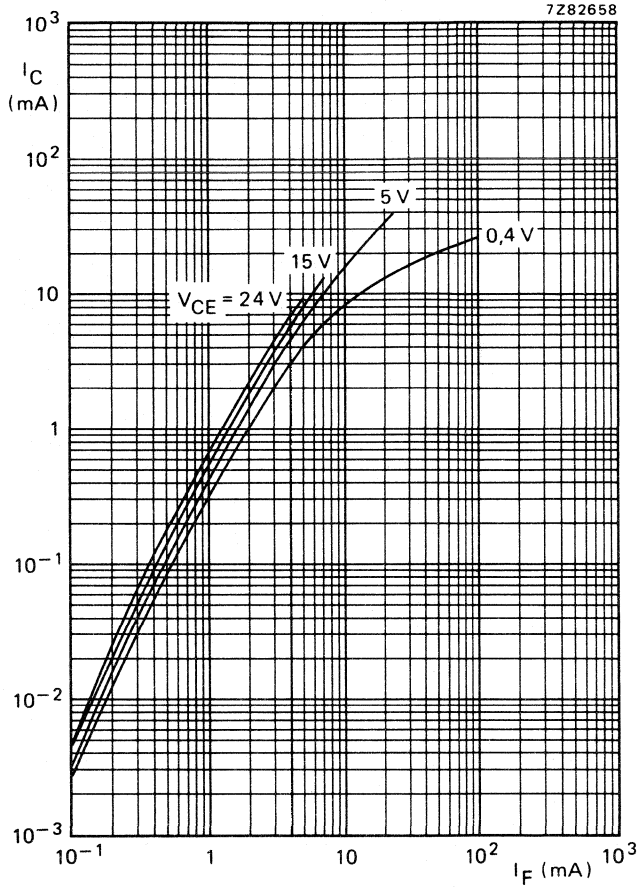

Fig. 13 $T_{amb} = 25^\circ\text{C}$, typical values.

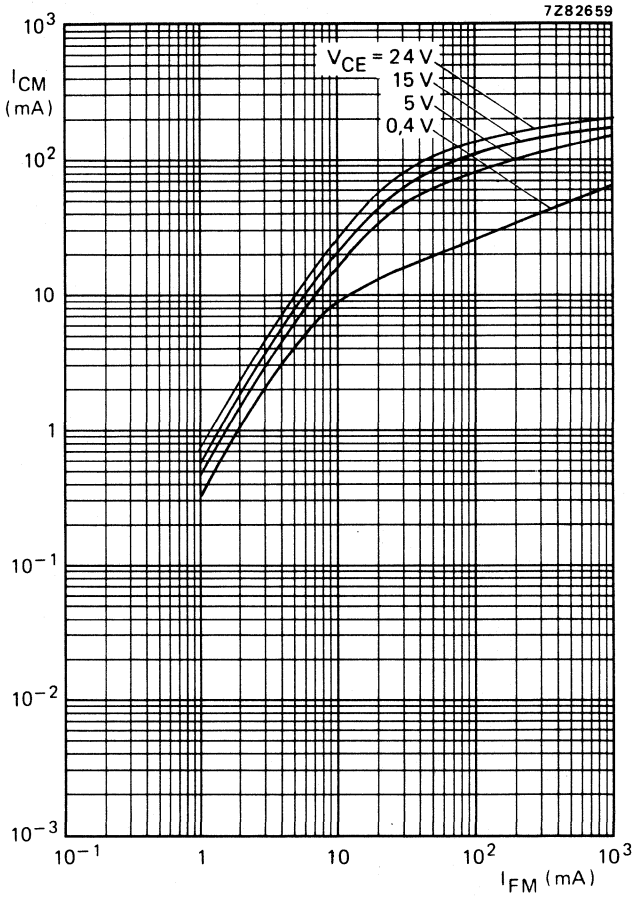

Fig. 14 $T_{amb} = 25$ °C; $t_p = 10$ μ s; $T = 1$ ms; typical values.

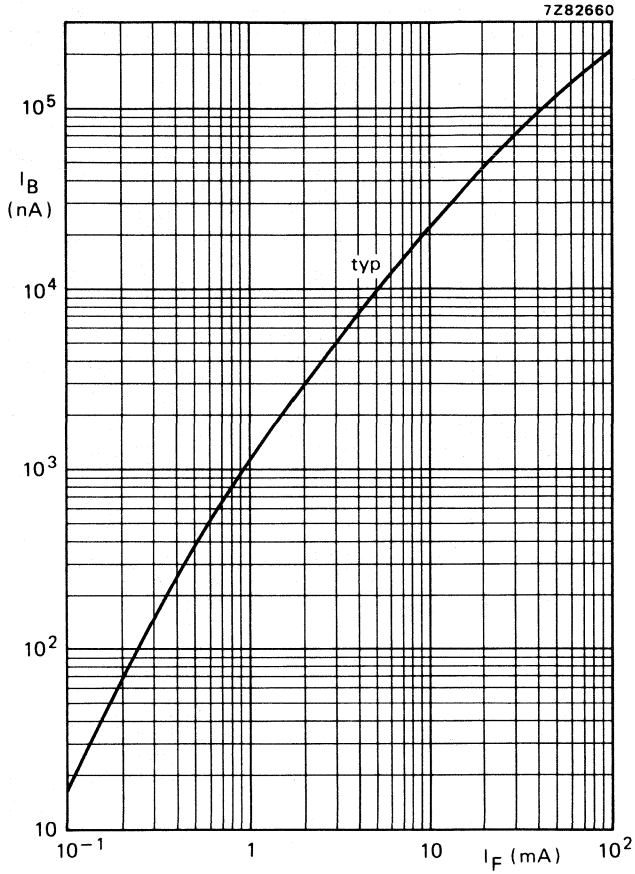

Fig. 15 $V_{CB} = 5 \text{ V}$; $T_{amb} = 25 \text{ }^\circ\text{C}$.

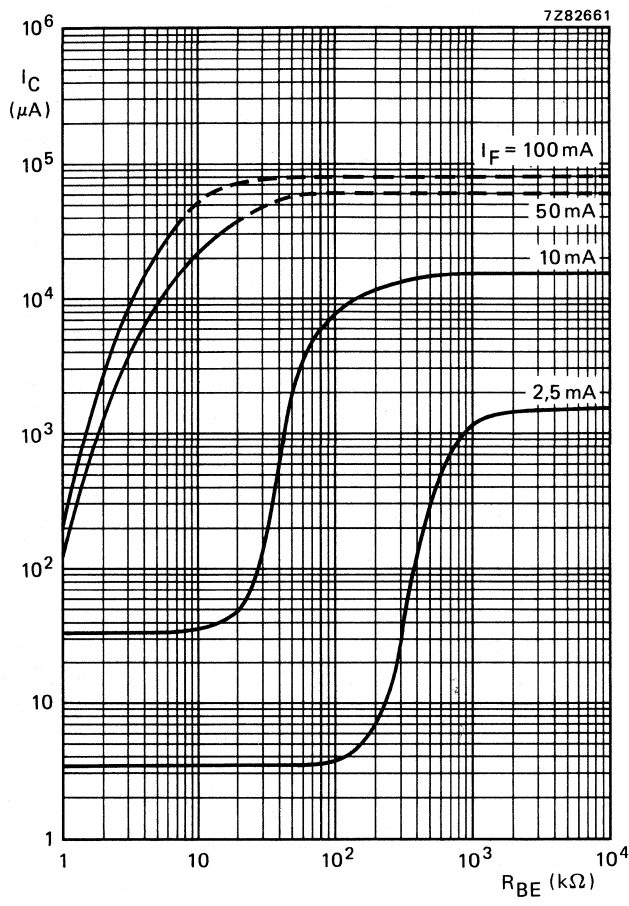

Fig. 16 $I_B = 0$; $V_{CE} = 5 \text{ V}$; $T_{amb} = 25 \text{ }^\circ\text{C}$; typical values.

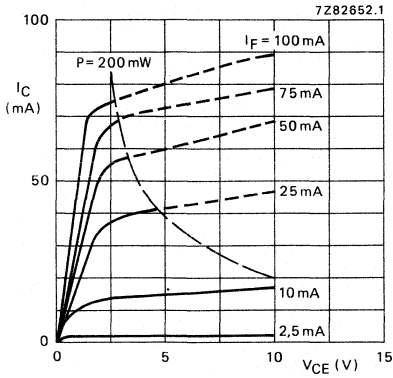

Fig. 17 $T_{amb} = 25 \text{ }^\circ\text{C}$; typical values.

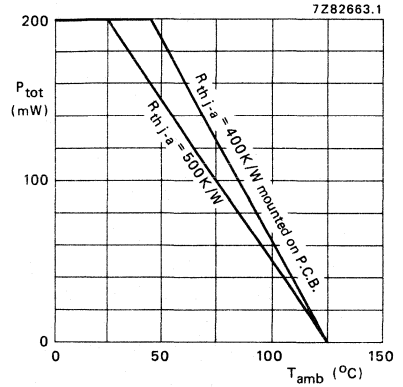

Fig. 18.

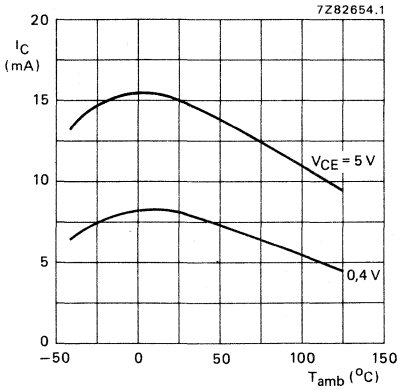

Fig. 19 $I_F = 10 \text{ mA}$; typical values.

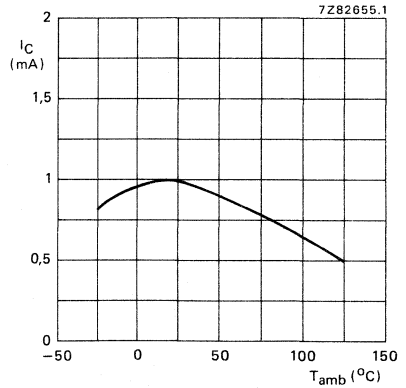

Fig. 20 $I_F = 2 \text{ mA}$; $V_{CE} = 0,4 \text{ V}$; typical values.

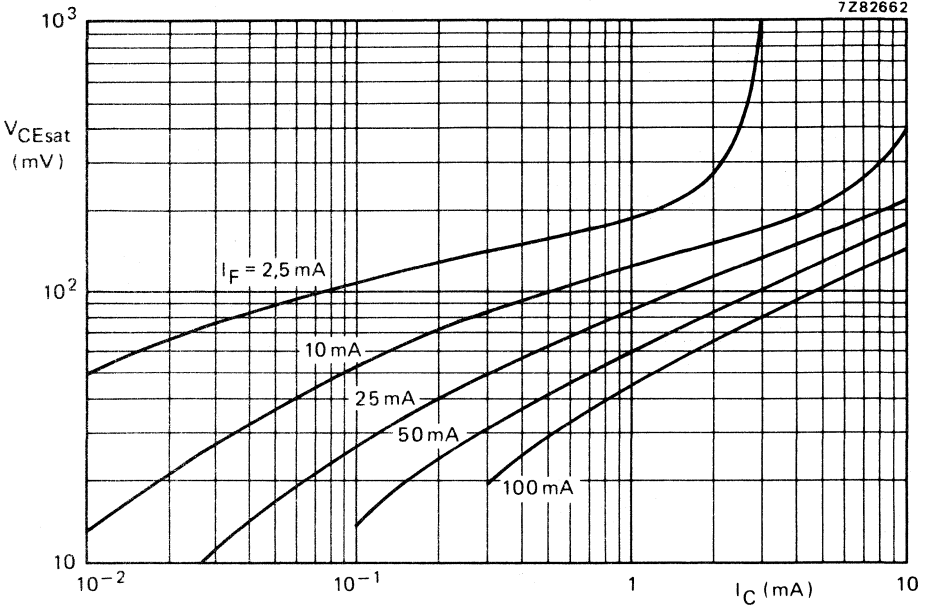

Fig. 21 $I_B = 0$; $T_{amb} = 25^\circ C$; typical values.

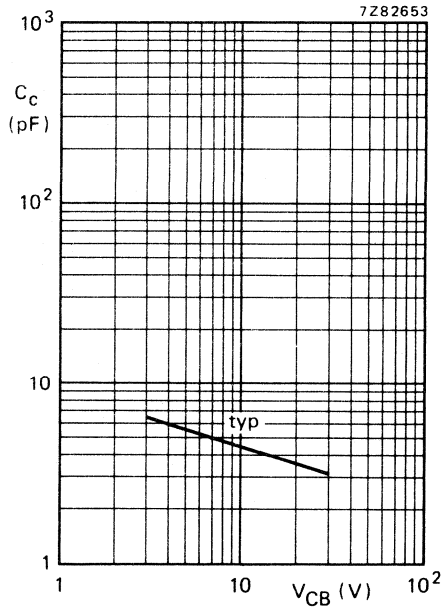

Fig. 22 $f = 1$ MHz; $T_{amb} = 25^\circ C$.

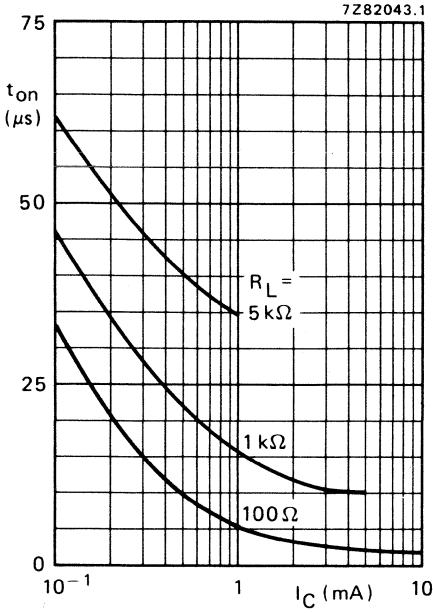

Fig. 23 $I_B = 0$; $V_{CC} = 5 V$; $T_{amb} = 25^\circ C$; typical values. (See also Fig. 25).

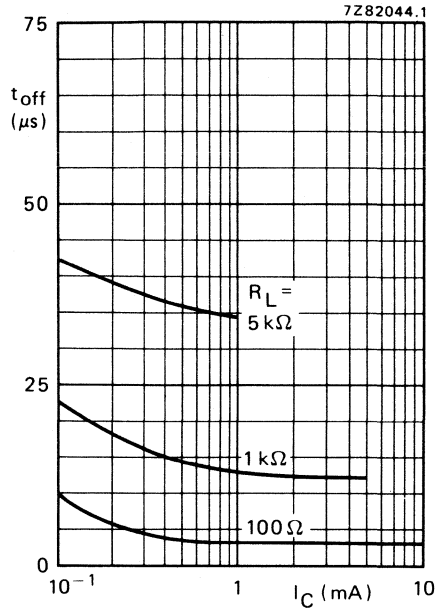

Fig. 24 $I_B = 0$; $V_{CC} = 5 V$; $T_{amb} = 25^\circ C$; typical values. (See also Fig. 25).

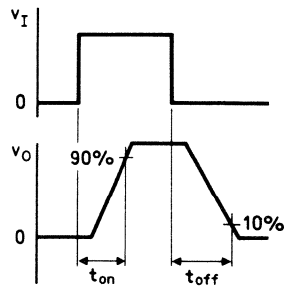
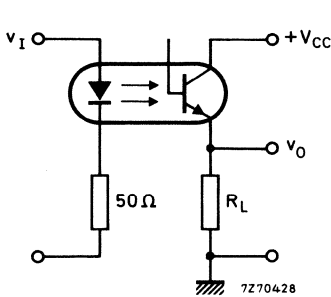

Fig. 25 Switching circuit and waveforms.

OPTOCOUPLER

Optically coupled isolator consisting of an infrared emitting GaAs diode and a silicon n-p-n photo-transistor with accessible base. Plastic envelope. Suitable for TTL integrated circuits.

Features of these products:

- high output/input d.c. current transfer ratio;
- low saturation voltage;
- high isolation voltage of 3,12 kV (r.m.s.) and 4,4 kV (d.c.);
- working voltage 2,5 kV (d.c.)

QUICK REFERENCE DATA

Diode

Continuous reverse voltage	V_R	max.	5 V
Forward current d.c.	I_F	max.	100 mA
(peak value); $t_p = 10 \mu s$; $\delta = 0,01$	I_{FRM}	max.	3 A
Total power dissipation up to $T_{amb} = 25^\circ C$	P_{tot}	max.	200 mW

Transistor

Collector-emitter voltage (open base)	V_{CEO}	max.	80 V
Total power dissipation up to $T_{amb} = 25^\circ C$	P_{tot}	max.	200 mW

Optocoupler

Output/input d.c. current transfer ratio (C.T.R.) $I_F = 10 \text{ mA}$; $V_{CE} = 10 \text{ V}$; ($I_B = 0$)	I_C/I_F		0,7 to 2,1
Collector cut-off current (dark) $V_{CC} = 10 \text{ V}$; working voltage (d.c.) = 2,5 kV diode; $I_F = 0$ (see also Fig. 4)	I_{CEW}	max.	200 nA
Isolation voltage (d.c.)	V_{IORM}	min.	4,4 kV

MECHANICAL DATA

SOT-90B (see Fig. 1).

MECHANICAL DATA

Dimensions in mm

→ Fig. 1 SOT-90B.

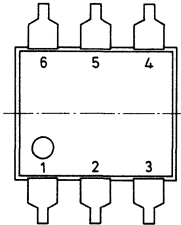
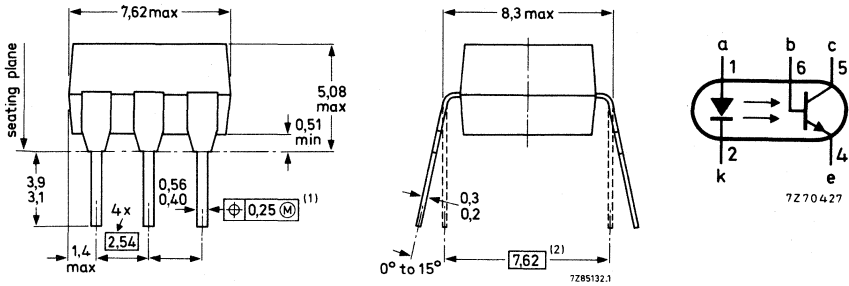

⊕ Positional accuracy.

(M) Maximum Material Condition.

- (1) Centre-lines of all leads are within $\pm 0,125$ mm of the nominal position shown; in the worst case, the spacing between any two leads may deviate from nominal by 0,25 mm.
- (2) When the leads are parallel, the tips are in position for automatic insertion.

RATINGS

Limiting values in accordance with the Absolute Maximum System (IEC 134)

Diode

→ Continuous reverse voltage

V_R max. 5 V

Forward current

I_F max. 100 mA

d.c.

I_{FRM} max. 3 A

(peak value); $t_p = 10 \mu s$; $\delta = 0,01$

Total power dissipation up to $T_{amb} = 25 \text{ }^\circ\text{C}$

P_{tot} max. 200 mW

Transistor

Collector-base voltage (open emitter)

V_{CBO} max. 120 V

Collector-emitter voltage (open base)

V_{CEO} max. 80 V

Emitter-collector voltage (open base)

V_{ECO} max. 7 V

Collector current (d.c.)

I_C max. 100 mA

Total power dissipation up to $T_{amb} = 25 \text{ }^\circ\text{C}$

P_{tot} max. 200 mW

Optocoupler

Storage temperature	T_{stg}	-55 to +150 °C	←
Operating junction temperature	T_j	max. 125 °C	
Lead soldering temperature up to the seating plane; $t_{sld} < 10$ s	T_{sld}	max. 260 °C	

THERMAL RESISTANCE

From junction to ambient in free air diode	$R_{th\ j-a}$	=	500 K/W
transistor	$R_{th\ j-a}$	=	500 K/W
From junction to ambient, device mounted on a printed-circuit board diode	$R_{th\ j-a}$	=	400 K/W
transistor	$R_{th\ j-a}$	=	400 K/W

ISOLATION RELATED VALUES

External air gap (clearance) input terminals to output terminals	$L(I01)$	min.	7,2 mm
External tracking path (creepage dist) input terminals to output terminals	$L(I02)$	min.	7,0 mm
Tracking resistance (KB-value)			KB-100/A

CHARACTERISTICS

$T_j = 25$ °C unless otherwise specified

Diode

Forward voltage $I_F = 10$ mA	V_F	typ. <	1,15 V 1,5 V	
Reverse current $V_R = 5$ V	I_R	<	10 μ A	←

Transistor ($I_F = 0$)

Collector cut-off current (dark) $V_{CE} = 50$ V	I_{CEO}	typ. <	2 nA 50 nA
$V_{CE} = 50$ V; $T_{amb} = 70$ °C	I_{CEO}	<	10 μ A
$V_{CB} = 10$ V; $T_{amb} = 25$ °C	I_{CBO}	<	20 nA
Collector-emitter breakdown voltage at $I_C = 1$ mA	$V_{(BR)CEO}$	min.	80 V
Collector-base breakdown voltage at $I_C = 0,1$ mA	$V_{(BR)CBO}$	min.	120 V
Emitter-collector breakdown voltage at $I_E = 0,1$ mA	$V_{(BR)ECO}$	min.	7 V

→ **Optocoupler ($I_B = 0$)***

Output/input d.c. current transfer ratio (C.T.R.)

$I_F = 10 \text{ mA}; V_{CE} = 10 \text{ V}$

$I_F = 16 \text{ mA}; V_{CE} = 0,4 \text{ V}$

I_C/I_F		0,7 to 2,1
I_C/I_F	>	0,5

Collector-emitter saturation voltage

$I_F = 16 \text{ mA}; I_C = 2 \text{ mA}$

V_{CEsat}	typ.	0,2 V
	<	0,4 V

Isolation voltage **

V_{IORM}	min.	4,4 kV(d.c.) 3,12 kV (r.m.s.)
------------	------	----------------------------------

Collector capacitance at $f = 1 \text{ MHz}$

$I_E = I_C = 0; V_{CB} = 10 \text{ V}$

C_c	typ.	4,5 pF
-------	------	--------

Capacitance between input and output

$I_F = 0; V = 0; f = 1 \text{ MHz}$

C_{io}	typ.	0,6 pF
----------	------	--------

Insulation resistance between input and output

$\pm V_{IO} = 1 \text{ kV}$

r_{IO}	>	$10^{10} \Omega$
	typ.	$10^{12} \Omega$

Switching times (see Figs 2 and 3)

$I_{Con} = 4 \text{ mA}; V_{CC} = 5 \text{ V}; R_L = 100 \Omega$

Turn-on time

t_{on}	typ.	5 μs
----------	------	-----------------

Turn-off time

t_{off}	typ.	5 μs
-----------	------	-----------------

→ $I_{Con} = 4 \text{ mA}; V_{CC} = 5 \text{ V}; R_L = 1 \text{ k}\Omega$

Turn-on time

t_{on}	typ.	15 μs
----------	------	------------------

Turn-off time

t_{off}	typ.	15 μs
-----------	------	------------------

Collector cut-off current

$V_F = 0,8 \text{ V}; -V_{CE} = 15 \text{ V}$

$T_{amb} = 0 \text{ }^\circ\text{C to } +70 \text{ }^\circ\text{C}$

I_{CE1}	max.	15 μA
-----------	------	------------------

Collector cut-off current

at $I_F = 2 \text{ mA}; -V_{CE} = 0,4 \text{ V}$

$T_{amb} = 0 \text{ }^\circ\text{C to } +70 \text{ }^\circ\text{C}$

I_{CE2}	min.	150 μA
-----------	------	-------------------

Collector cut-off current (dark) see Fig. 4

$V_{CC} = 10 \text{ V};$ working voltage (d.c.) = 1,5 kV

$V_{CC} = 10 \text{ V};$ working voltage (d.c.) = 1,5 kV; $T_j = 70 \text{ }^\circ\text{C}$

I_{CEW}	<	200 nA▲
I_{CEW}	<	100 μA ▲

* Where the phototransistor receives light from the diode the O (for open base) has been omitted from the symbols.

** Tested on a sample basis with a voltage of 4400 Vdc for 1 minute between the shorted input (diode) leads and the shorted output (phototransistor) leads.

▲ As quality assurance (on a sample basis), these parameters are covered by a 1000 h reliability test.

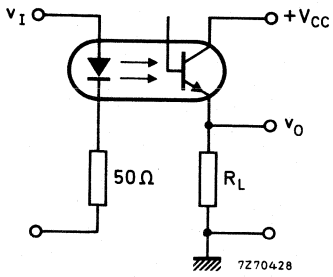

Fig. 2 Switching circuit.

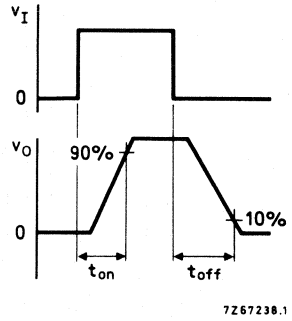

Fig. 3 Waveforms.

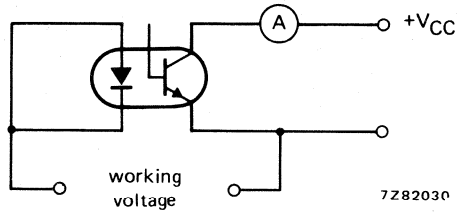

Fig. 4.

7Z82710

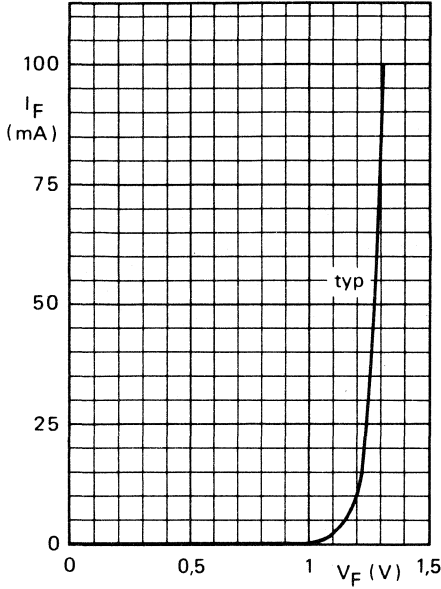

Fig. 5 $T_{amb} = 25\text{ }^{\circ}\text{C}$.

7Z82647

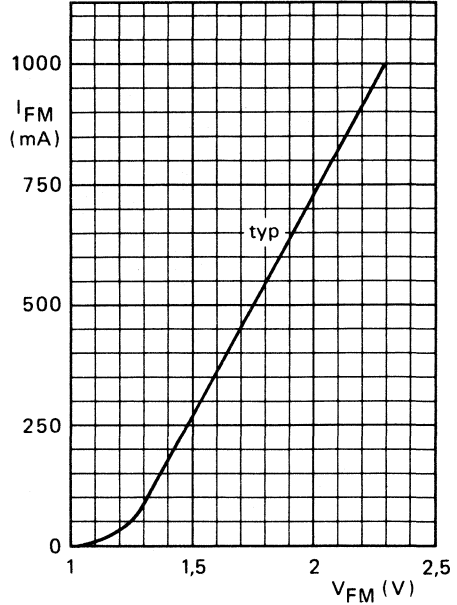

Fig. 6 $T_{amb} = 25\text{ }^{\circ}\text{C}$; $t_p = 10\text{ }\mu\text{s}$; $T = 1\text{ ms}$.

7Z82648

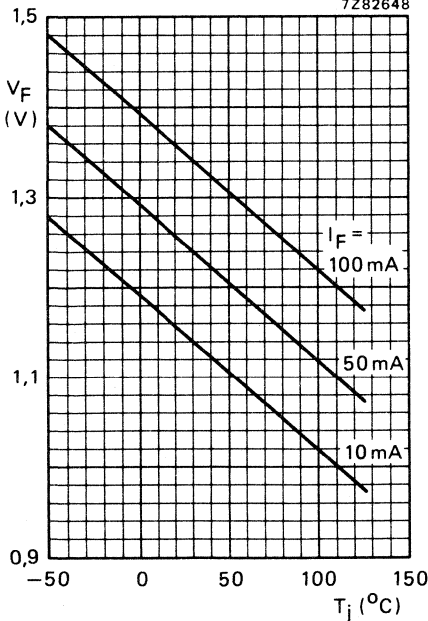

Fig. 7 Typical values.

7Z82649

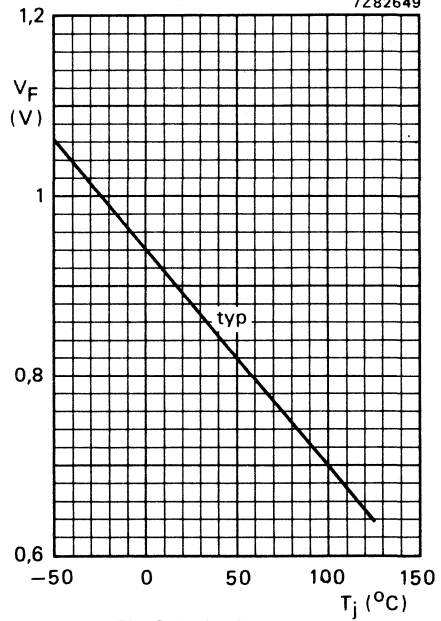

Fig. 8 $I_F = 50\text{ }\mu\text{A}$.

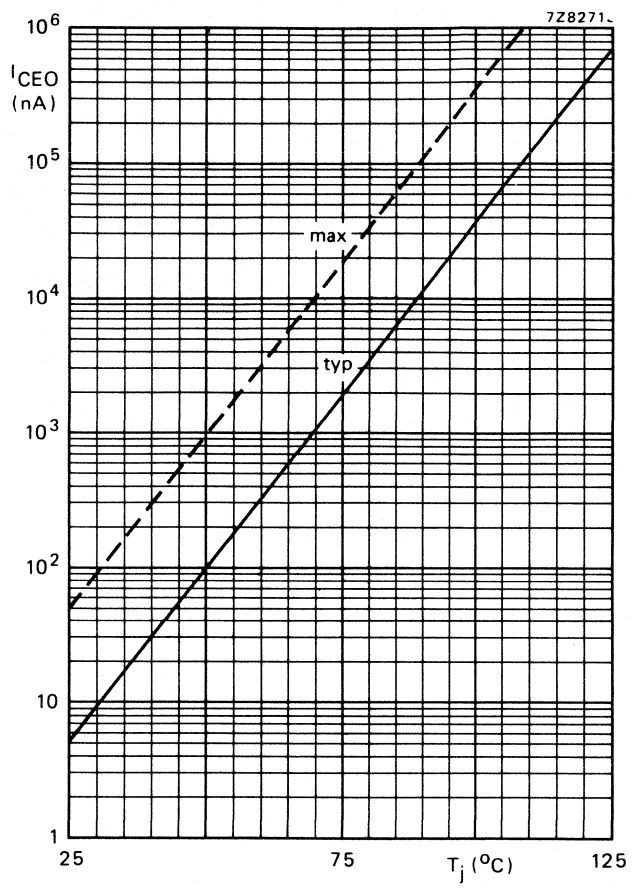

Fig. 9 $I_F = 0$; $V_{CE} = 10 \text{ V}$.

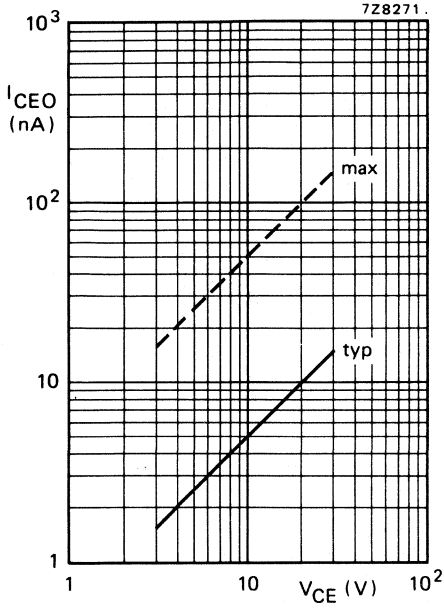

Fig. 10 $I_F = 0$; $T_j = 25^\circ\text{C}$.

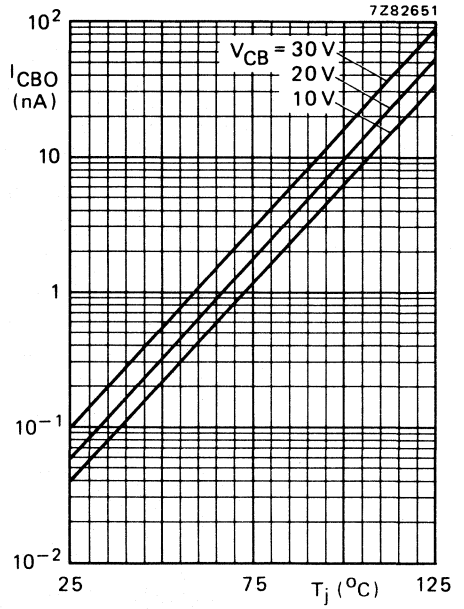

Fig. 11 Typical values.

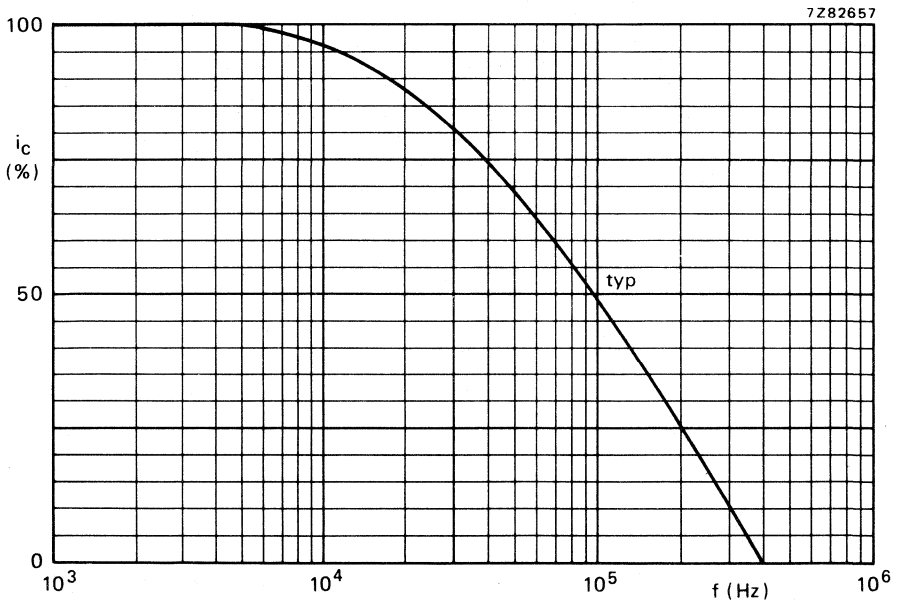

Fig. 12 $I_B = 0$; $I_C = 2\text{ mA}$; $V_{CC} = 5\text{ V}$, $R_L = 1\text{ k}\Omega$; $T_{\text{amb}} = 25^\circ\text{C}$.

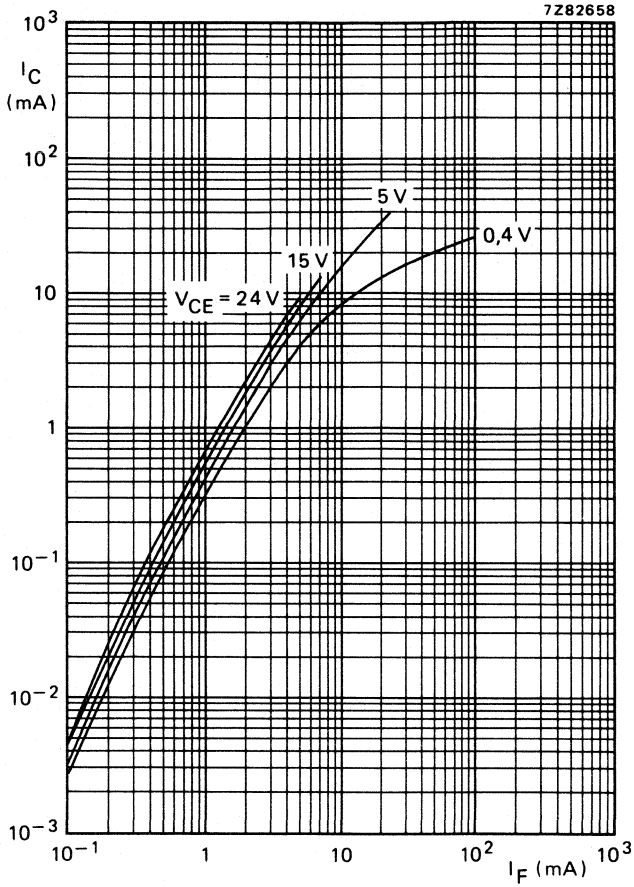

Fig. 13 $T_{amb} = 25\text{ }^{\circ}\text{C}$, typical values.

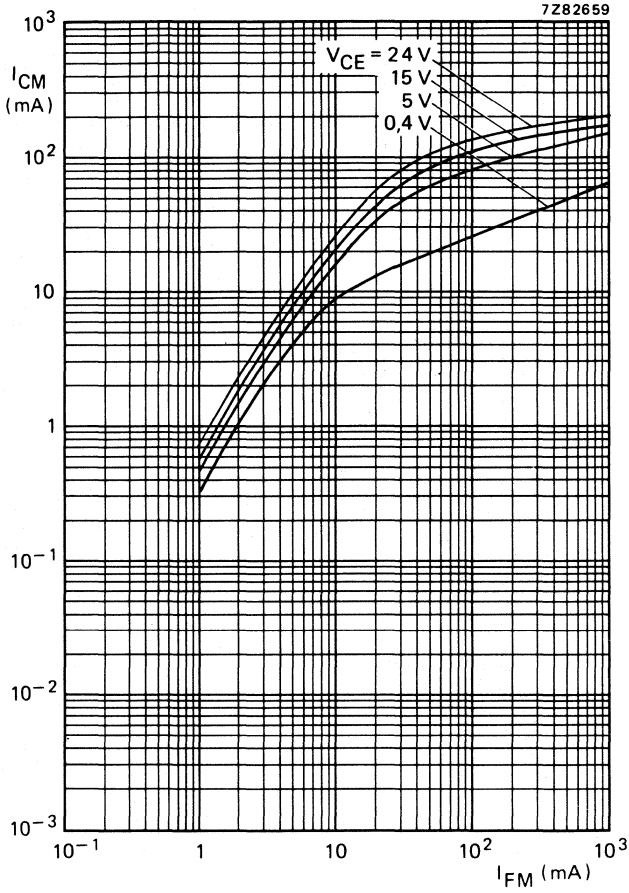

Fig. 14 $T_{amb} = 25^{\circ}C$; $t_p = 20 \mu s$; $T = 2 ms$; typical values.

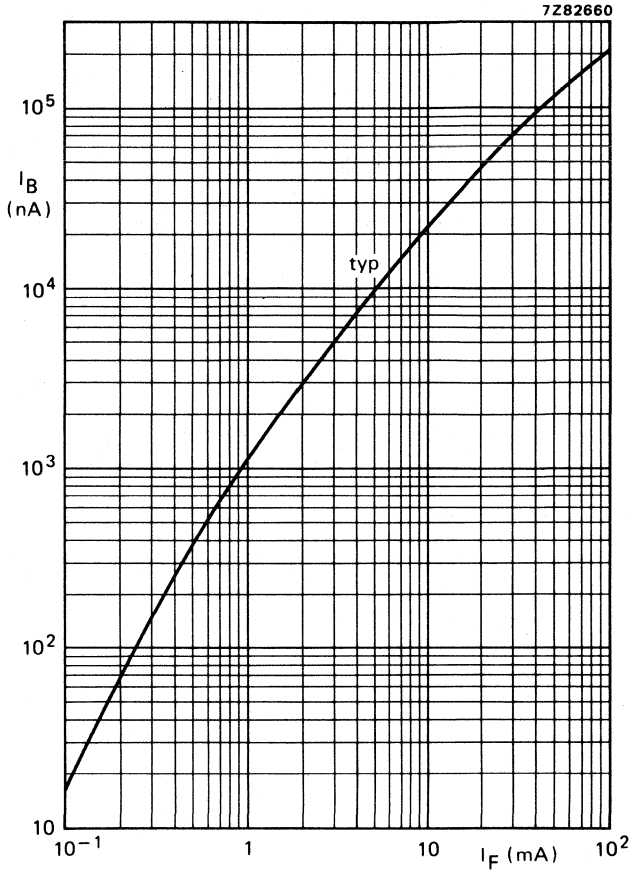

Fig. 15 $V_{CB} = 5\text{ V}$; $T_{amb} = 25\text{ }^\circ\text{C}$.

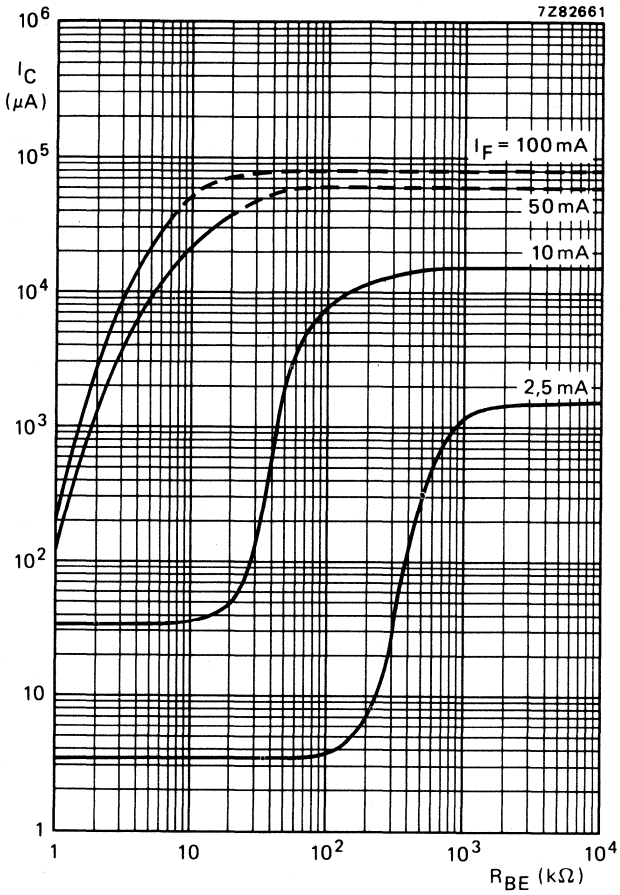

Fig. 16 $I_B = 0$; $V_{CE} = 5 \text{ V}$; $T_{amb} = 25 \text{ }^\circ\text{C}$; typical values.

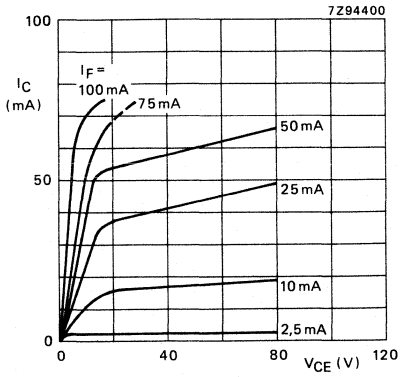

Fig. 17 $T_{amb} = 25\text{ }^{\circ}\text{C}$; typical values.

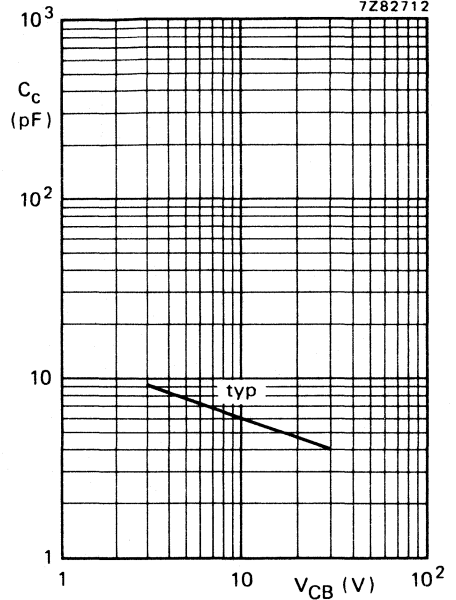

Fig. 18 $f = 1\text{ MHz}$; $T_{amb} = 25\text{ }^{\circ}\text{C}$.

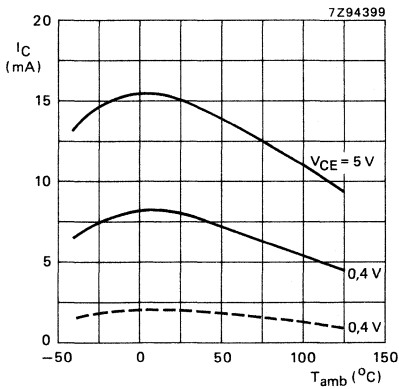

Fig. 19 $I_F = 10\text{ mA}$; typical values.

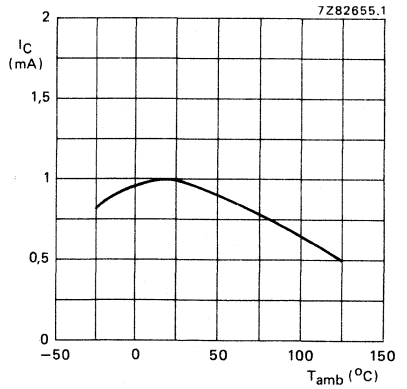

Fig. 20 $I_F = 2\text{ mA}$; typical values.

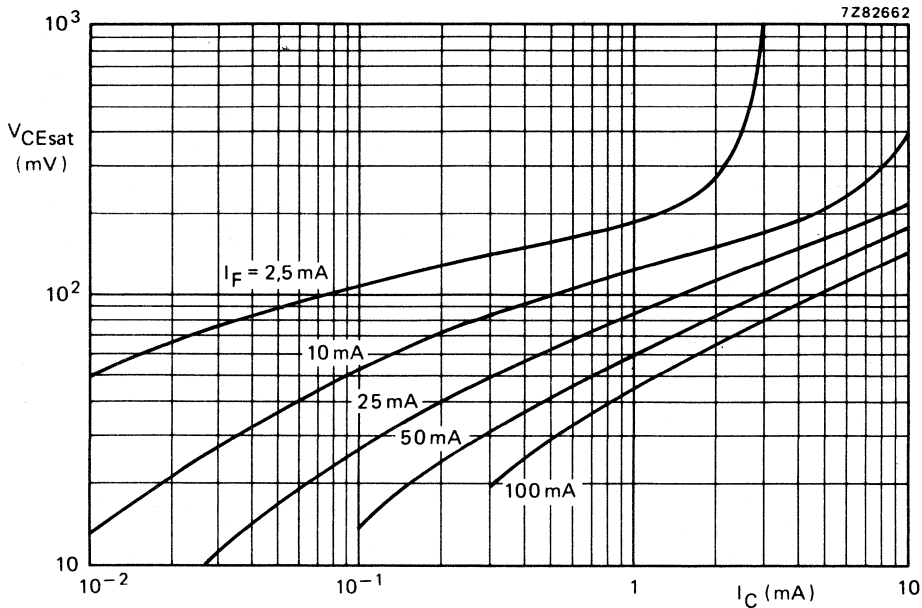

Fig. 21 $I_B = 0$; $T_{amb} = 25$ °C; typical values.

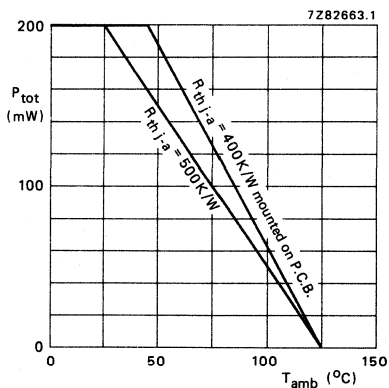

Fig. 22 Max. permissible power dissipation for total device versus ambient temperature.

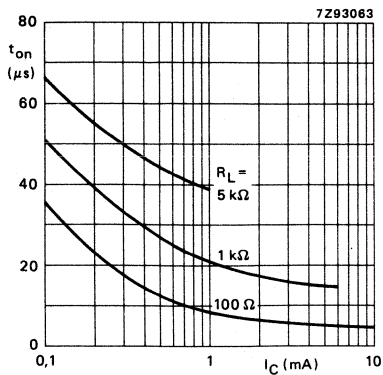

Fig. 23 $I_B = 0$; $V_{CC} = 5\text{ V}$; $T_{amb} = 25\text{ }^\circ\text{C}$; typical values. (See also Fig. 25.)

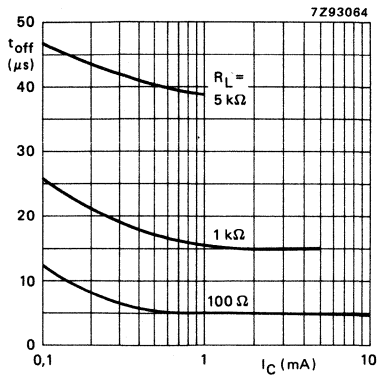

Fig. 24 $I_B = 0$; $V_{CC} = 5\text{ V}$; $T_{amb} = 25\text{ }^\circ\text{C}$, typical values. (See also Fig. 25.)

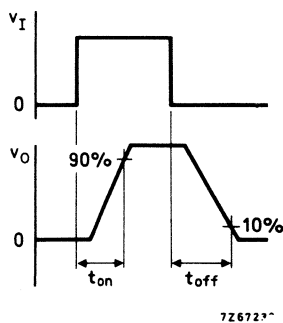
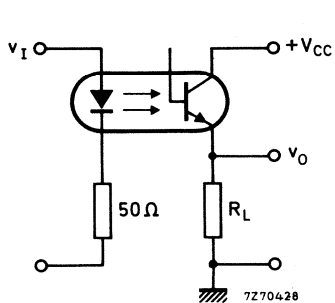

Fig. 25 Switching circuit and waveforms.

OPTOCOUPLER



Optically coupled isolator consisting of an infrared emitting GaAs diode and a high voltage silicon n-p-n phototransistor with assessible base. Plastic envelope. Suitable for TTL integrated circuits.

Features of this product:

- high output/input d.c. current transfer ratio;
- low saturation voltage;
- high isolation voltage of 3,12 kV (r.m.s.) and 4,4 kV (d.c.)
- working voltage 2,5 kV (d.c.)

UL — Covered under UL component recognition FILE E90700

VDE — Approved according to VDE 0883/6.83

Complied for reinforced isolation at 250 VAC with:

DIN 57 804/VDE 0804/1.83 (isolation group C)

DIN IEC 65/VDE 0860/8.81

QUICK REFERENCE DATA

Diode

Continuous reverse voltage	V_R	max.	5 V	←
Forward current d.c. (peak value); $t_p = 10 \mu s$; $\delta = 0,01$	I_F	max.	100 mA	
	I_{FRM}	max.	3 A	
Total power dissipation up to $T_{amb} = 25 \text{ }^\circ\text{C}$	P_{tot}	max.	200 mW	

Transistor

Collector-emitter voltage (open base)	V_{CEO}	max.	80 V	
Total power dissipation up to $T_{amb} = 25 \text{ }^\circ\text{C}$	P_{tot}	max.	200 mW	

Optocoupler

Output/input d.c. current transfer ratio (C.T.R.) $I_F = 10 \text{ mA}$; $V_{CE} = 10 \text{ V}$; ($I_B = 0$)	I_C/I_F		0,7 to 2,1	
Collector cut-off current (dark) $V_{CC} = 10 \text{ V}$; working voltage (d.c.) = 2,5 kV diode; $I_F = 0$ (see also Fig. 4)	I_{CEW}	max.	200 nA	
Isolation voltage (d.c.)	V_{IORM}	min.	4,4 kV	

MECHANICAL DATA

SOT-90B (see Fig. 1).

MECHANICAL DATA

Dimensions in mm

→ Fig. 1 SOT-90B.

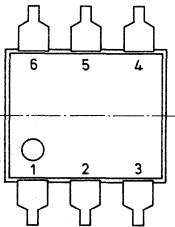
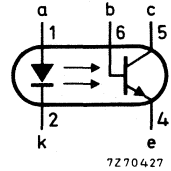
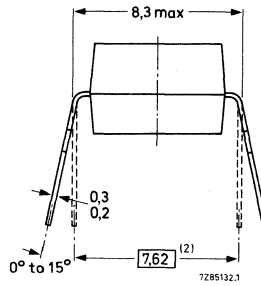
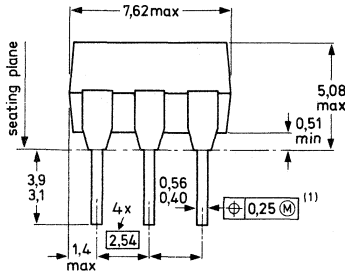

⊕ Positional accuracy.

Ⓜ Maximum Material Condition.

- (1) Centre-lines of all leads are within $\pm 0,125$ mm of the nominal position shown; in the worst case, the spacing between any two leads may deviate from nominal by 0,25 mm.
- (2) When the leads are parallel, the tips are in position for automatic insertion.

RATINGS

Limiting values in accordance with the Absolute Maximum System (IEC 134)

Diode

→ Continuous reverse voltage	V_R	max.	5 V
Forward current	I_F	max.	100 mA
d.c.	I_{FRM}	max.	3 A
(peak value); $t_p = 10 \mu s$; $\delta = 0,01$	P_{tot}	max.	200 mW
Total power dissipation up to $T_{amb} = 25 \text{ }^\circ\text{C}$			

Transistor

Collector-base voltage (open emitter)	V_{CBO}	max.	120 V
Collector-emitter voltage (open base)	V_{CEO}	max.	80 V
Emitter-collector voltage (open base)	V_{ECO}	max.	7 V
Collector current (d.c.)	I_C	max.	100 mA
Total power dissipation up to $T_{amb} = 25 \text{ }^\circ\text{C}$	P_{tot}	max.	200 mW

Optocoupler

Storage temperature	T_{stg}	-55 to +150 °C	←
Operating junction temperature	T_j	max. 125 °C	
Lead soldering temperature up to the seating plane; $t_{sld} < 10$ s	T_{sld}	max. 260 °C	

THERMAL RESISTANCE

From junction to ambient in free air diode	$R_{th\ j-a}$	=	500 K/W
transistor	$R_{th\ j-a}$	=	500 K/W
From junction to ambient, device mounted on a printed-circuit board diode	$R_{th\ j-a}$	=	400 K/W
transistor	$R_{th\ j-a}$	=	400 K/W

ISOLATION RELATED VALUES

External air gap (clearance) input terminals to output terminals	$L(I01)$	min.	7,2 mm
External tracking path (creepage dist) input terminals to output terminals	$L(I02)$	min.	7,0 mm
Tracking resistance (KB-value)			KB-100/A

CHARACTERISTICS

$T_j = 25$ °C unless otherwise specified

Diode

Forward voltage $I_F = 10$ mA	V_F	typ. <	1,15 V 1,5 V
Reverse current $V_R = 5$ V	I_R	<	10 μ A ←

Transistor ($I_F = 0$)

Collector cut-off current (dark) $V_{CE} = 50$ V	I_{CEO}	typ. <	2 nA 50 nA
$V_{CE} = 50$ V; $T_{amb} = 70$ °C	I_{CEO}	<	10 μ A
$V_{CB} = 10$ V; $T_{amb} = 25$ °C	I_{CBO}	<	20 nA
Collector-emitter breakdown voltage at $I_C = 1$ mA	$V_{(BR)CEO}$	min.	80 V
Collector-base breakdown voltage at $I_C = 0,1$ mA	$V_{(BR)CBO}$	min.	120 V
Emitter-collector breakdown voltage at $I_E = 0,1$ mA	$V_{(BR)ECO}$	min.	7 V

→ **Optocoupler ($I_B = 0$)***

Output/input d.c. current transfer ratio (C.T.R.)

$I_F = 10 \text{ mA}; V_{CE} = 10 \text{ V}$

$I_F = 16 \text{ mA}; V_{CE} = 0,4 \text{ V}$

Collector-emitter saturation voltage

$I_F = 16 \text{ mA}; I_C = 2 \text{ mA}$

I_C/I_F 0,7 to 2,1
 $I_C/I_F >$ 0,5

V_{CEsat} typ. 0,2 V
 $V_{CEsat} <$ 0,4 V

→ **Isolation voltage****

Collector capacitance at $f = 1 \text{ MHz}$

$I_E = I_B = 0; V_{CB} = 10 \text{ V}$

Capacitance between input and output

$I_F = 0; V = 0; f = 1 \text{ MHz}$

Insulation resistance between input and output

$\pm V_{IO} = 1 \text{ kV}$

V_{IORM} min. 4,4 kV(d.c.)
 3,12 kV(r.m.s.)

C_c typ. 4,5 pF

C_{io} typ. 0,6 pF

r_{IO} $>$ $10^{11} \Omega$
 typ. $10^{12} \Omega$

Switching times (see Figs 2 and 3)

$I_{Con} = 4 \text{ mA}; V_{CC} = 5 \text{ V}; R_L = 100 \Omega$

Turn-on time

Turn-off time

t_{on} typ. 5 μs

t_{off} typ. 5 μs

→ $I_{Con} = 4 \text{ mA}; V_{CC} = 5 \text{ V}; R_L = 1 \text{ k}\Omega$

Turn-on time

Turn-off time

t_{on} typ. 15 μs

t_{off} typ. 15 μs

Collector cut-off current

$V_F = 0,8 \text{ V}; -V_{CE} = 15 \text{ V}$

$T_{amb} = 0 \text{ }^\circ\text{C to } +70 \text{ }^\circ\text{C}$

I_{CE1} max. 15 μA

Collector cut-off current

at $I_F = 2 \text{ mA}; -V_{CE} = 0,4 \text{ V}$

$T_{amb} = 0 \text{ }^\circ\text{C to } +70 \text{ }^\circ\text{C}$

I_{CE2} min. 150 μA

Collector cut-off current (dark) see Fig. 4

$V_{CC} = 10 \text{ V};$ working voltage (d.c.) = 1,5 kV

$V_{CC} = 10 \text{ V};$ working voltage (d.c.) = 1,5 kV; $T_j = 70 \text{ }^\circ\text{C}$

$I_{CEW} <$ 200 nA \blacktriangle

$I_{CEW} <$ 100 μA \blacktriangle

* Where the phototransistor receives light from the diode the O (for open base) has been omitted from the symbols.

** Every single product is tested by applying an isolation test voltage of 3750 V (r.m.s.) for 2 seconds between the shorted input (diode) leads and the shorted output (phototransistor) leads.

\blacktriangle As quality assurance (on a sample basis), these parameters are covered by a 1000 h reliability test.

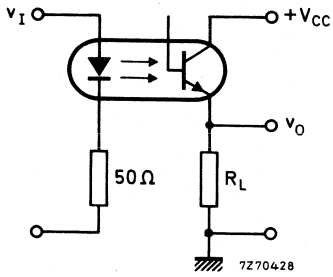

Fig. 2 Switching circuit.

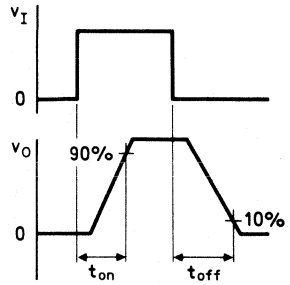

Fig. 3 Waveforms.

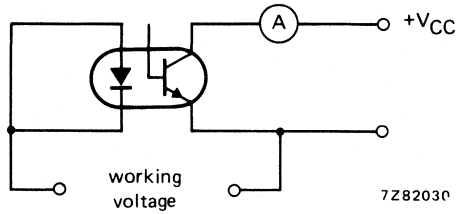

Fig. 4.

7282710

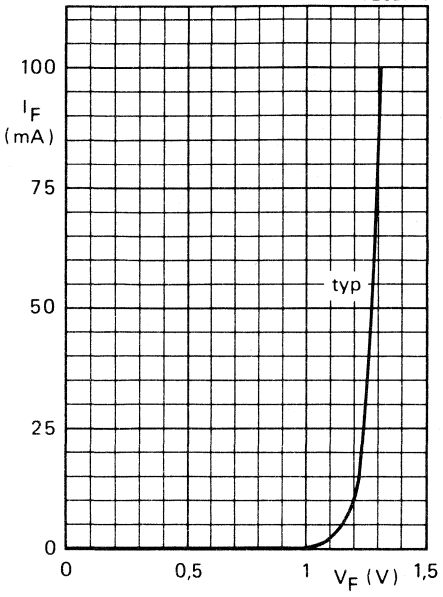

Fig. 5 $T_{amb} = 25\text{ }^{\circ}\text{C}$.

7282647

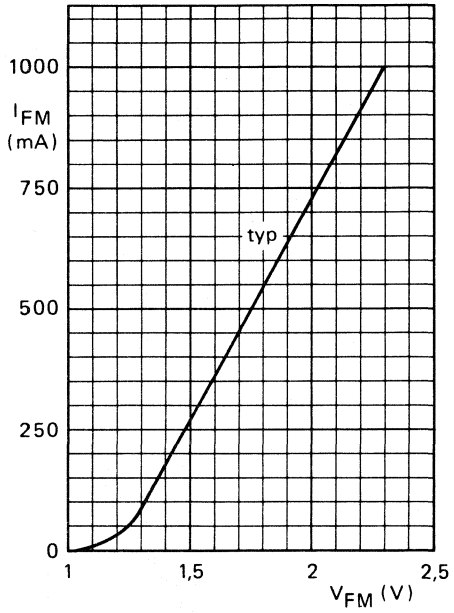

Fig. 6 $T_{amb} = 25\text{ }^{\circ}\text{C}$; $t_p = 10\text{ }\mu\text{s}$; $T = 1\text{ ms}$.

7282648

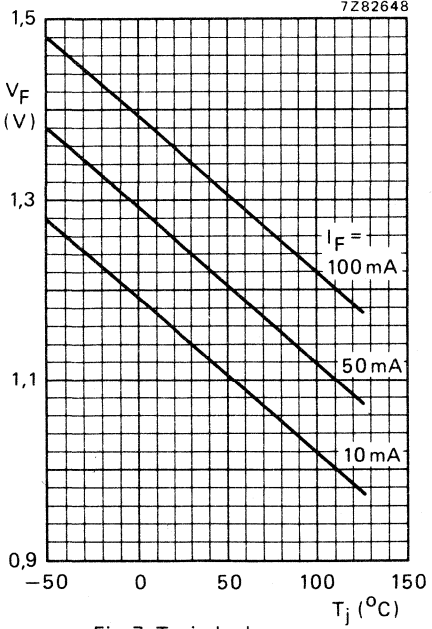

Fig. 7 Typical values.

7282649

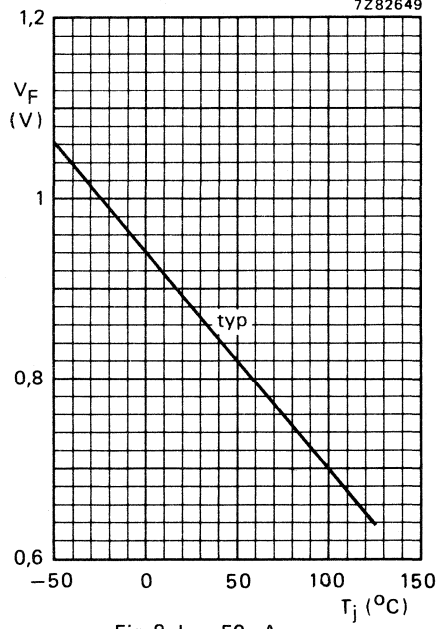

Fig. 8 $I_F = 50\text{ }\mu\text{A}$.

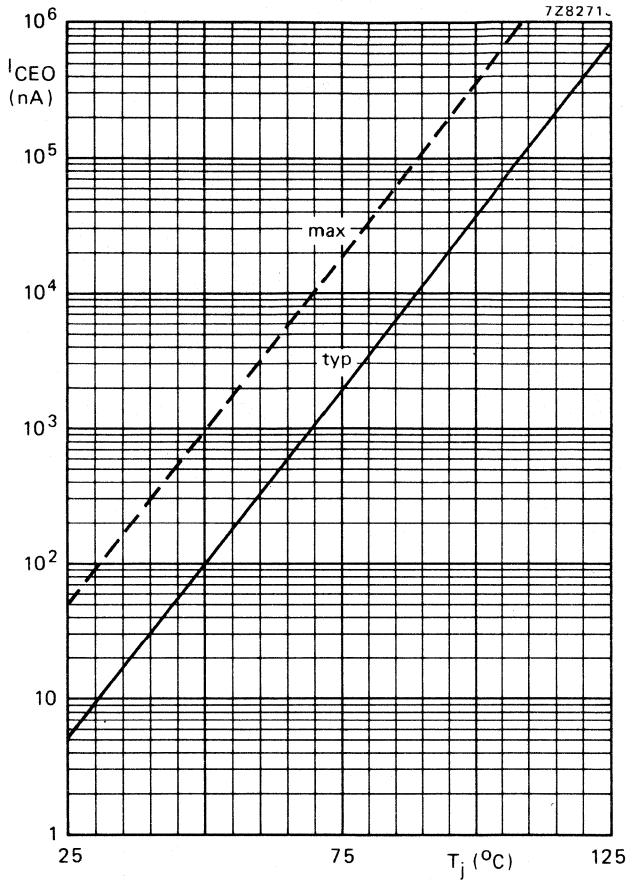

Fig. 9 $I_F = 0$; $V_{CE} = 10$ V.

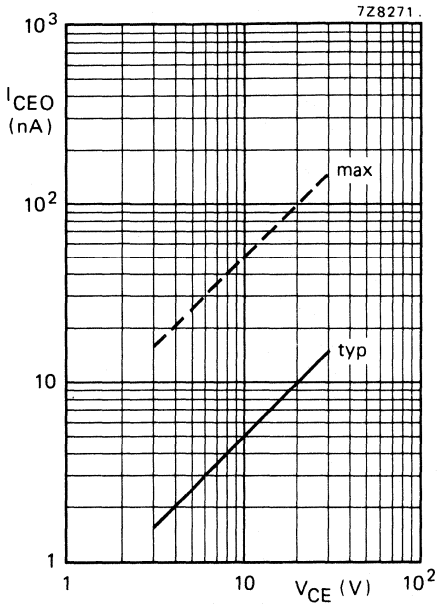

Fig. 10 $I_F = 0$; $T_j = 25^\circ\text{C}$.

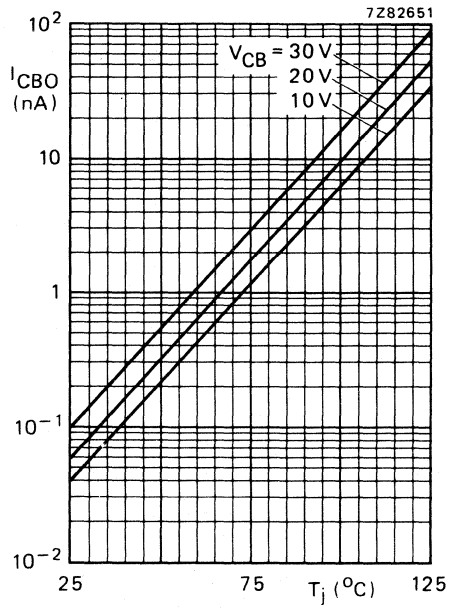

Fig. 11 Typical values.

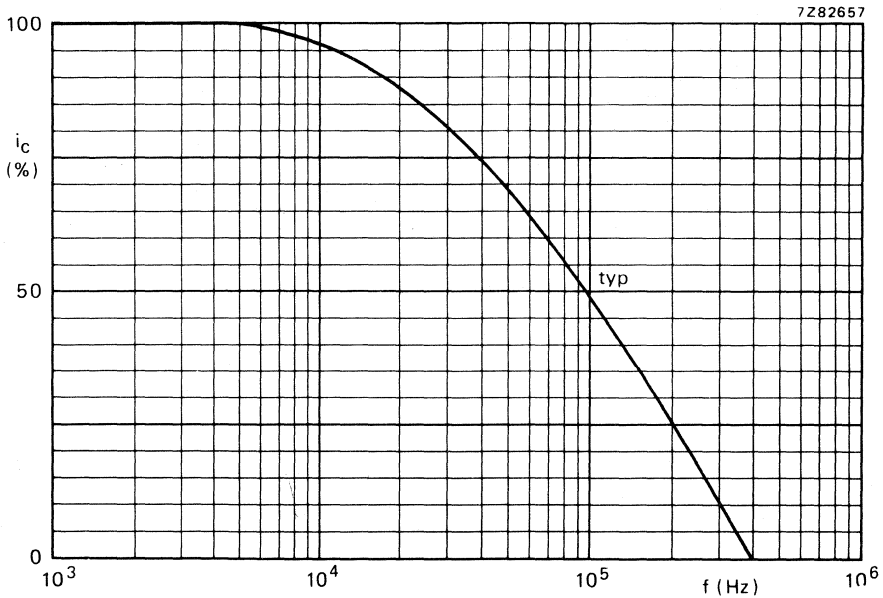

Fig. 12 $I_B = 0$; $I_C = 2\text{ mA}$; $V_{CC} = 5\text{ V}$, $R_L = 1\text{ k}\Omega$; $T_{amb} = 25^\circ\text{C}$.

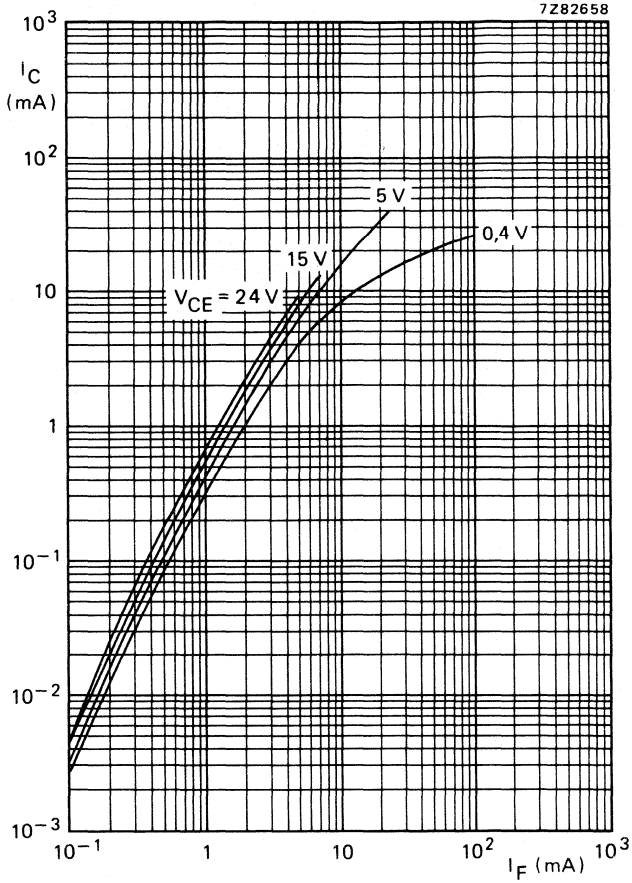

Fig. 13 $T_{amb} = 25$ °C, typical values.

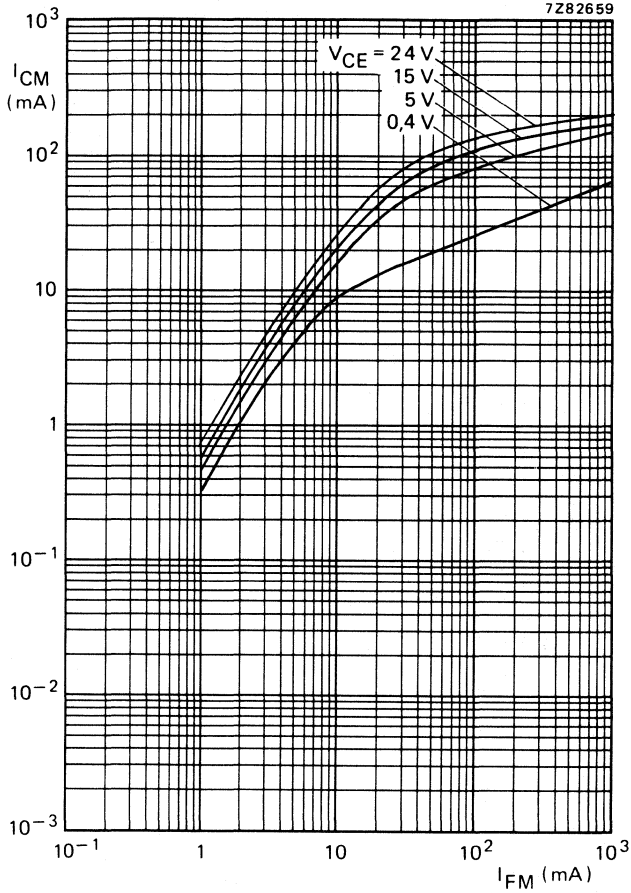

Fig. 14 $T_{amb} = 25$ °C; $t_p = 20$ μ s; $T = 2$ ms; typical values.

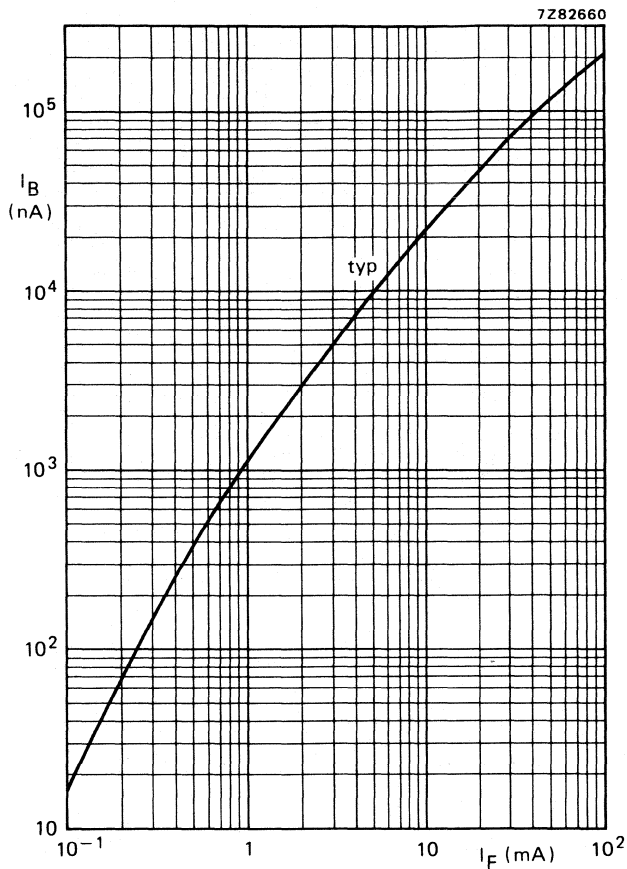

Fig. 15 $V_{CB} = 5 \text{ V}$; $T_{amb} = 25 \text{ }^\circ\text{C}$.

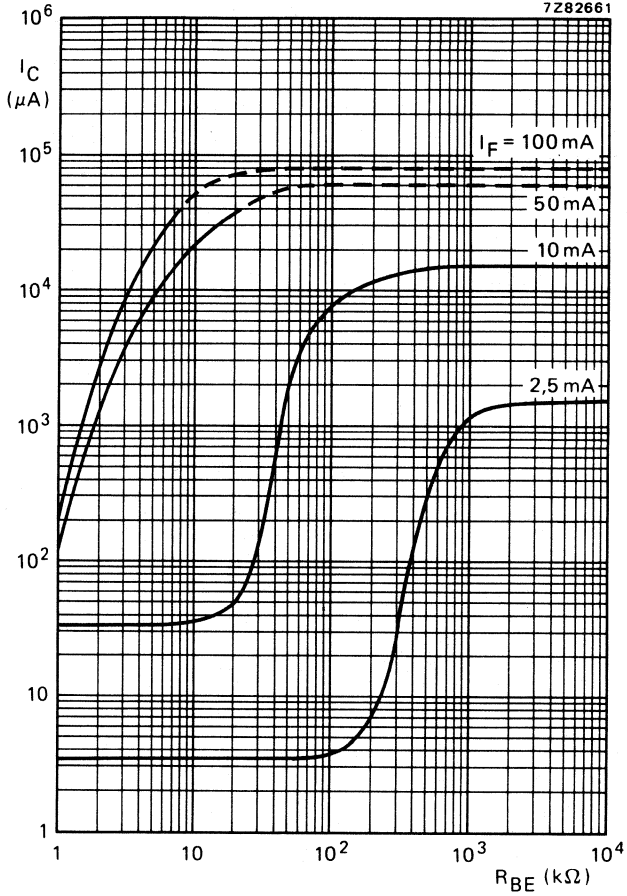

Fig. 16 $I_B = 0$; $V_{CE} = 5 \text{ V}$; $T_{amb} = 25 \text{ }^\circ\text{C}$; typical values.

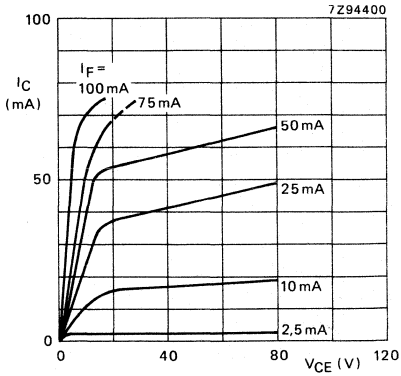

Fig. 17 $T_{amb} = 25^\circ\text{C}$; typical values.

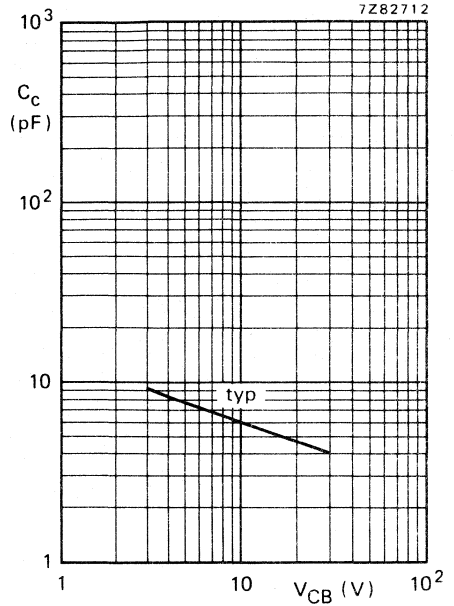

Fig. 18 $f = 1\text{ MHz}$; $T_{amb} = 25^\circ\text{C}$.

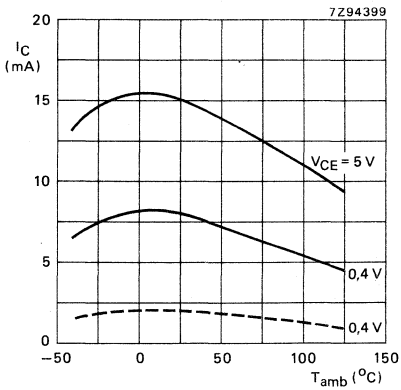

Fig. 19 $I_F = 10\text{ mA}$; typical values.

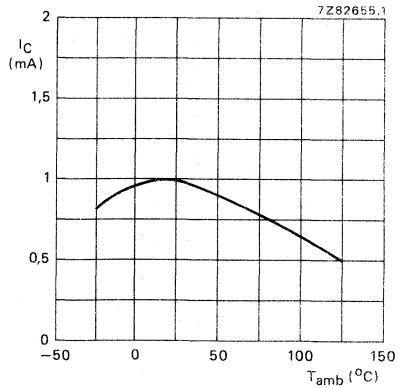

Fig. 20 $I_F = 2\text{ mA}$; typical values.

7282662

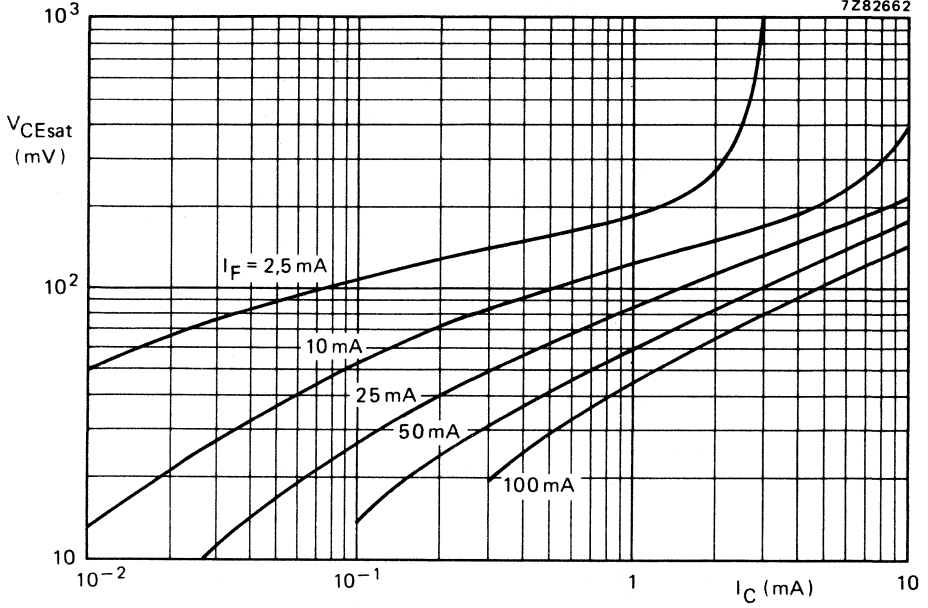

Fig. 21 $I_B = 0$; $T_{amb} = 25^\circ C$; typical values.

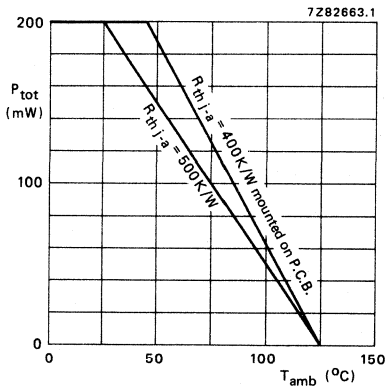

Fig. 22 Max. permissible power dissipation for total device versus ambient temperature.

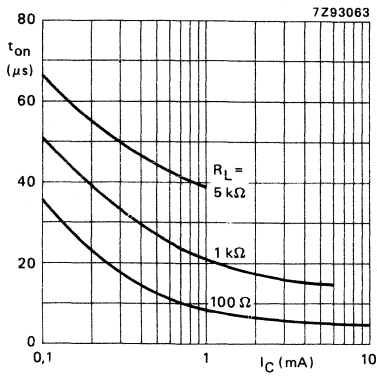

Fig. 23 $I_B = 0$; $V_{CC} = 5 V$; $T_{amb} = 25^\circ C$; typical values. (See also Fig. 25.)

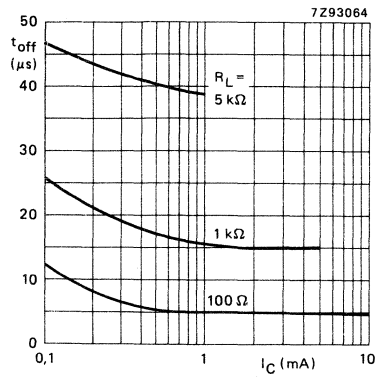

Fig. 24 $I_B = 0$; $V_{CC} = 5 V$; $T_{amb} = 25^\circ C$; typical values. (See also Fig. 25.)

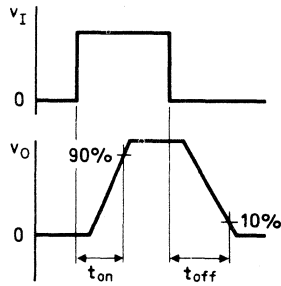
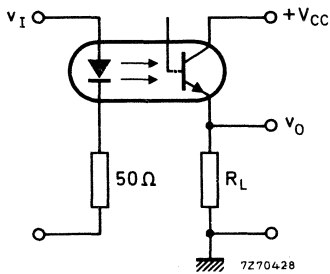

Fig. 25 Switching circuit and waveforms.

OPTOCOUPLER



Opto-isolator comprising an infrared emitting GaAs diode and a silicon n-p-n Darlington phototransistor with accessible base. Plastic 6-lead dual-in line (DIL) envelope.

Features:

- very high output/input d.c. current transfer ratio;
- high isolation voltage of 3,12 kV (r.m.s.) and 4,4 kV (d.c.);
- working voltage 2,5 kV (d.c.)

QUICK REFERENCE DATA

Diode

Continuous reverse voltage	V_R	max.	5 V
Forward current	I_F	max.	100 mA
d.c.	I_{FRM}	max.	3 A
(peak value); $t_p = 10 \mu s$; $\delta = 0,01$			
Total power dissipation up to $T_{amb} = 25 \text{ }^\circ\text{C}$	P_{tot}	max.	200 mW

Transistor

Collector-emitter voltage (open base)	V_{CEO}	max.	30 V
Total power dissipation up to $T_{amb} = 25 \text{ }^\circ\text{C}$	P_{tot}	max.	200 mW

Optocoupler

Output/input d.c. current transfer ratio (C.T.R.) $I_F = 1 \text{ mA}$; $V_{CE} = 1 \text{ V}$; ($I_B = 0$)	I_C/I_F	min.	5
Collector cut-off current (dark) $V_{CC} = 10 \text{ V}$; working voltage (d.c.) = 2,5 kV diode: $I_F = 0$ (see also Fig. 2)	I_{CEW}	max.	1 μA
Isolation voltage (d.c.)	V_{IORM}	min.	4,4 kV

MECHANICAL DATA

SOT-90B (see Fig. 1).

MECHANICAL DATA

Fig. 1 SOT-90B.

Dimensions in mm

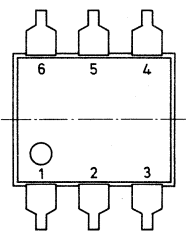
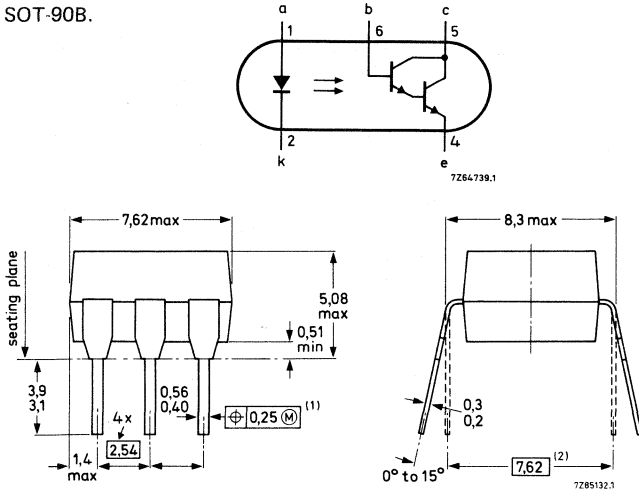

⊕ Positional accuracy.

Ⓜ Maximum material condition.

- (1) Centre-lines of all leads are within $\pm 0,125$ mm of the nominal position shown; in the worst case, the spacing between any two leads may deviate from nominal by 0,25 mm.
- (2) When the leads are parallel, the tips are in position for automatic insertion.

RATINGS

Limiting values in accordance with the Absolute Maximum System (IEC 134)

Diode

Continuous reverse voltage	V_R	max.	5 V
Forward current			
d.c.	I_F	max.	100 mA
(peak value); $t_p = 10 \mu s$; $\delta = 0,01$	I_{FRM}	max.	3 A
Total power dissipation up to $T_{amb} = 25 \text{ }^\circ\text{C}$	P_{tot}	max.	200 mW
Junction temperature	T_j	max.	125 $^\circ\text{C}$

Transistor

Collector-emitter breakdown voltage $I_C = 1 \text{ mA}$	$V_{(BR)CEO}$	min.	30 V
Collector-base breakdown voltage $I_C = 0,1 \text{ mA}$	$V_{(BR)CBO}$	min.	30 V
Emitter-collector breakdown voltage $I_E = 0,1 \text{ mA}$	$V_{(BR)ECO}$	min.	6 V
Collector current (d.c.)	I_C	max.	100 mA
Total power dissipation up to $T_{amb} = 25 \text{ }^\circ\text{C}$	P_{tot}	max.	200 mW
Junction temperature	T_j	max.	125 $^\circ\text{C}$

Optocoupler

Storage temperature	T_{stg}		-55 to +150 $^\circ\text{C}$
Lead soldering temperature up to the seating plane; $t_{sld} < 10 \text{ s}$	T_{sld}	max.	260 $^\circ\text{C}$

THERMAL RESISTANCE

From junction to ambient in free air diode and transistor	$R_{th j-a}$	=	500 K/W
From junction to ambient, device mounted on a printed-circuit board diode and transistor	$R_{th j-a}$	=	400 K/W

ISOLATION RELATED VALUES

External air gap (clearance) input terminals to output terminals	$L(I01)$	min.	7,2 mm
External tracking path (creepage dist) input terminals to output terminals	$L(I02)$	min.	7,0 mm
Tracking resistance (KB-value)			KB-100/A

CHARACTERISTICS

$T_j = 25 \text{ }^\circ\text{C}$ unless otherwise specified

Diode

Forward voltage $I_F = 10 \text{ mA}$	V_F	typ. max.	1,15 V 1,3 V
Reverse current $V_R = 5 \text{ V}$	I_R	max.	10 μA

Transistor ($I_F = 0$)

Collector cut-off current (dark) $V_{CE} = 10 \text{ V}$	I_{CEO}	typ. max.	20 nA 100 nA
$V_{CB} = 10 \text{ V}$	I_{CEO}	max.	20 nA
Collector-emitter breakdown voltage at $I_C = 1 \text{ mA}$	$V_{(BR)CEO}$	min.	30 V
Collector-base breakdown voltage at $I_C = 0,1 \text{ mA}$	$V_{(BR)CBO}$	min.	30 V

Emitter-collector breakdown voltage at $I_E = 0,1 \text{ mA}$	$V_{(BR)ECO}$	min.	7 V
Optocoupler ($I_B = 0$)*			
Output/input d.c. current transfer ratio (C.T.R.) $I_F = 0,5 \text{ mA}; V_{CE} = 1 \text{ V}$	I_C/I_F	min.	3,5
$I_F = 1,0 \text{ mA}; V_{CE} = 1 \text{ V}$	I_C/I_F	min.	5
$I_F = 10 \text{ mA}; V_{CE} = 1 \text{ V}$	I_C/I_F	min.	6
Collector cut-off current (dark) see Fig. 2 $V_{CC} = 10 \text{ V};$ working voltage (d.c.) = 2,5 kV	I_{CEW}	max.	1 μA^{**}
$V_{CC} = 10 \text{ V};$ working voltage (d.c.) = 2,5 kV; $T_j = 70 \text{ }^\circ\text{C}$	I_{CEW}	max.	1000 μA^{**}
Collector-emitter saturation voltage $I_F = 5 \text{ mA}; I_C = 10 \text{ mA}$	V_{CEsat}	max.	1 V
Isolation voltage \blacktriangle	V_{IORM}	min.	4,4 kV (d.c.) 3,12 kV (r.m.s.)
Collector capacitance at $f = 1 \text{ MHz}$ $I_E = I_e = 0; V_{CB} = 10 \text{ V}$	C_{bc}	typ.	4,5 pF
Capacitance between input and output $I_F = 0; V = 0; f = 1 \text{ MHz}$	C_{io}	typ.	0,6 pF
Insulation resistance between input and output $\pm V_{IO} = 1 \text{ kV}$	r_{IO}	min.	$10^{10} \Omega$
		typ.	$10^{12} \Omega$
Switching times (see Figs 3 and 4)	t_{on}	typ.	5 μs
$I_{Fon} = 10 \text{ mA}; V_{CC} = 5 \text{ V}; R_E = 100 \Omega; R_{BE} = 1 \text{ M}\Omega$	t_{off}	typ.	30 μs
	t_{on}	typ.	50 μs
$I_{Fon} = 1 \text{ mA}; V_{CC} = 5 \text{ V}; R_E = 1 \text{ k}\Omega; R_{BE} = 10 \text{ M}\Omega$	t_{off}	typ.	250 μs

* Where the phototransistor receives light from the diode the O (for open base) has been omitted from the symbols.

** As quality assurance (on a sample basis), these parameters are covered by a 1000 h reliability test.

\blacktriangle Tested on a sample basis with a voltage of 4400 V (d.c.) for 1 minute between the shorted input (diode) leads and the shorted output (phototransistor) leads.

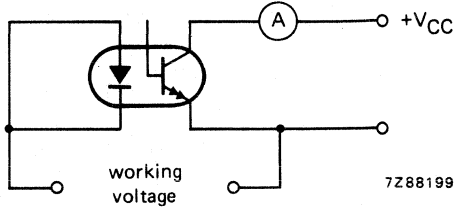

7Z88199

Fig. 2.

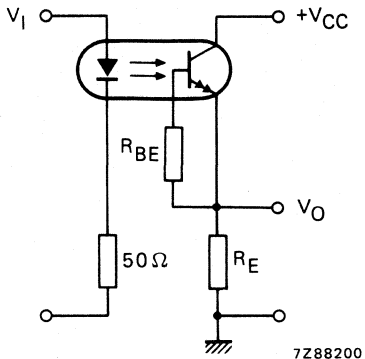

7Z88200

Fig. 3 Switching circuit.

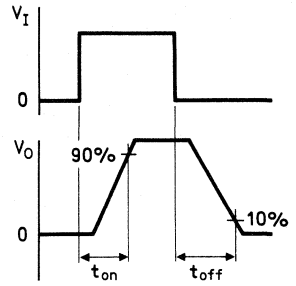

7Z67238.2

Fig. 4 Waveforms.

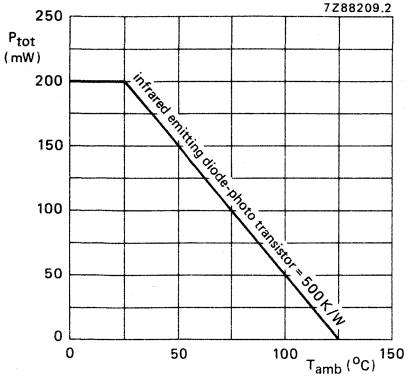

Fig. 5 Power derating curve for diode and transistor as a function of temperature.

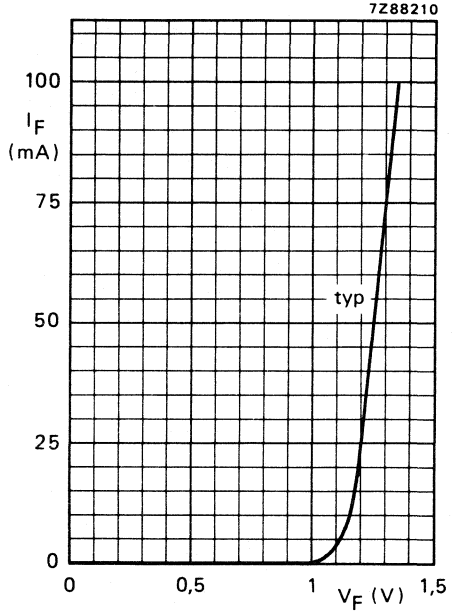

Fig. 6 $T_{amb} = 25$ °C.

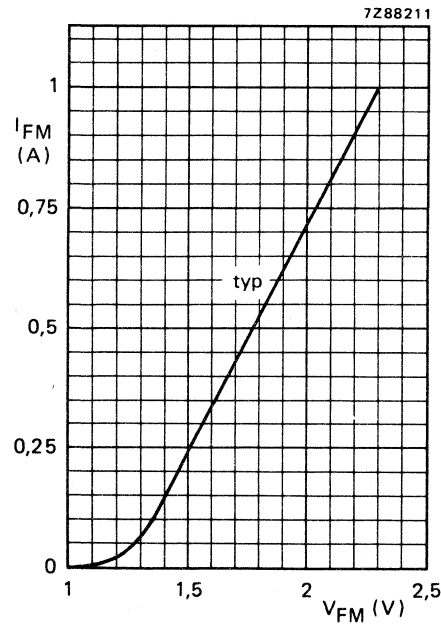

Fig. 7 $T_{amb} = 25$ °C; $t_p = 10 \mu s$; $\delta = 0,01$.

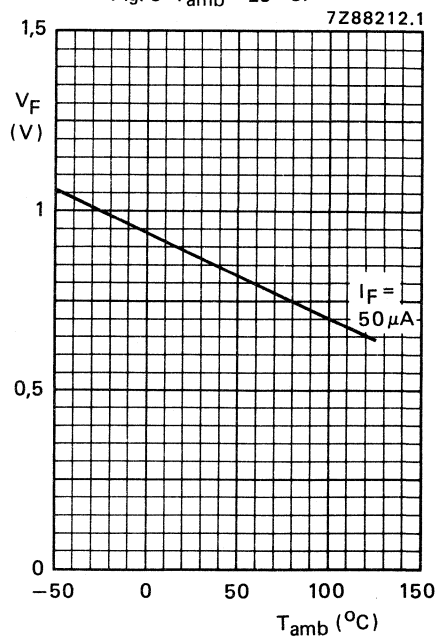

Fig. 8 Typical values.

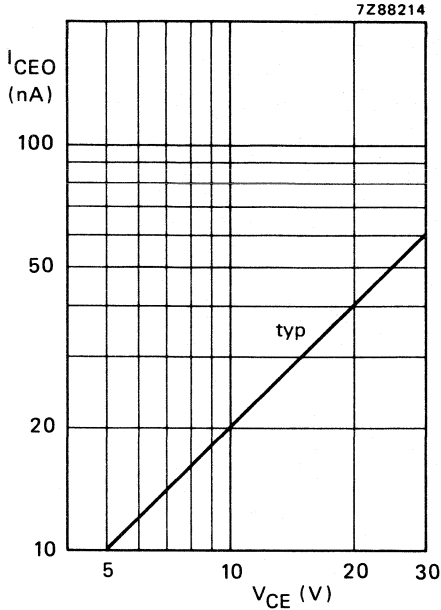

Fig. 9 $I_F = 0$; $T_j = 25^\circ\text{C}$.

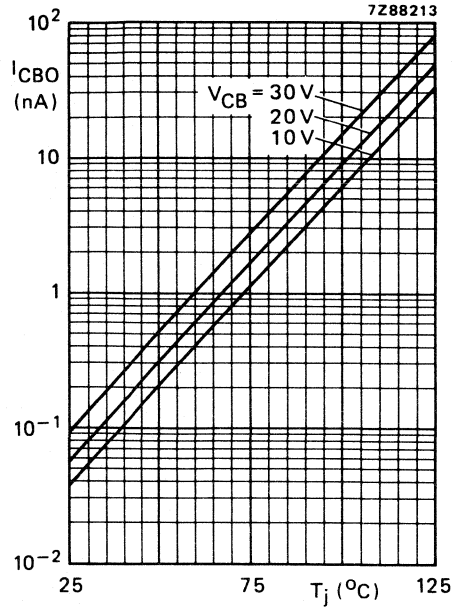

Fig. 10 Typical values.

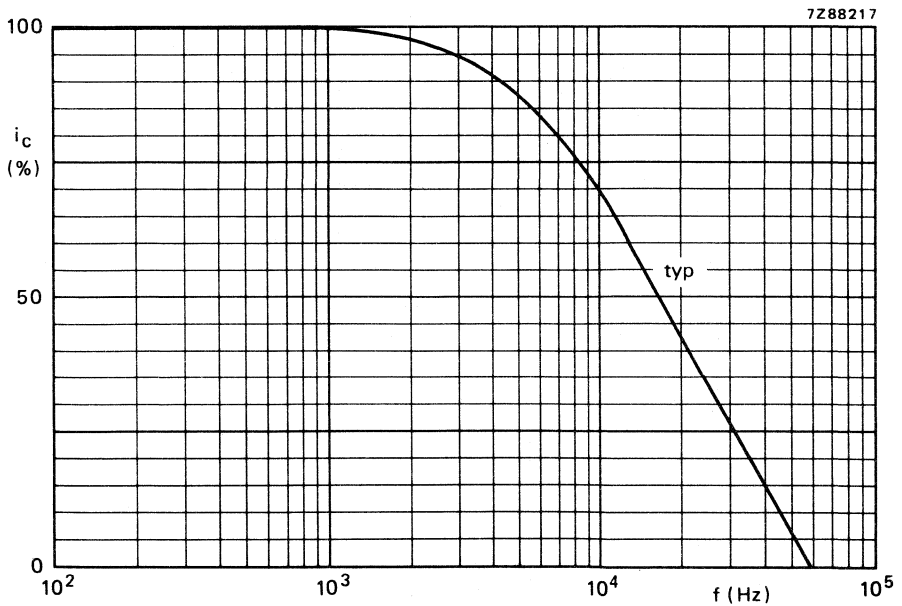

Fig. 11 $I_C = 10\text{ mA}$; $V_{CC} = 5\text{ V}$; $R_E = 100\ \Omega$; $R_{BE} = 1\text{ M}\Omega$; see also Fig. 4.

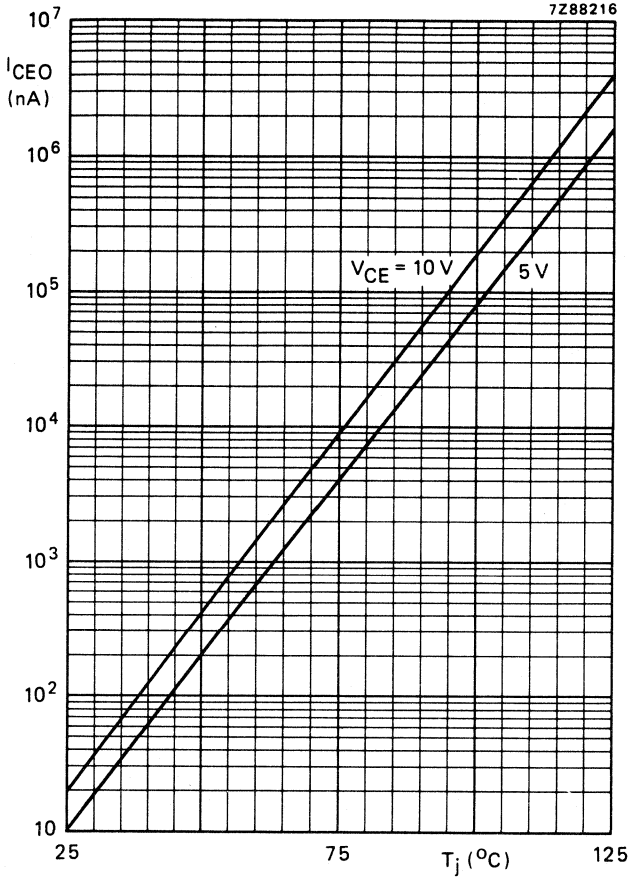

Fig. 12 $I_F = 0$; typical values.

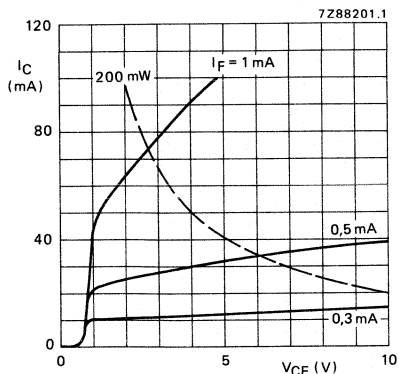

Fig. 13 Typical values; $T_{amb} = 25^\circ C$.

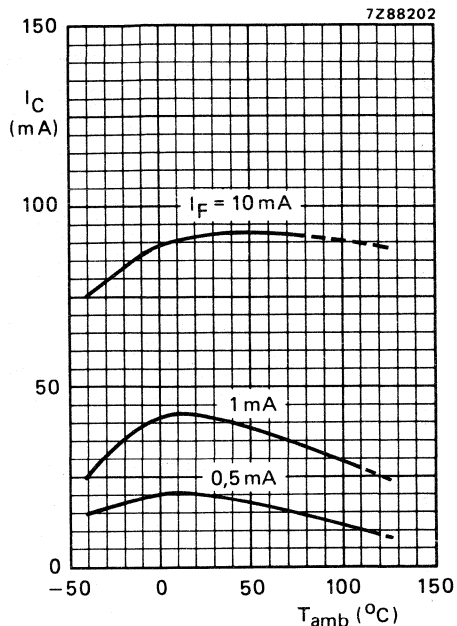

Fig. 14 Typical values; $I_B = 0$; $V_{CE} = 1$ V.

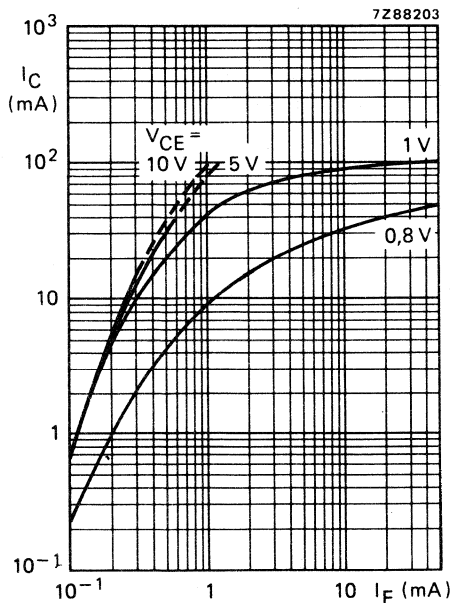

Fig. 15 Typical values; $I_B = 0$; $T_{amb} = 25^\circ C$.

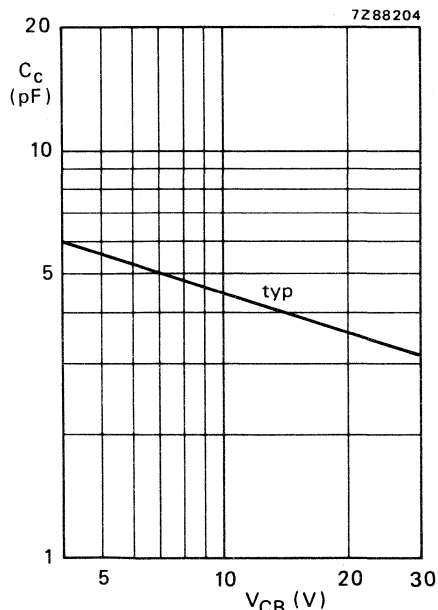

Fig. 16 $I_E = I_e = 0$; $f = 1$ MHz; $T_{amb} = 25^\circ C$.

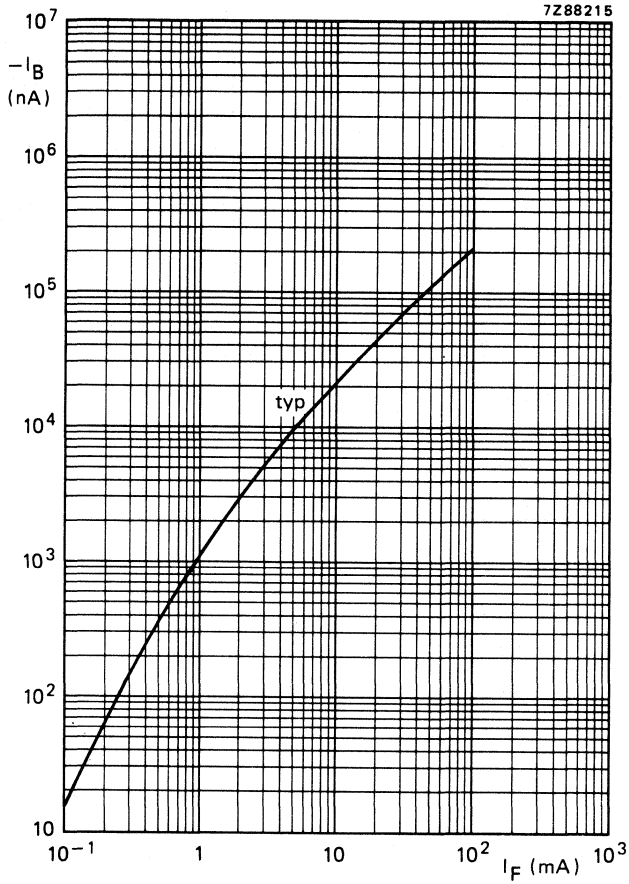

Fig. 17 $I_E = 0$; $V_{CB} = 5$ V; $T_{amb} = 25$ °C.

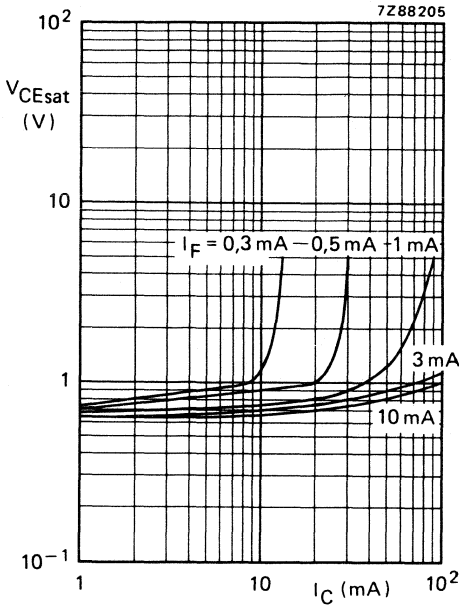

Fig. 18 Typical values; $I_B = 0$; $T_{amb} = 25^\circ C$.

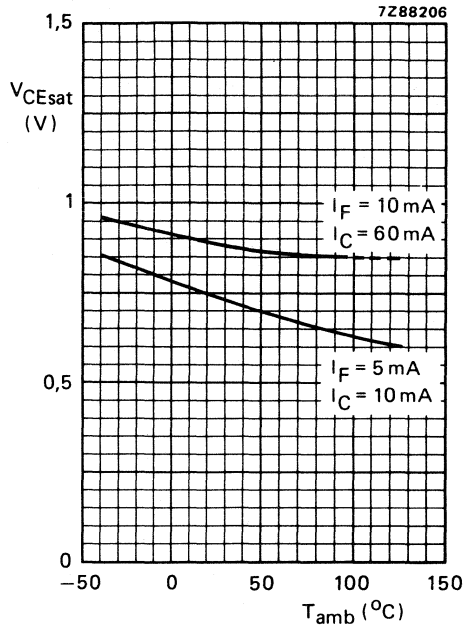

Fig. 19 Typical values; $I_B = 0$.

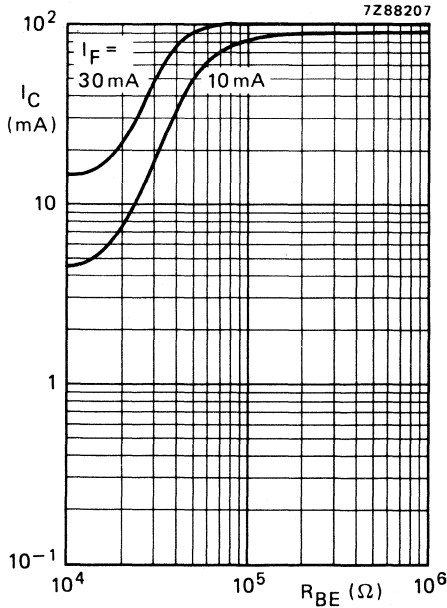

Fig. 20 Typ. values; $V_{CE} = 1$ V; $T_{amb} = 25^\circ C$.

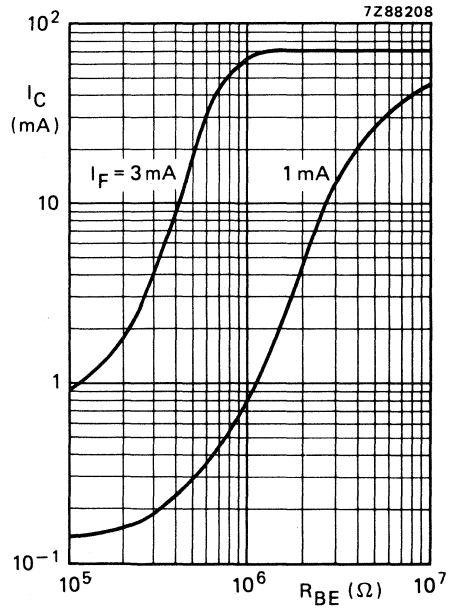

Fig. 21 Typ. values; $V_{CE} = 1$ V; $T_{amb} = 25^\circ C$.

OPTOCOUPLER



Opto-isolator comprising an infrared emitting GaAs diode and a silicon n-p-n Darlington phototransistor with accessible base. Plastic 6-lead dual-in line (DIL) envelope.

Features:

- very high output/input d.c. current transfer ratio;
- high isolation voltage of 3,12 (r.m.s.) and 4,4 kV (d.c.)
- working voltage 2,5 kV (d.c.)

UL — Covered under UL component recognition FILE E90700

VDE — Approved according to VDE 0883/6.83

Complied for reinforced isolation at 250 VAC with:

DIN 57 804/VDE 0804/1.83 (isolation group C)

DIN IEC 65/VDE 0860/8.81

QUICK REFERENCE DATA

Diode

Continuous reverse voltage	V_R	max.	5 V
Forward current			
d.c.	I_F	max.	100 mA
(peak value); $t_p = 10 \mu s$; $\delta = 0,01$	I_{FRM}	max.	3 A
Total power dissipation up to $T_{amb} = 25^\circ C$	P_{tot}	max.	200 mW

Transistor

Collector-emitter voltage (open base)	V_{CEO}	max.	30 V
Total power dissipation up to $T_{amb} = 25^\circ C$	P_{tot}	max.	200 mW

Optocoupler

Output/input d.c. current transfer ratio (C.T.R.)

$I_F = 1 \text{ mA}$; $V_{CE} = 1 \text{ V}$; ($I_B = 0$)

I_C/I_F min. 5

Collector cut-off current (dark)

$V_{CC} = 10 \text{ V}$; working voltage (d.c.) = 1,5 kV

diode: $I_F = 0$ (see also Fig. 2)

I_{CEW} max. 1 μA

Isolation voltage (d.c.)

V_{IORM} min. 4,4 kV

MECHANICAL DATA

SOT-90B (see Fig. 1).

MECHANICAL DATA

Fig. 1 SOT-90B.

Dimensions in mm

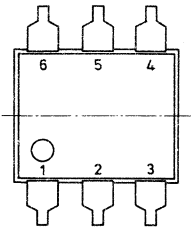
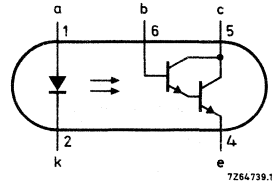
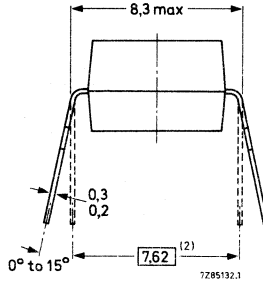
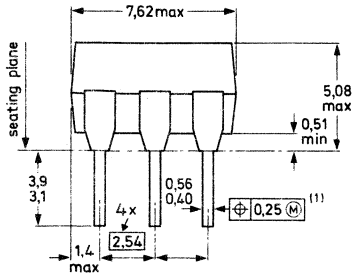

⊕ Positional accuracy.

(M) Maximum material condition.

- (1) Centre-lines of all leads are within $\pm 0,125$ mm of the nominal position shown; in the worst case, the spacing between any two leads may deviate from nominal by 0,25 mm.
- (2) When the leads are parallel, the tips are in position for automatic insertion.

RATINGS

Limiting values in accordance with the Absolute Maximum System (IEC 134)

Diode

Continuous reverse voltage	V_R	max.	5 V
Forward current	I_F	max.	100 mA
d.c.	I_{FRM}	max.	3 A
(peak value); $t_p = 10 \mu s$; $\delta = 0,01$	P_{tot}	max.	200 mW
Total power dissipation up to $T_{amb} = 25 \text{ }^\circ\text{C}$	T_j	max.	125 $^\circ\text{C}$
Junction temperature			

Transistor

Collector-emitter breakdown voltage

$I_C = 1 \text{ mA}$

V(BR)CEO min. 30 V

Collector-base breakdown voltage

$I_C = 0,1 \text{ mA}$

V(BR)CBO min. 30 V

Emitter-collector breakdown voltage

$I_E = 0,1 \text{ mA}$

V(BR)ECO min. 6 V

Collector current (d.c.)

 I_C max. 100 mATotal power dissipation up to $T_{amb} = 25 \text{ }^\circ\text{C}$ P_{tot} max. 200 mW

Junction temperature

 T_j max. 125 $^\circ\text{C}$ **Optocoupler**

Storage temperature

 T_{stg} -55 to +150 $^\circ\text{C}$

Lead soldering temperature

up to the seating plane; $t_{sld} < 10 \text{ s}$ T_{sld} max. 260 $^\circ\text{C}$ **THERMAL RESISTANCE**From junction to ambient in free air
diode and transistor $R_{th \text{ j-a}}$ = 500 K/WFrom junction to ambient, device
mounted on a printed-circuit board
diode and transistor $R_{th \text{ j-a}}$ = 400 K/W**ISOLATION RELATED VALUES**

External air gap (clearance)

input terminals to output terminals

L(I01) min. 7,2 mm

External tracking path (creepage dist)

input terminals to output terminals

L(I02) min. 7,0 mm

Tracking resistance (KB-value)

KB-100/A

CHARACTERISTICS $T_j = 25 \text{ }^\circ\text{C}$ unless otherwise specified**Diode**

Forward voltage

$I_F = 10 \text{ mA}$

 V_F typ. 1,15 V
max. 1,3 V

Reverse current

$V_R = 5 \text{ V}$

 I_R max. 10 μA **Transistor ($I_F = 0$)**

Collector cut-off current (dark)

$V_{CE} = 10 \text{ V}$

 I_{CEO} typ. 20 nA
max. 100 nA

$V_{CB} = 10 \text{ V}$

 I_{CEO} max. 20 nA

Collector-emitter breakdown voltage

at $I_C = 1 \text{ mA}$

V(BR)CEO min. 30 V

Collector-base breakdown voltage

at $I_C = 0,1 \text{ mA}$

V(BR)CBO min. 30 V

Emitter-collector breakdown voltage
at $I_E = 0,1 \text{ mA}$

$V_{(BR)ECO}$ min. 7 V

Optocoupler ($I_B = 0$)*

Output/input d.c. current transfer ratio (C.T.R.)

$I_F = 0,5 \text{ mA}; V_{CE} = 1 \text{ V}$

$I_F = 1,0 \text{ mA}; V_{CE} = 1 \text{ V}$

$I_F = 10 \text{ mA}; V_{CE} = 1 \text{ V}$

I_C/I_F	min.	3,5
I_C/I_F	min.	5
I_C/I_F	min.	6

Collector cut-off current (dark) see Fig. 2

$V_{CC} = 10 \text{ V};$ working voltage (d.c.) = 1,5 kV

$V_{CC} = 10 \text{ V};$ working voltage (d.c.) = 1,5 kV; $T_j = 70 \text{ }^\circ\text{C}$

I_{CEW}	max.	1 μA **
I_{CEW}	max.	1000 μA **

Collector-emitter saturation voltage

$I_F = 5 \text{ mA}; I_C = 10 \text{ mA}$

V_{CEsat}	max.	1 V
-------------	------	-----

→ Isolation voltage ▼

V_{IORM}	min.	4,4 kV(d.c.) 3,12 kV(r.m.s.)
------------	------	---------------------------------

Collector capacitance at $f = 1 \text{ MHz}$

$I_E = I_e = 0; V_{CB} = 10 \text{ V}$

C_{bc}	typ.	4,5 pF
----------	------	--------

Capacitance between input and output

$I_F = 0; V = 0; f = 1 \text{ MHz}$

C_{io}	typ.	0,6 pF
----------	------	--------

Insulation resistance between input and output

$\pm V_{IO} = 1 \text{ kV}$

r_{IO}	min.	$10^{10} \Omega$
	typ.	$10^{12} \Omega$

Switching times (see Figs 3 and 4)

$I_{Fon} = 10 \text{ mA}; V_{CC} = 5 \text{ V}; R_E = 100 \Omega; R_{BE} = 1 \text{ M}\Omega$

t_{on}	typ.	5 μs
t_{off}	typ.	30 μs

$I_{Fon} = 1 \text{ mA}; V_{CC} = 5 \text{ V}; R_E = 1 \text{ k}\Omega; R_{BE} = 10 \text{ M}\Omega$

t_{on}	typ.	50 μs
t_{off}	typ.	250 μs

* Where the phototransistor receives light from the diode the O (for open base) has been omitted from the symbols.

** As quality assurance (on a sample basis), these parameters are covered by a 1000 h reliability test.

▲ Every single product is tested by applying an isolation test voltage of 3750 V (r.m.s.) for 2 seconds between the shorted input (diode) leads and the shorted output (phototransistor) leads.

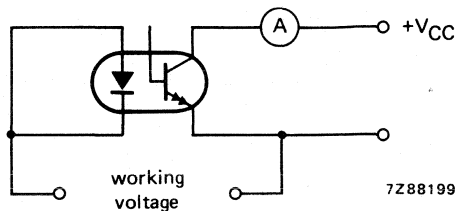

7Z88199

Fig. 2.

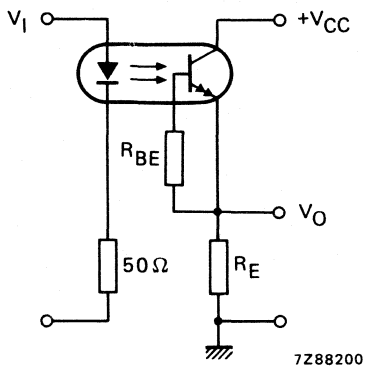

7Z88200

Fig. 3 Switching circuit.

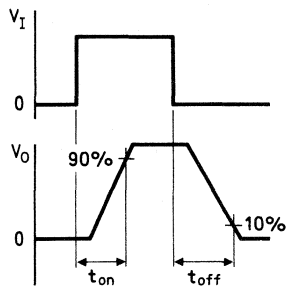

7Z67238.2

Fig. 4 Waveforms.

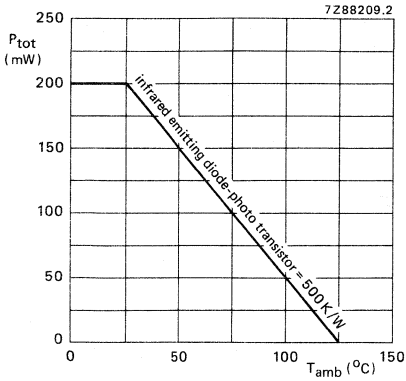

Fig. 5 Power derating curve for diode and transistor as a function of temperature.

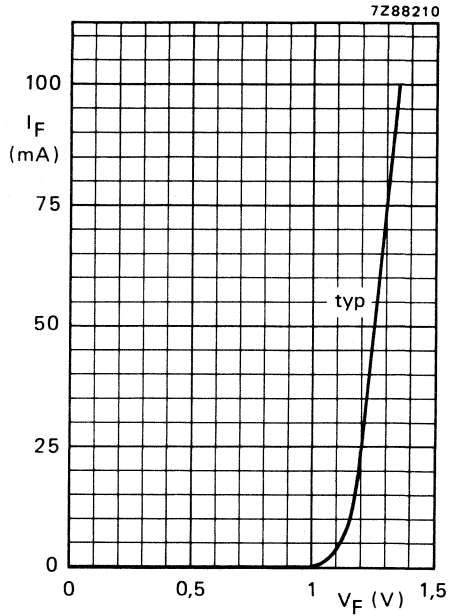

Fig. 6 $T_{amb} = 25\text{ }^{\circ}\text{C}$.

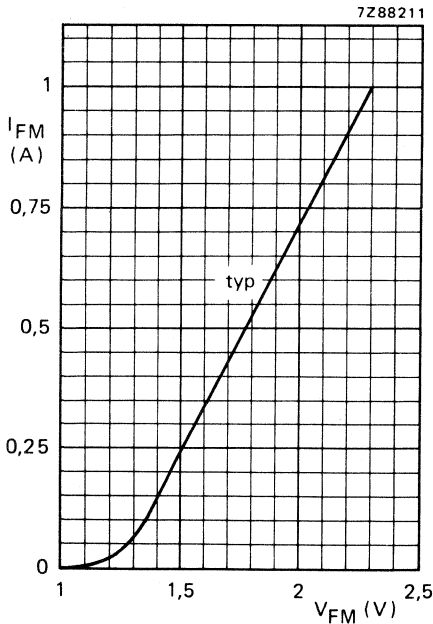

Fig. 7 $T_{amb} = 25\text{ }^{\circ}\text{C}$; $t_D = 10\text{ }\mu\text{s}$; $\delta = 0,01$.

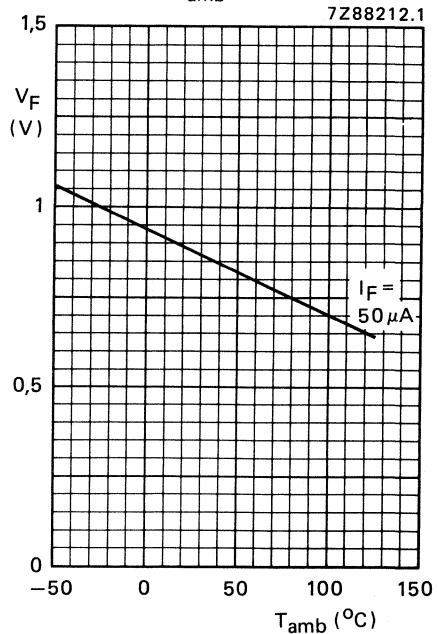

Fig. 8 Typical values.

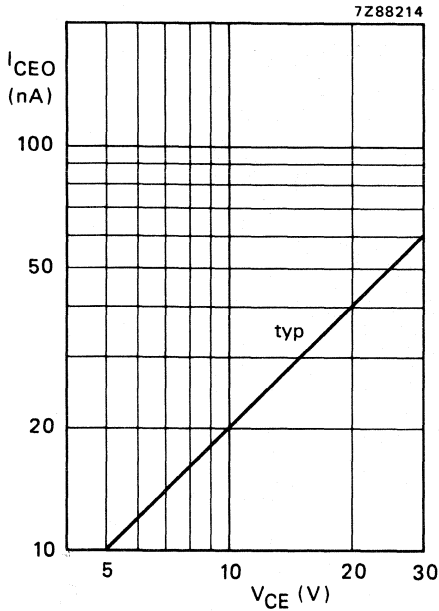

Fig. 9 $I_F = 0$; $T_j = 25^\circ\text{C}$.

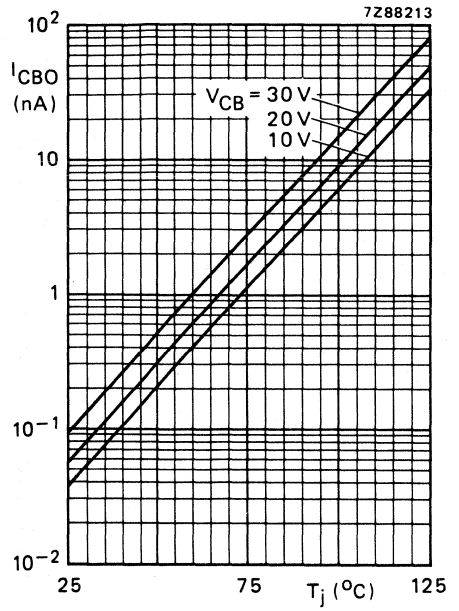

Fig. 10 Typical values.

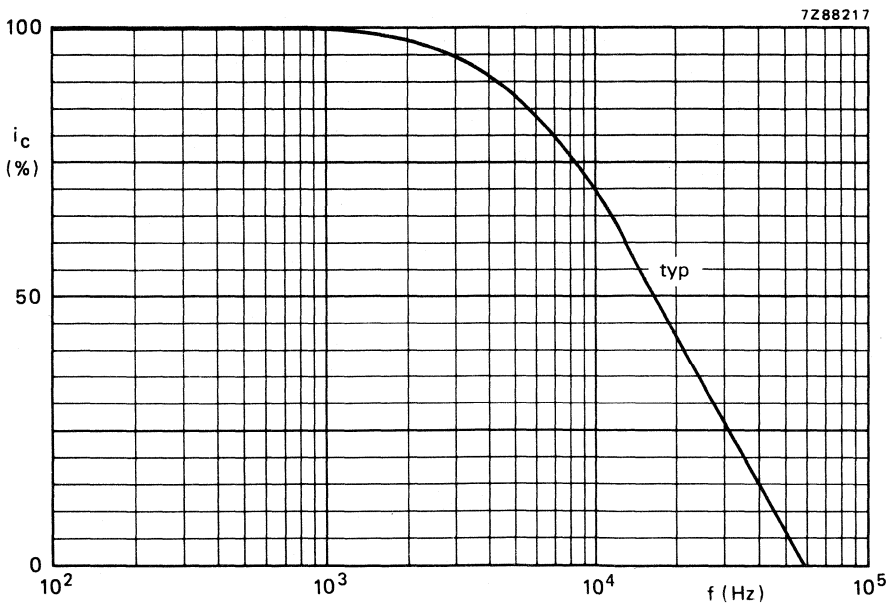

Fig. 11 $I_C = 10\text{ mA}$; $V_{CC} = 5\text{ V}$; $R_E = 100\ \Omega$; $R_{BE} = 1\text{ M}\Omega$; see also Fig. 3.

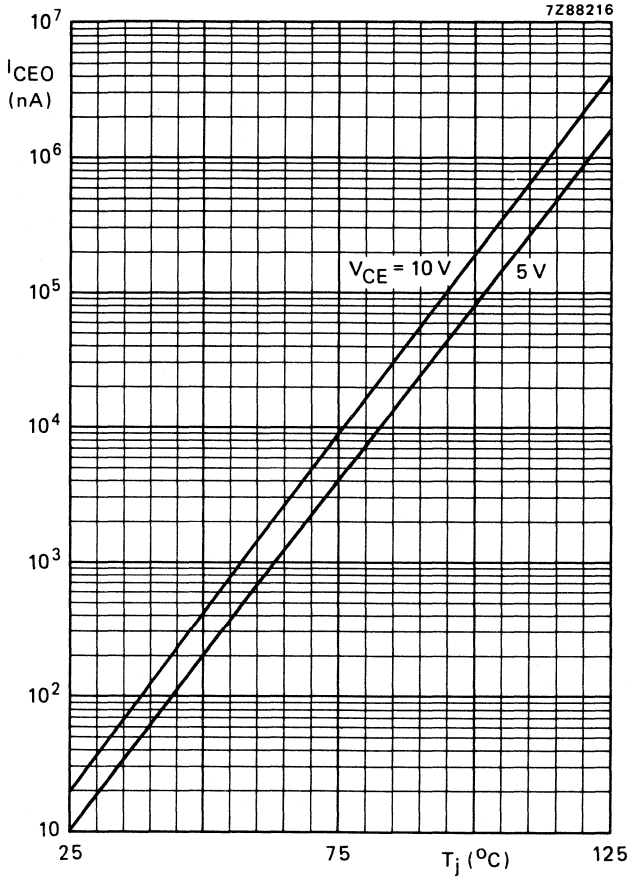

Fig. 12 $I_F = 0$; typical values.

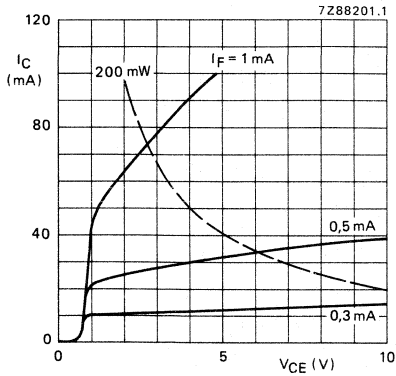

Fig. 13 Typical values; $T_{amb} = 25\text{ }^\circ\text{C}$.

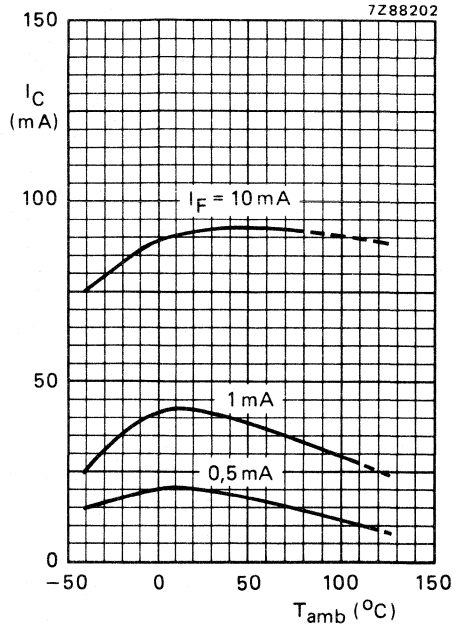

Fig. 14 Typical values; $I_B = 0$; $V_{CE} = 1\text{ V}$.

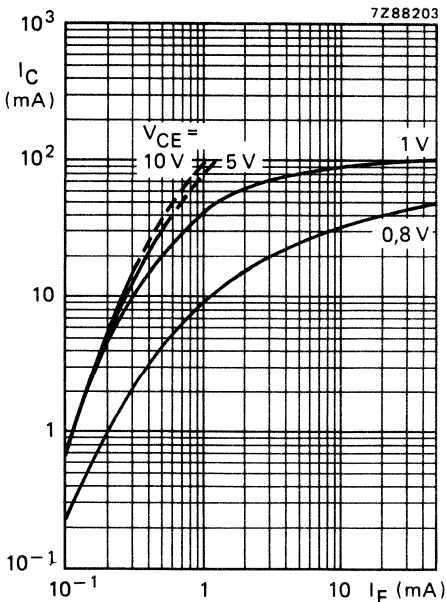

Fig. 15 Typical values; $I_B = 0$; $T_{amb} = 25\text{ }^\circ\text{C}$.

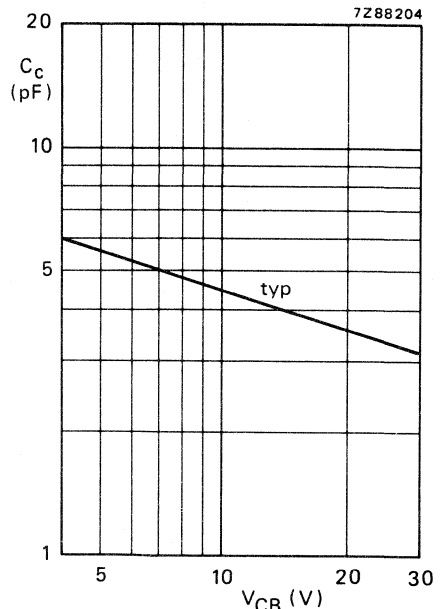

Fig. 16 $I_E = I_e = 0$; $f = 1\text{ MHz}$; $T_{amb} = 25\text{ }^\circ\text{C}$.

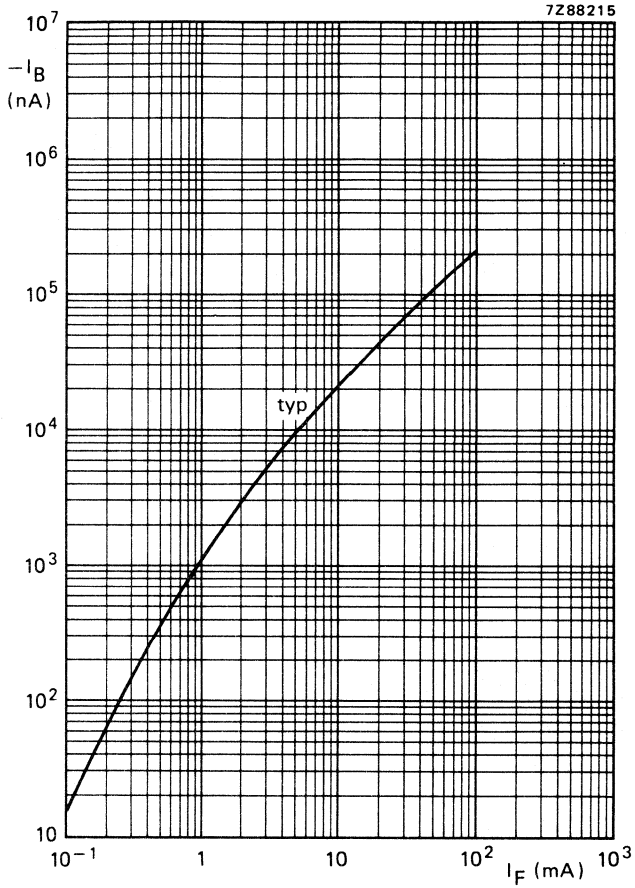

Fig. 17 $I_E = 0$; $V_{CB} = 5$ V; $T_{amb} = 25$ °C.

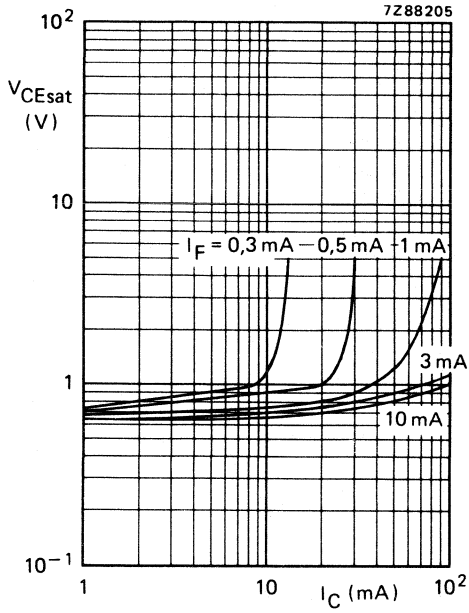

Fig. 18 Typical values; $I_B = 0$; $T_{amb} = 25^\circ C$.

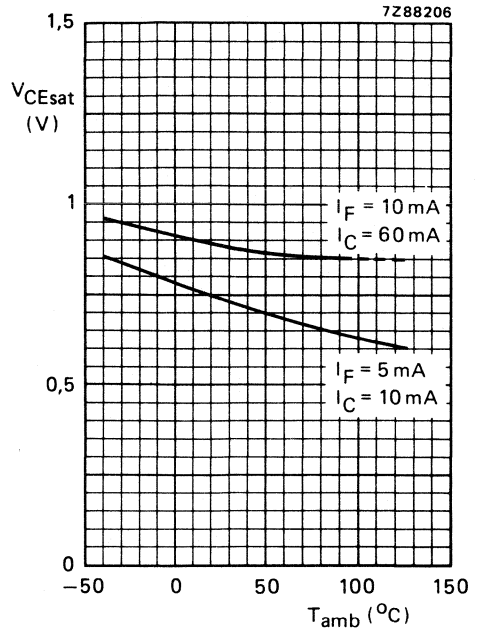

Fig. 19 Typical values; $I_B = 0$.

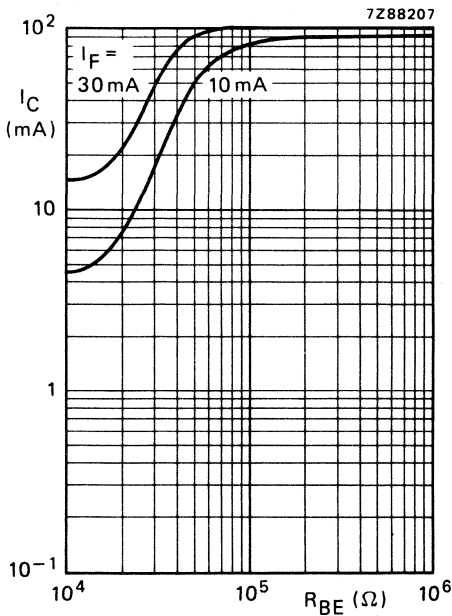

Fig. 20 Typ. values; $V_{CE} = 1$ V; $T_{amb} = 25^\circ C$.

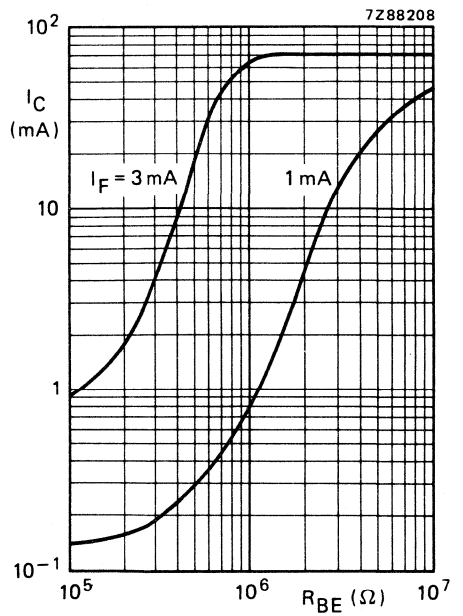

Fig. 21 Typ. values; $V_{CE} = 1$ V; $T_{amb} = 25^\circ C$.

HIGH-VOLTAGE OPTOCOUPLER

The CNX62 is an optocoupler consisting of an infrared emitting GaAs diode and a silicon n-p-n photo-transistor in a dual-in-line (DIL) plastic envelope. The base is not connected.

Features

- high current transfer ratio and a low saturation voltage suitable for use with TTL integrated circuits
- high degree of a.c. and d.c. insulation (3750 V r.m.s. and 5300 V d.c.)
- working voltage of 2,5 kV (d.c.)

UL — Covered under UL component recognition FILE E90700

VDE — Approved according to VDE 0883/6.83

Complied for reinforced isolation at 250 VAC with:

DIN 57 804/VDE 0804/1.83 (isolation group C)

DIN IEC 65/VDE 0860/8.81

QUICK REFERENCE DATA**Diode**

Continuous reverse voltage	V_R	max.	5 V
Forward current	I_F	max.	100 mA
d.c.	I_{FRM}	max.	3 A
peak value; $t_{ON} = 10 \mu s$; $\delta = 0,01$	P_{tot}	max.	200 mW
Total power dissipation up to $T_{amb} = 25 \text{ }^\circ\text{C}$			

Transistor

Collector-emitter voltage (open base)	V_{CEO}	max.	50 V
Total power dissipation up to $T_{amb} = 25 \text{ }^\circ\text{C}$	P_{tot}	max.	200 mW

Optocoupler

Output/input d.c. current transfer ratio (C.T.R.)	I_C/I_F	min.	0,4
$I_F = 10 \text{ mA}$; $V_{CE} = 0,4 \text{ V}$			
Collector cut-off current (dark)	I_{CEW}	max.	200 nA
$V_{CC} = 10 \text{ V}$; working voltage (d.c.) = 2,5 kV			
I_F (diode) = 0 (see Fig. 4)			
Collector-emitter saturation voltage	V_{CEsat}	max.	0,4 V
$I_F = 10 \text{ mA}$; $I_C = 4 \text{ mA}$	V_{IORM}	min.	5,3 kV
Isolation voltage (d.c.)			

MECHANICAL DATA

SOT-174 (see Fig. 1).

MECHANICAL DATA

Fig. 1 SOT-174.

Dimensions in mm

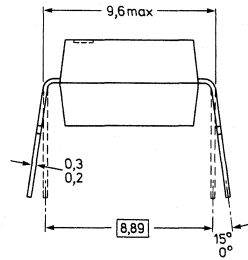
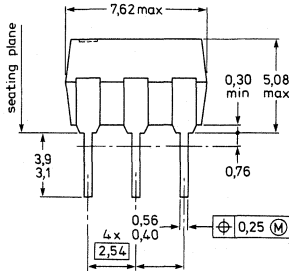

7Z85851A

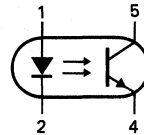
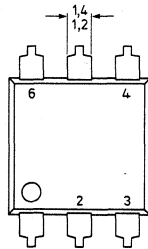

The base is not connected.

RATINGS

→ Limiting values in accordance with the Absolute Maximum System (IEC 134)

Diode

Continuous reverse voltage	V_R	max.	5 V
Forward current	I_F	max.	100 mA
d.c.	I_{FRM}	max.	3 A
peak value; $t_{on} = 10 \mu s$; $\delta = 0,01$			
Total power dissipation up to $T_{amb} = 25 \text{ }^\circ\text{C}$ (when mounted on a printed circuit board: $T_{amb} = 45 \text{ }^\circ\text{C}$)	P_{tot}	max.	200 mW

Transistor

Collector-emitter voltage (open base)	V_{CEO}	max.	50 V
Emitter-collector voltage	V_{ECO}	max.	7 V
Collector current (d.c.)	I_C	max.	100 mA
Total power dissipation up to $T_{amb} = 25 \text{ }^\circ\text{C}$ (when mounted on a printed circuit board: $T_{amb} = 45 \text{ }^\circ\text{C}$)	P_{tot}	max.	200 mW

Optocoupler

Storage temperature	T_{stg}	-55 to +150 °C
Junction temperature	T_j	max. 125 °C
Soldering temperature up to the seating plane; $t_{sld} < 10$ s	T_{sld}	max. 260 °C

THERMAL RESISTANCE

From junction to ambient in free air			
diode	$R_{th\ j-a}$	max.	500 K/W
transistor	$R_{th\ j-a}$	max.	500 K/W
From junction to ambient when mounted on p.c.b.			
diode	$R_{th\ j-a}$	max.	400 K/W
transistor	$R_{th\ j-a}$	max.	400 K/W

ISOLATION RELATED VALUES

External air gap (clearance) input terminals to output terminals	$L(I01)$	min.	8,4 mm
External tracking path (creepage dist) input terminals to output terminals	$L(I02)$	min.	7,0 mm
Tracking resistance (KB-value)			KB-100/A

CHARACTERISTICS

$T_j = 25$ °C unless otherwise specified

Diode

Forward voltage $I_F = 10$ mA	V_F	typ. max.	1,15 V 1,50 V
Reverse current $V_R = 5$ V	I_R	max.	10 μ A

Transistor

Collector-emitter breakdown voltage $I_C = 1$ mA	$V(BR)_{CEO}$	min.	50 V
Emitter-collector breakdown voltage $I_E = 0,1$ mA	$V(BR)_{ECO}$	min.	7 V
Collector cut-off current (dark); diode $I_F = 0$ $V_{CE} = 10$ V	I_{CEO}	typ. max.	2 nA 50 nA
$V_{CE} = 10$ V; $T_{amb} = 70$ °C	I_{CEO}	max.	10 μ A

Optocoupler

Output/input d.c. current transfer ratio (C.T.R.) $I_F = 10$ mA; $V_{CE} = 0,4$ V	I_C/I_F	min. typ.	0,4 0,8
$I_F = 10$ mA; $V_{CE} = 5$ V	I_C/I_F	typ.	1,5
Collector cut-off current (light) $T_{amb} \leq 70$ °C; $V_F = 0,8$ V; $V_{CE} = 15$ V	$I_{CE(L)}$	max.	15 μ A
$T_{amb} \leq 70$ °C; $I_F = 2$ mA; $V_{CE} = 0,4$ V	$I_{CE(L)}$	min.	150 μ A

→ **Optocoupler** (continued)

Collector-emitter saturation voltage

$I_F = 10 \text{ mA}; I_C = 4 \text{ mA}$

V_{CEsat}	typ.	0,19 V
	max.	0,40 V

Collector cut-off current (dark) at working voltage (2,5 kV d.c.);

$V_{CC} = 10 \text{ V}; T_J = 25 \text{ }^\circ\text{C}$ (see Fig. 4)

$V_{CC} = 10 \text{ V}; T_J = 70 \text{ }^\circ\text{C}$ (see Fig. 4)

I_{CEW}	max.	200 nA*
	max.	100 μA *

Isolation voltage
(see note 1)

V_{IORM}	min.	5,3 kV(d.c.)
		3,75 kV(r.m.s.)

Capacitance between input and output

$V = 0; f = 1 \text{ MHz}$

C_{io}	typ.	0,6 pF
----------	------	--------

Insulation resistance between input and output

$V_{IO} = \pm 1000 \text{ V}$

R_{IO}	min.	$10^{10} \Omega$
	typ.	$10^{12} \Omega$

Switching times (see Figs 2 and 3)

Turn-on time

$I_C = 2 \text{ mA}; V_{CC} = 5 \text{ V}; R_L = 100 \Omega$

$I_C = 2 \text{ mA}; V_{CC} = 5 \text{ V}; R_L = 1 \text{ k}\Omega$

t_{on}	typ.	3 μs
	typ.	12 μs

Turn-off time

$I_C = 2 \text{ mA}; V_{CC} = 5 \text{ V}; R_L = 100 \Omega$

$I_C = 2 \text{ mA}; V_{CC} = 5 \text{ V}; R_L = 1 \text{ k}\Omega$

t_{off}	typ.	3 μs
	typ.	12 μs

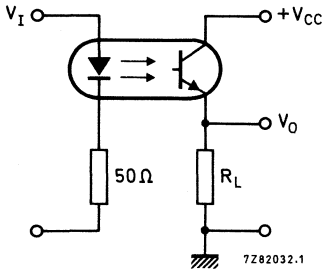

Fig. 2 Switching circuit.

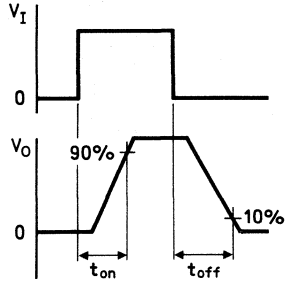

Fig. 3 Waveforms.

* The two parameters are tested on a sample basis for 1000 h.

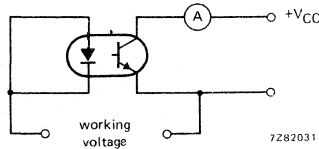

Fig. 4.

Note 1:

Every single product is tested by applying an isolation test voltage of 4500 V (r.m.s.) for 2 seconds between the shorted input (diode) leads and the shorted output (phototransistor) leads.

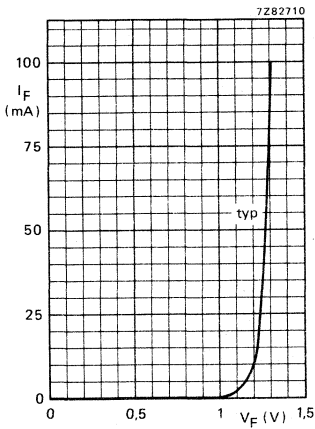

Fig. 5 $T_{amb} = 25\text{ }^\circ\text{C}$.

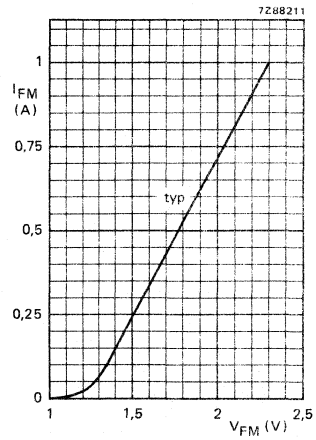

Fig. 6 $T_{amb} = 25\text{ }^\circ\text{C}$; $t_p = 10\text{ }\mu\text{s}$; $\delta = 0,01$.

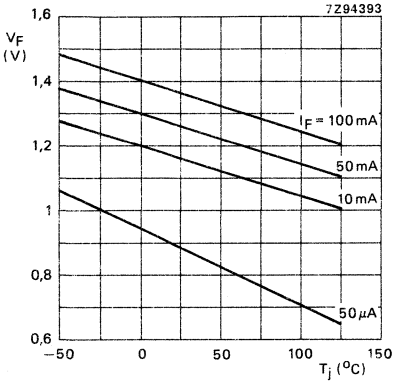

Fig. 7 Typical values.

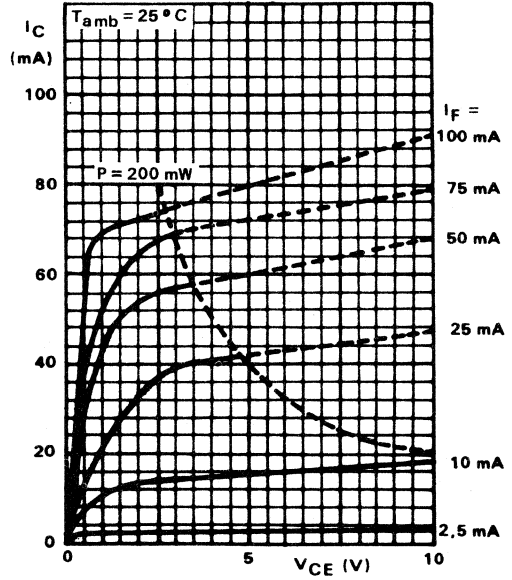

Fig. 8 Typical values.

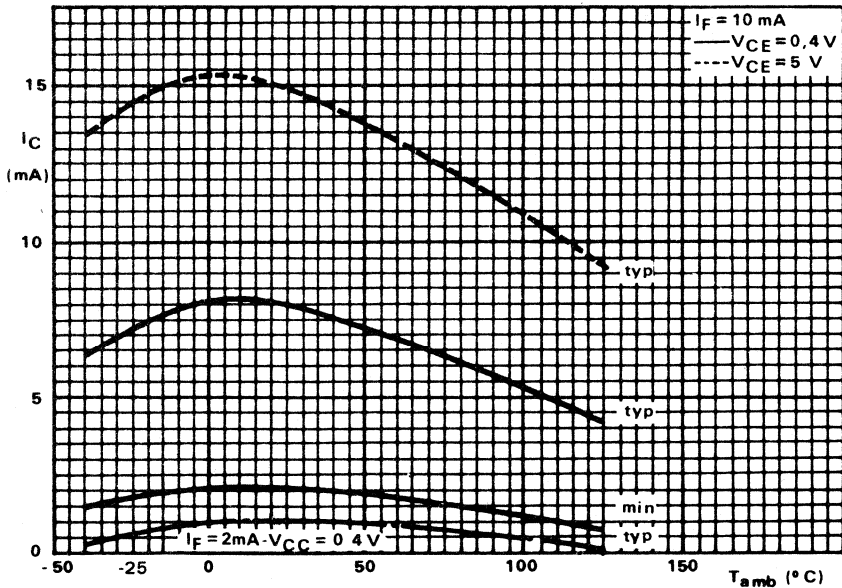

Fig. 9.

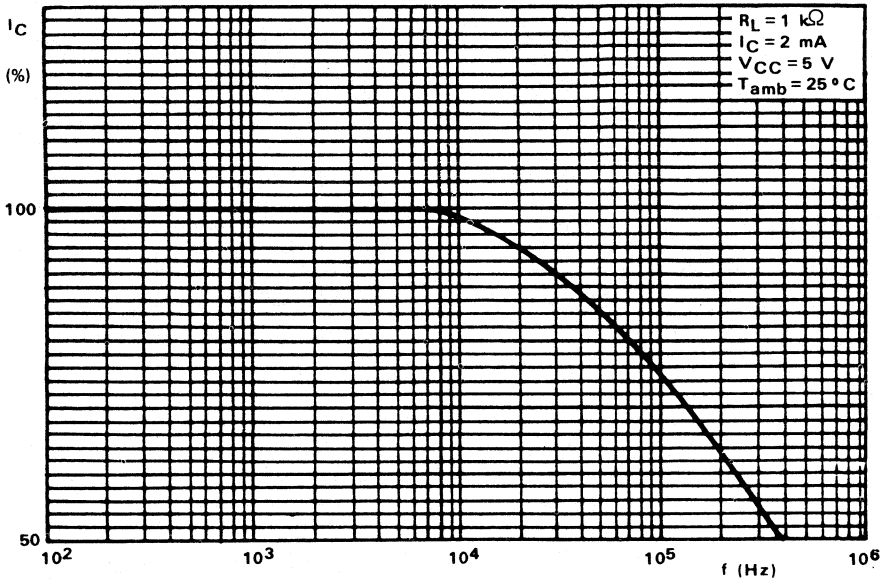

Fig. 10 Typical values.

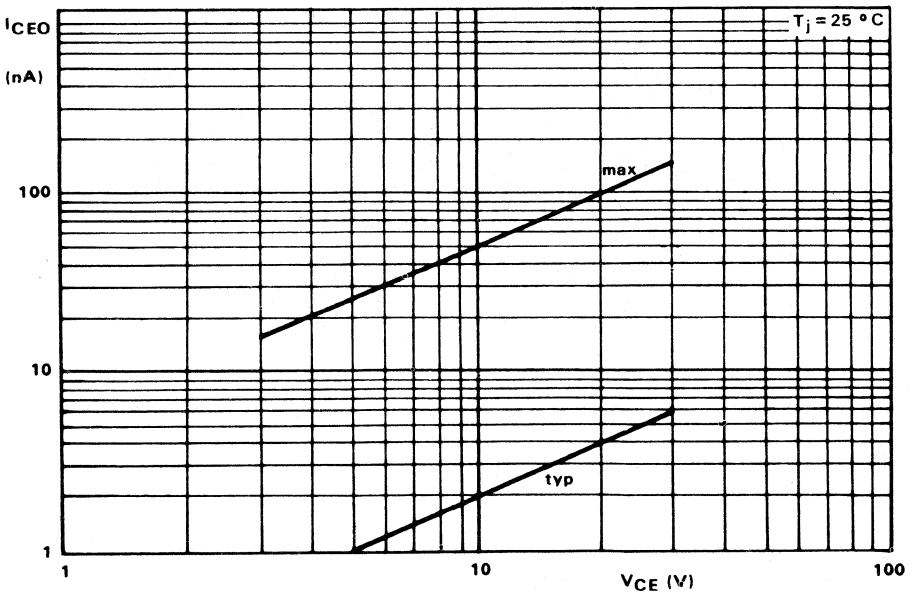

Fig. 11.

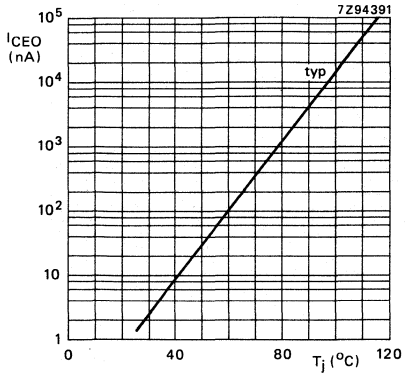

Fig. 12 $V_{CE} = 10$ V.

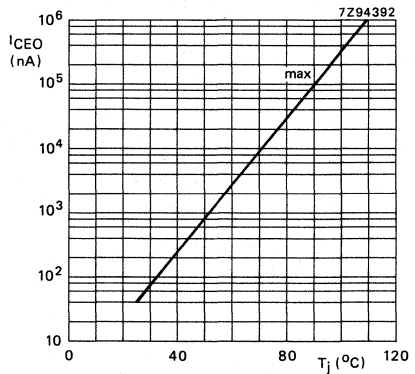

Fig. 13 $V_{CE} = 10$ V.

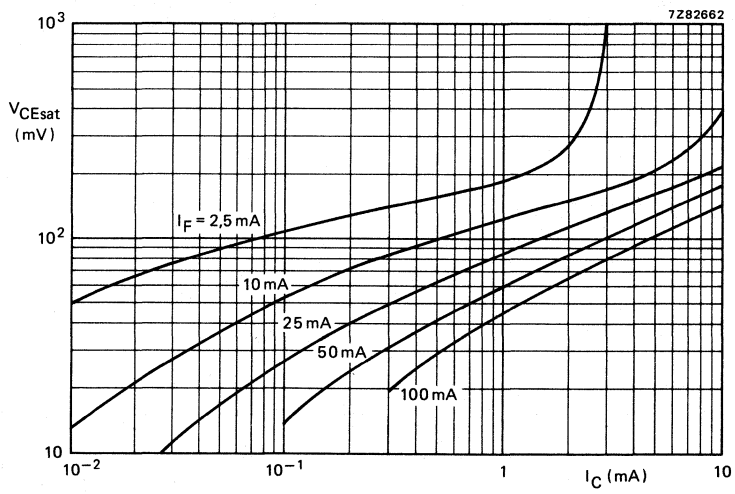

Fig. 14 $T_{amb} = 25$ °C; typical values.

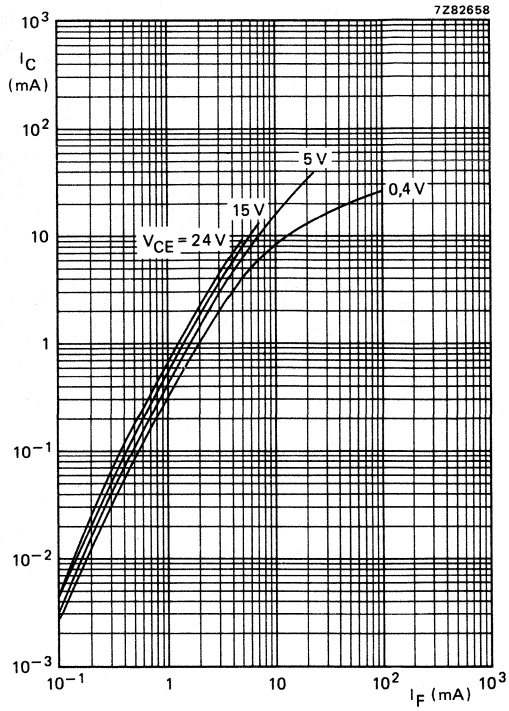

Fig. 15 $T_{amb} = 25$ °C; typical values.

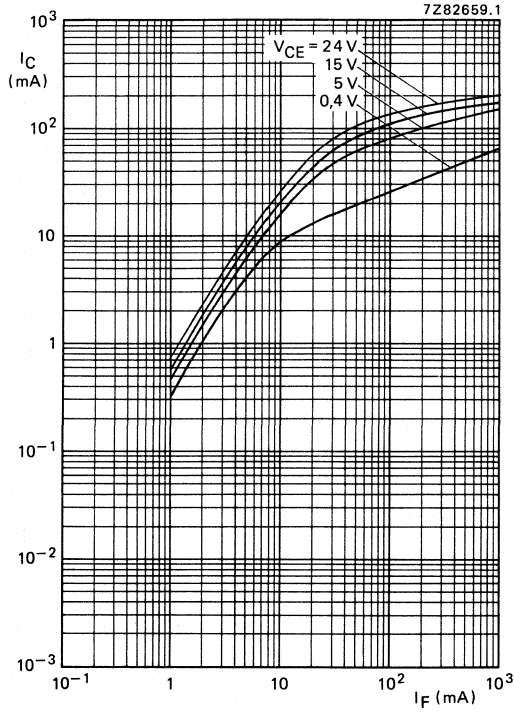

Fig. 16 $T_{amb} = 25\text{ }^\circ\text{C}$; $t_p = 10\text{ }\mu\text{s}$; $\delta = 0,01$; typical values.

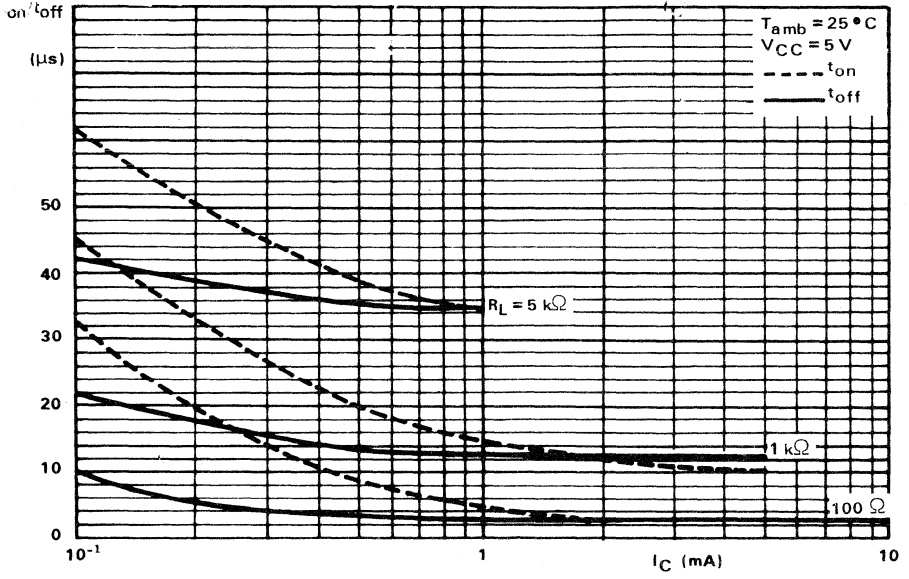

Fig. 17 Typical values.

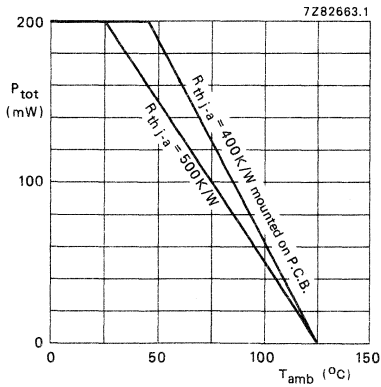

Fig. 18.

HIGH-VOLTAGE OPTOCOUPLER

The CNX72 is an optocoupler consisting of an infrared emitting GaAs diode and a silicon n-p-n photo-transistor in a dual-in-line (DIL) plastic envelope.

Features

- high current transfer ratio and a low saturation voltage suitable for use with TTL integrated circuits
- high degree of insulation (5300 V d.c.)
- working voltage of 2,5 kV (d.c.)

UL — Covered under UL component recognition FILE E90700

VDE — Approved according to VDE 0883/6.83

Complied for reinforced isolation at 250 VAC with:
DIN 57 804/VDE 0804/1.83 (isolation group C)
DIN IEC 65/VDE 0860/8.81

QUICK REFERENCE DATA

Diode

Continuous reverse voltage	V_R	max.	5 V
Forward current d.c.	I_F	max.	100 mA
peak value; $t_{ON} = 10 \mu s$; $\delta = 0,01$	I_{FRM}	max.	3 A
Total power dissipation up to $T_{amb} = 25 \text{ }^\circ\text{C}$ when mounted on a printed circuit board	P_{tot}	max.	200 mW

Transistor

Collector-emitter voltage (open base)	V_{CEO}	max.	30 V
Total power dissipation up to $T_{amb} = 25 \text{ }^\circ\text{C}$ when mounted on a printed circuit board	P_{tot}	max.	200 mW

Optocoupler

Output/input d.c. current transfer ratio (C.T.R.) $I_F = 10 \text{ mA}$; $V_{CE} = 0,4 \text{ V}$	I_C/I_F	min.	0,4
Collector cut-off current (dark) $V_{CC} = 10 \text{ V}$; working voltage (d.c.) = 2,5 kV I_F (diode) = 0 (see Fig. 4)	I_{CEW}	max.	200 nA
Collector-emitter saturation voltage $I_F = 10 \text{ mA}$; $I_C = 4 \text{ mA}$	V_{CEsat}	max.	0,4 V
Isolation voltage (d.c.)*	V_{IORM}	min.	5,3 kV

MECHANICAL DATA

SOT-90B (see Fig. 1).

* VDE recognized: $V_{IORM} 4,4 \text{ kV d.c.}$

MECHANICAL DATA

Fig. 1 SOT-90B.

Dimensions in mm

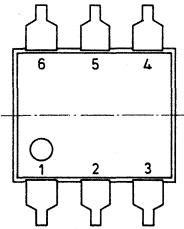
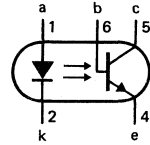
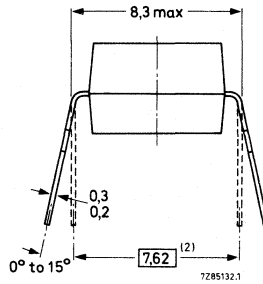
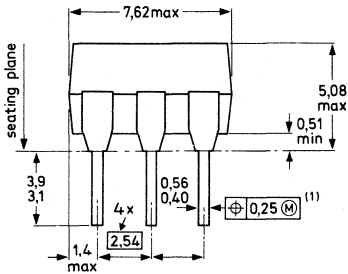

- (1) Centre-lines of all leads are within $\pm 0,125$ mm of the nominal position shown; in the worst case, the spacing between any two leads may deviate from nominal by 0,25 mm.
- (2) When the leads are parallel, the tips are in position for automatic insertion.

RATINGS

→ Limiting values in accordance with the Absolute Maximum System (IEC 134)

Diode

Continuous reverse voltage	V_R	max.	5 V
Forward current			
d.c.	I_F	max.	100 mA
peak value; $t_{ON} = 10 \mu s$; $\delta = 0,01$	I_{FRM}	max.	3 A
Total power dissipation up to $T_{amb} = 25^\circ C$ when mounted on a p.c.b.	P_{tot}	max.	200 mW

Transistor

Collector-emitter voltage (open base)	V_{CEO}	max.	30 V
Emitter-collector voltage	V_{ECO}	max.	7 V
Collector current (d.c.)	I_C	max.	100 mA
Total power dissipation up to $T_{amb} = 25^\circ C$ when mounted on a p.c.b.	P_{tot}	max.	200 mW

Optocoupler

Storage temperature	T_{stg}	-55 to +150 °C
Junction temperature	T_j	max. 125 °C
Soldering temperature up to the seating plane; $t_{sld} < 10$ s	T_{sld}	max. 260 °C

THERMAL RESISTANCE

From junction to ambient in free air diode	$R_{th j-a}$	max. 500 K/W
transistor	$R_{th j-a}$	max. 500 K/W
From junction to ambient when mounted on p.c.b. diode	$R_{th j-a}$	max. 400 K/W
transistor	$R_{th j-a}$	max. 400 K/W

ISOLATION RELATED VALUES

External air gap (clearance) input terminals to output terminals	L(IO1)	min. 7,2 mm
External tracking path (creepage dist) input terminals to output terminals	L(IO2)	min. 7,0 mm
Tracking resistance (KB-value)		KB-100/A

CHARACTERISTICS

$T_j = 25$ °C unless otherwise specified

Diode

Forward voltage $I_F = 10$ mA	V_F	typ. 1,15 V max. 1,50 V
Reverse current $V_R = 5$ V	I_R	max. 10 μ A

Transistor

Collector-emitter breakdown voltage $I_C = 1$ mA	$V_{(BR)CEO}$	min. 30 V
Collector-base breakdown voltage $I_C = 0,1$ mA	$V_{(BR)CBO}$	min. 70 V
Emitter-collector breakdown voltage $I_E = 0,1$ mA	$V_{(BR)ECO}$	min. 7 V
Collector cut-off current (dark); diode $I_F = 0$ $V_{CE} = 10$ V	I_{CEO}	typ. 2 nA max. 50 nA
$V_{CE} = 10$ V; $T_{amb} = 70$ °C	I_{CEO}	max. 10 μ A
$V_{CB} = 10$ V	I_{CBO}	max. 20 nA

Optocoupler

Output/input d.c. current transfer ratio (C.T.R.) $I_F = 10$ mA; $V_{CE} = 0,4$ V	I_C/I_F	min. 0,4 max. 1,6
Collector-emitter saturation voltage $I_F = 10$ mA; $I_C = 4$ mA	V_{CEsat}	typ. 0,19 V max. 0,40 V

DEVELOPMENT DATA

Optocoupler (continued)

Collector cut-off (light) at $T_{amb} = 0\text{ }^{\circ}\text{C}$ to $70\text{ }^{\circ}\text{C}$

$V_F = 0,8\text{ V}$; $V_{CE} = 15\text{ V}$

$I_F = 2\text{ mA}$; $V_{CE} = 0,4\text{ V}$

$I_{CE(L)}$	max.	15 μA
$I_{CE(L)}$	min.	150 μA

Collector cut-off current (dark) at working voltage $V_W = 2,5\text{ kV}$ (d.c. value);

$V_{CC} = 10\text{ V}$; $T_j = 25\text{ }^{\circ}\text{C}$ (see Fig. 4)

$V_{CC} = 10\text{ V}$; $T_j = 70\text{ }^{\circ}\text{C}$ (see Fig. 4)

I_{CEW}	max.	200 nA
	max.	100 μA

Isolation voltage* (see note 1)

V_{IORM}	min.	5,3 kV(d.c.)
		3,75 kV(r.m.s.)

Capacitance between input and output

$V = 0$; $f = 1\text{ MHz}$

C_{io}	typ.	0,6 pF
----------	------	--------

Output capacitance

$V_{CB} = 10\text{ V}$; $f = 1\text{ MHz}$

C_{bc}	max.	4,5 pF
----------	------	--------

Insulation resistance between input and output

$V_{IO} = \pm 1000\text{ V}$

R_{IO}	min.	$10^{10}\ \Omega$
	typ.	$10^{12}\ \Omega$

Switching times (see Figs 2 and 3)

Turn-on time

$I_C = 2\text{ mA}$; $V_{CC} = 5\text{ V}$; $R_L = 1\text{ k}\Omega$

$R_{BE} = 56\text{ k}\Omega$

t_{on}	max.	26 μs
----------	------	------------------

Turn-off time

$I_C = 2\text{ mA}$; $V_{CC} = 5\text{ V}$; $R_L = 1\text{ k}\Omega$

$R_{BE} = 56\text{ k}\Omega$

t_{off}	max.	2,5 μs
-----------	------	-------------------

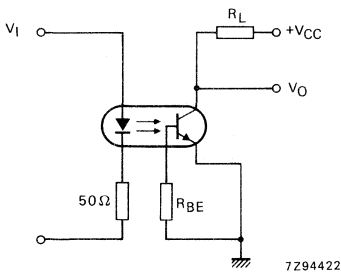

Fig. 2 Switching circuit.

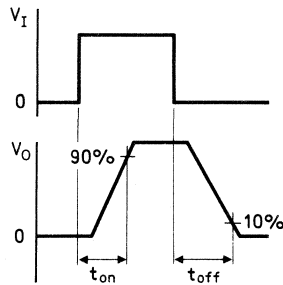

Fig. 3 Waveforms.

* VDE recognized : $V_{IORM} 4,4\text{ kV d.c.}$

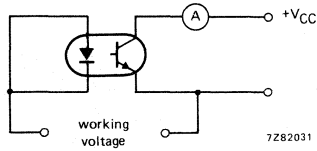

Fig. 4.

Note 1:

Every single product is tested by applying an isolation test voltage of 4500 V (r.m.s.) for 2 seconds between the shorted input (diode) leads and the shorted output (phototransistor) leads.

DEVELOPMENT DATA

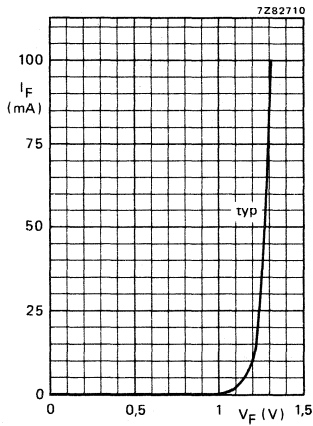

Fig. 5 $T_{amb} = 25\text{ }^\circ\text{C}$.

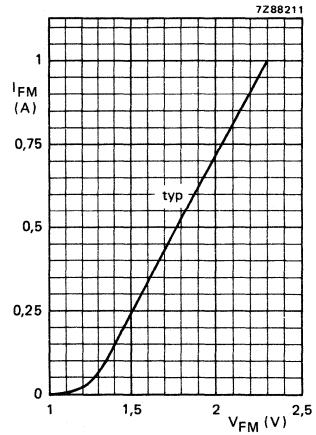

Fig. 6 $T_{amb} = 25\text{ }^\circ\text{C}$; $t_p = 10\text{ }\mu\text{s}$; $\delta = 0,01$.

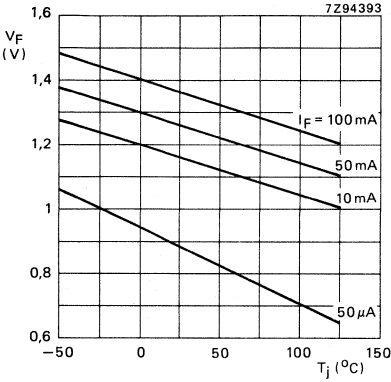

Fig. 7 Typical values.

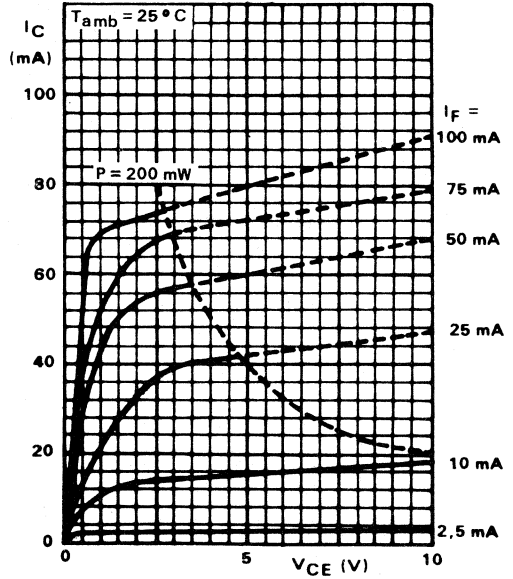

Fig. 8 Typical values.

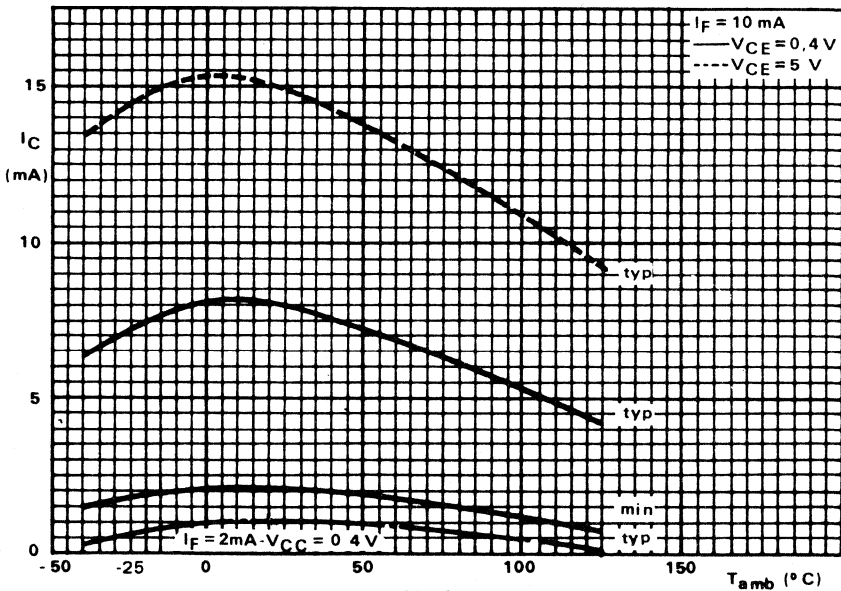

Fig. 9.

DEVELOPMENT DATA

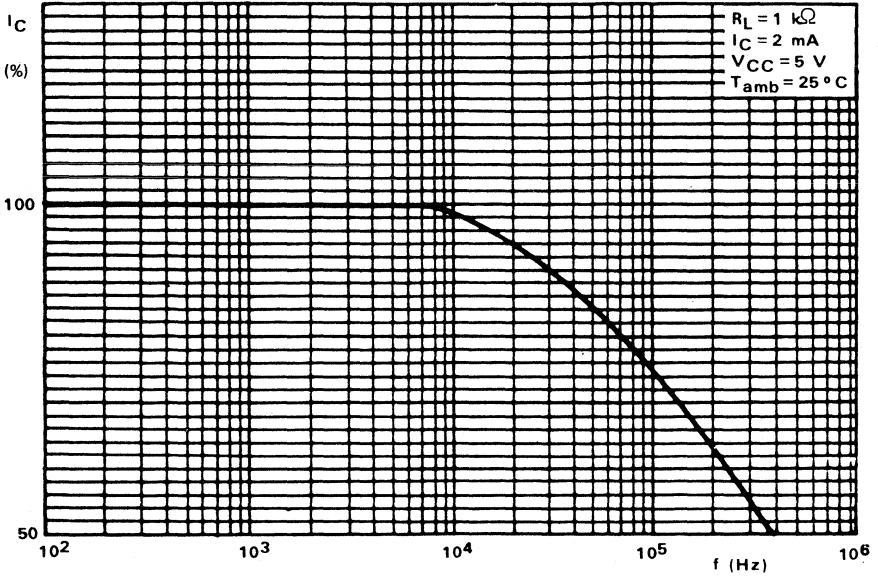

Fig. 10 Typical values.

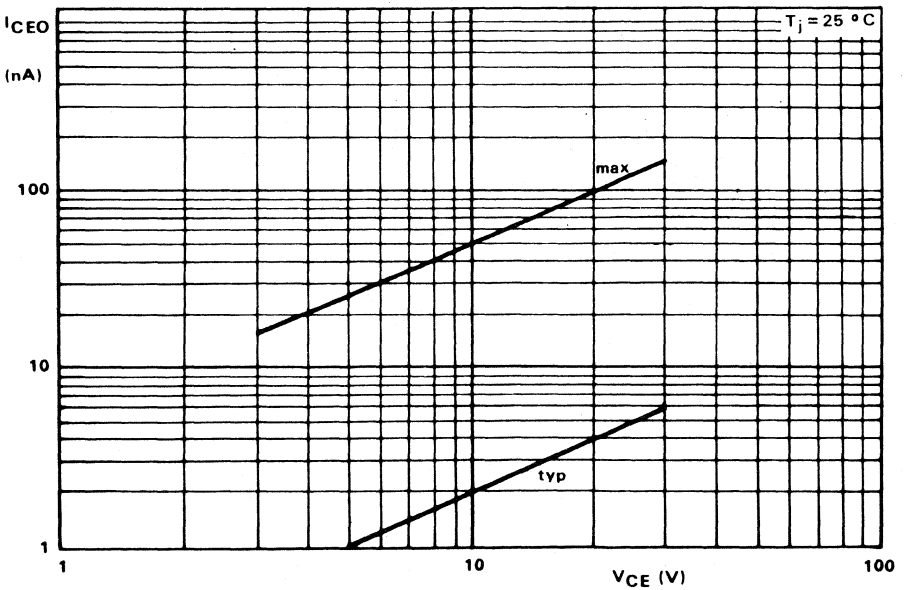

Fig. 11.

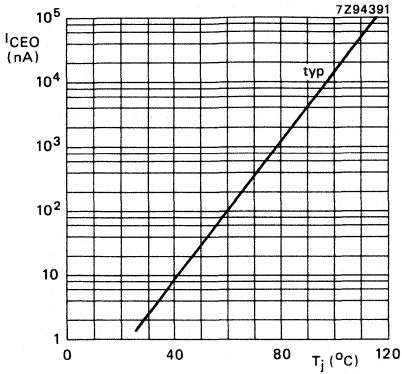

Fig. 12 $V_{CE} = 10 \text{ V}$.

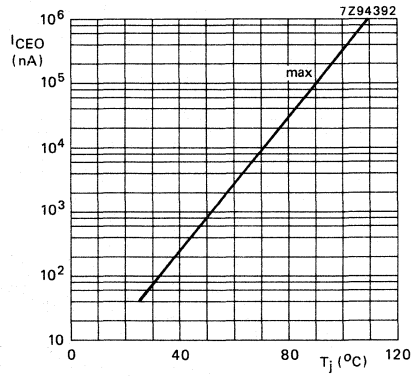

Fig. 13 $V_{CE} = 10 \text{ V}$.

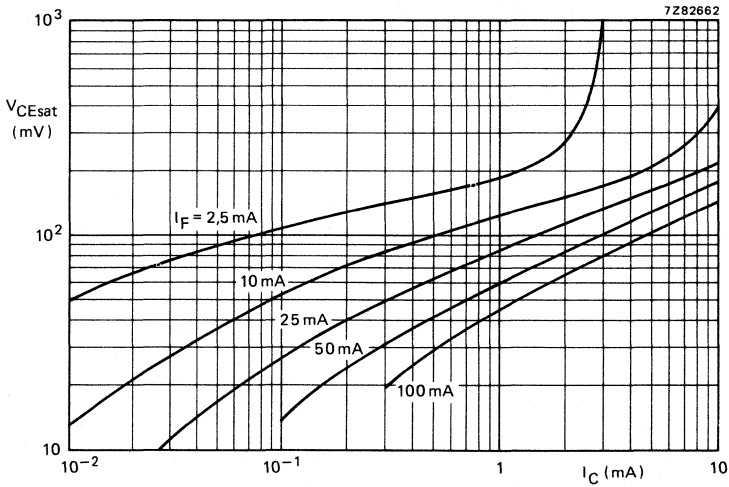

Fig. 14 $T_{amb} = 25 \text{ }^\circ\text{C}$; typical values.

DEVELOPMENT DATA

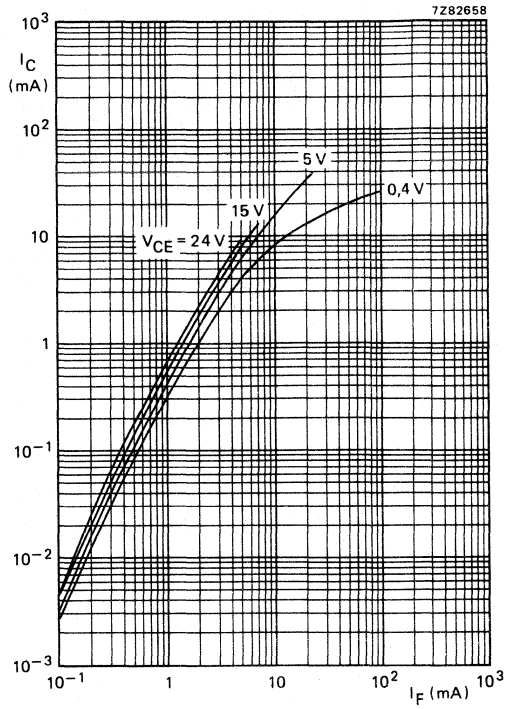

Fig. 15 $T_{amb} = 25^{\circ}C$; typical values.

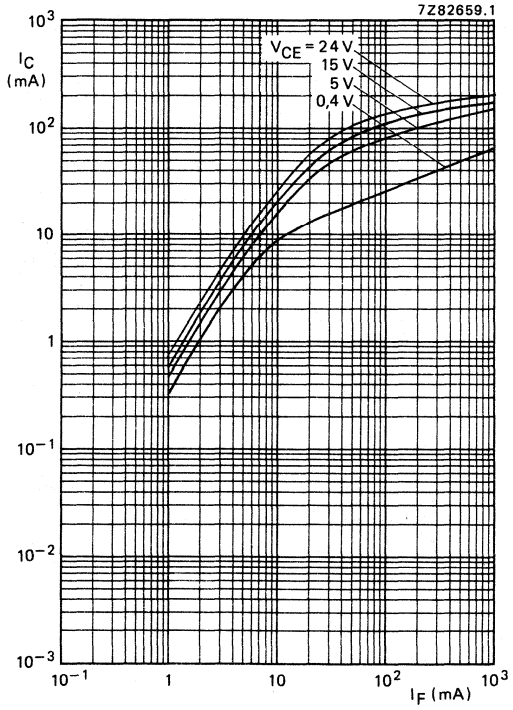

Fig. 16 $T_{amb} = 25\text{ }^{\circ}\text{C}$; $t_p = 10\text{ }\mu\text{s}$; $\delta = 0,01$; typical values.

DEVELOPMENT DATA

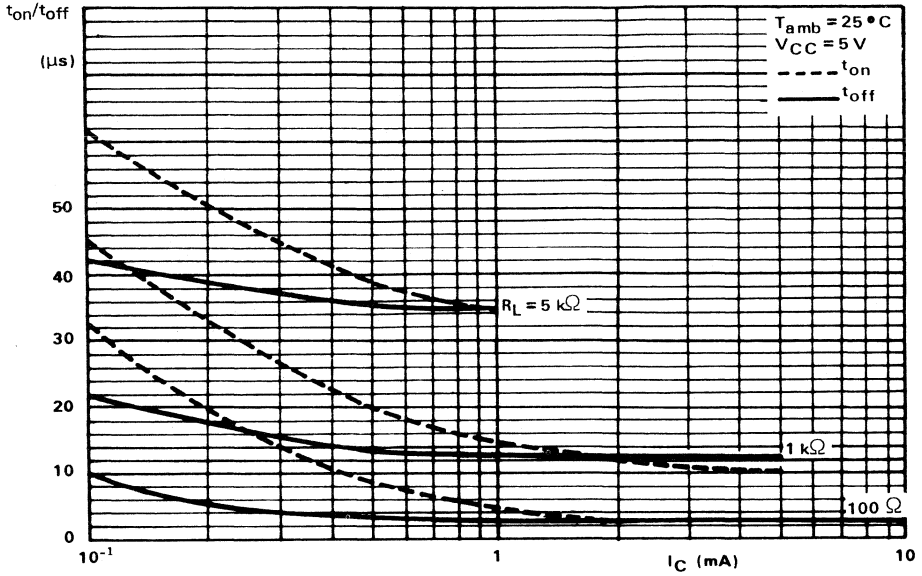

Fig. 17 Typical values.

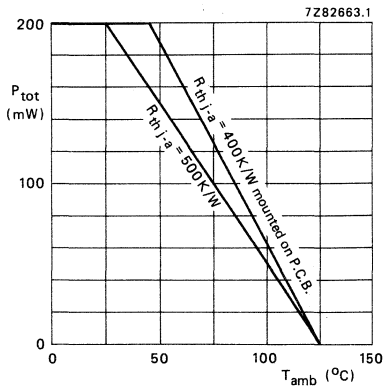

Fig. 18.

HIGH-VOLTAGE OPTOCOUPLER

The CNX82 is an optocoupler consisting of an infrared emitting GaAs diode and a silicon n-p-n photo-transistor in a dual-in-line (DIL) plastic envelope. The base is not connected.

Features

- high current transfer ratio and a low saturation voltage suitable for use with TTL integrated circuits
- high degree of a.c. and d.c. insulation (3750 V r.m.s. and 5300 V d.c.)
- working voltage of 2,5 kV (d.c.)

UL — Covered under UL component recognition FILE E90700

VDE — Approved according to VDE 0883/6.83

Complied for reinforced isolation at 250 VAC with:
DIN 57 804/VDE 0804/1.83 (isolation group C)
DIN IEC 65/VDE 0860/8.81

QUICK REFERENCE DATA

Diode

Continuous reverse voltage	V_R	max.	5 V
Forward current			
d.c.	I_F	max.	100 mA
peak value; $t_{ON} = 10 \mu s$; $\delta = 0,01$	I_{FRM}	max.	3 A
Total power dissipation up to $T_{amb} = 25 \text{ }^\circ\text{C}$ when mounted on a p.c.b.	P_{tot}	max.	200 mW

Transistor

Collector-emitter voltage (open base)	V_{CEO}	max.	50 V
Total power dissipation up to $T_{amb} = 25 \text{ }^\circ\text{C}$ when mounted on a p.c.b.	P_{tot}	max.	200 mW

Optocoupler

Output/input d.c. current transfer ratio (C.T.R.) $I_F = 10 \text{ mA}$; $V_{CE} = 0,4 \text{ V}$	I_C/I_F	min.	0,4
Collector cut-off current (dark) $V_{CC} = 10 \text{ V}$; working voltage (d.c.) = 2,5 kV I_F (diode) = 0 (see Fig. 4)	I_{CEW}	max.	200 nA
Collector-emitter saturation voltage $I_F = 10 \text{ mA}$; $I_C = 4 \text{ mA}$	V_{CEsat}	max.	0,4 V
Isolation voltage (d.c.)	V_{IORM}	min.	5,3 kV

MECHANICAL DATA

SOT-212 (see Fig. 1).

MECHANICAL DATA

Fig. 1 SOT-212.

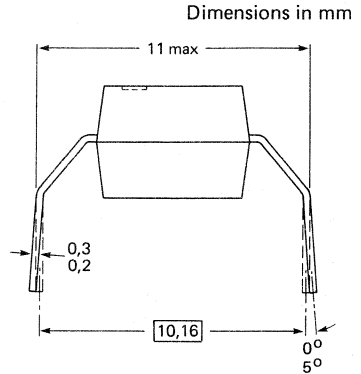
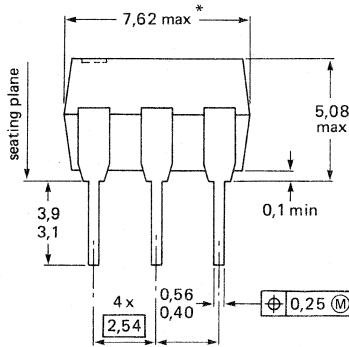

7295606

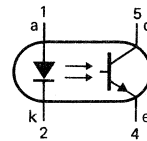
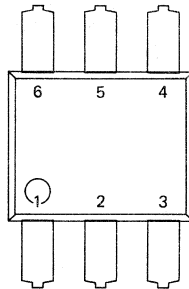

The base is not connected.

* During 1986, the body length will be increased to max. 8,75 mm.

RATINGS

Limiting values in accordance with the Absolute Maximum System (IEC 134)

Diode

Continuous reverse voltage	V_R	max.	5 V
Forward current	I_F	max.	100 mA
d.c.	I_{FRM}	max.	3 A
peak value; $t_{on} = 10 \mu s$; $\delta = 0,01$			
Total power dissipation up to $T_{amb} = 25 \text{ }^\circ\text{C}$ when mounted on a p.c.b.	P_{tot}	max.	200 mW

Transistor

Collector-emitter voltage (open base)	V_{CEO}	max.	50 V
Emitter-collector voltage	V_{ECO}	max.	7 V
Collector current (d.c.)	I_C	max.	100 mA
Total power dissipation up to $T_{amb} = 25 \text{ }^\circ\text{C}$ when mounted on a p.c.b.	P_{tot}	max.	200 mW

Optocoupler

Storage temperature	T_{stg}		-55 to +150 °C
Junction temperature	T_j	max.	125 °C
Soldering temperature up to the seating plane; $t_{sld} < 10$ s	T_{sld}	max.	260 °C

THERMAL RESISTANCE

From junction to ambient in free air			
diode	$R_{th\ j-a}$	max.	500 K/W
transistor	$R_{th\ j-a}$	max.	500 K/W
From junction to ambient when mounted on p.c.b.			
diode	$R_{th\ j-a}$	max.	400 K/W
transistor	$R_{th\ j-a}$	max.	400 K/W

ISOLATION RELATED VALUES

External air gap (clearance) input terminals to output terminals	$L(I/O1)$	min.	9,6 mm
External tracking path (creepage dist) input terminals to output terminals	$L(I/O2)$	min.	7,0 mm
Tracking resistance (KB-value)	V_{TR}		KB-100/A

CHARACTERISTICS

$T_j = 25$ °C unless otherwise specified

Diode

Forward voltage $I_F = 10$ mA	V_F	typ.	1,15 V
		max.	1,50 V
Reverse current $V_R = 5$ V	I_R	max.	10 μ A

Transistor

Collector-emitter breakdown voltage $I_C = 1$ mA	$V_{(BR)CEO}$	min.	50 V
Emitter-collector breakdown voltage $I_E = 0,1$ mA	$V_{(BR)ECO}$	min.	7 V
Collector cut-off current (dark); diode $I_F = 0$ $V_{CE} = 10$ V	I_{CEO}	typ.	2 nA
		max.	50 nA
$V_{CE} = 10$ V; $T_{amb} = 70$ °C	I_{CEO}	max.	10 μ A

Optocoupler

Output/input d.c. current transfer ratio (C.T.R.) $I_F = 10$ mA; $V_{CE} = 0,4$ V	I_C/I_F	min.	0,4
		typ.	0,8
$I_F = 10$ mA; $V_{CE} = 5$ V	I_C/I_F	typ.	1,5
Collector cut-off current (light) $T_{amb} \leq 70$ °C; $V_F = 0,8$ V; $V_{CE} = 15$ V	$I_{CE(L)}$	max.	15 μ A
$T_{amb} \leq 70$ °C; $I_F = 2$ mA; $V_{CE} = 0,4$ V	$I_{CE(L)}$	min.	150 μ A

Optocoupler (continued)

Collector - emitter saturation voltage

$I_F = 10 \text{ mA}; I_C = 4 \text{ mA}$

V_{CEsat}	typ.	0,19 V
	max.	0,40 V

Collector cut-off current (dark) at working voltage $V_W = 2,5 \text{ kV}$ (d.c. value);
 $V_{CC} = 10 \text{ V}; T_j = 25 \text{ }^\circ\text{C}$ (see Fig. 4) *
 $V_{CC} = 10 \text{ V}; T_j = 70 \text{ }^\circ\text{C}$ (see Fig. 4) *

I_{CEW}	max.	200 nA
	max.	100 μA

Isolation voltage
 (see note 1)

V_{IORM}	min.	5,3 kV(d.c.) 3,75 kV(r.m.s.)
------------	------	---------------------------------

Capacitance between input and output
 $V = 0; f = 1 \text{ MHz}$

C_{io}	typ.	0,6 pF
----------	------	--------

Insulation resistance between input and output
 $V_{IO} = \pm 1000 \text{ V}$

R_{IO}	min.	$10^{10} \Omega$
	typ.	$10^{12} \Omega$

Switching times (see Figs 2 and 3)

Turn-on time

$I_C = 2 \text{ mA}; V_{CC} = 5 \text{ V}; R_L = 100 \Omega$
 $I_C = 2 \text{ mA}; V_{CC} = 5 \text{ V}; R_L = 1 \text{ k}\Omega$

t_{on}	typ.	3 μs
	typ.	12 μs

Turn-off time

$I_C = 2 \text{ mA}; V_{CC} = 5 \text{ V}; R_L = 100 \Omega$
 $I_C = 2 \text{ mA}; V_{CC} = 5 \text{ V}; R_L = 1 \text{ k}\Omega$

t_{off}	typ.	3 μs
	typ.	12 μs

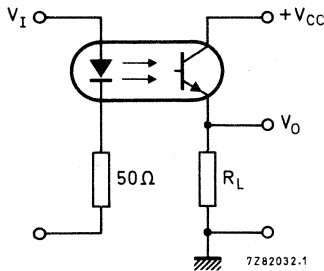

Fig. 2 Switching circuit.

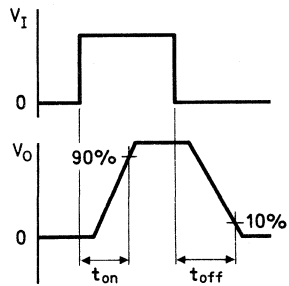

Fig. 3 Waveforms.

* The two parameters are tested on a sample basis for 1000 h.

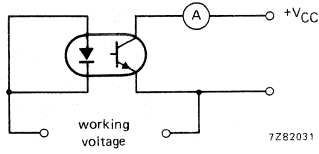

Fig. 4.

Note 1:

Every single product is tested by applying an isolation test voltage of 4500 V (r.m.s.) for 2 seconds between the shorted input (diode) leads and the shorted output (phototransistor) leads.

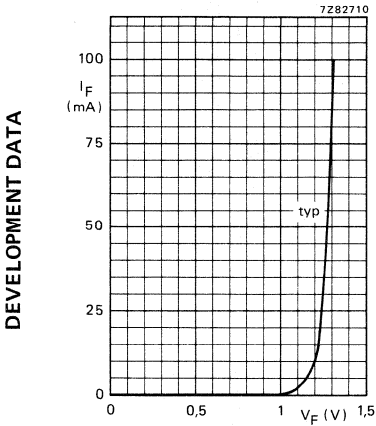

Fig. 5 T_{amb} = 25 °C.

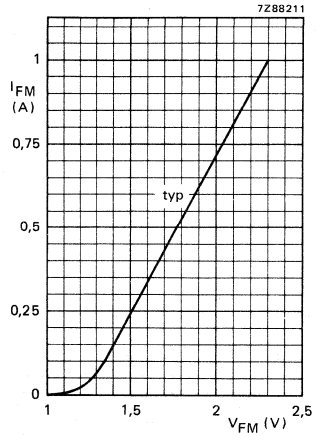

Fig. 6 T_{amb} = 25 °C; t_p = 10 μs; δ = 0,01.

DEVELOPMENT DATA

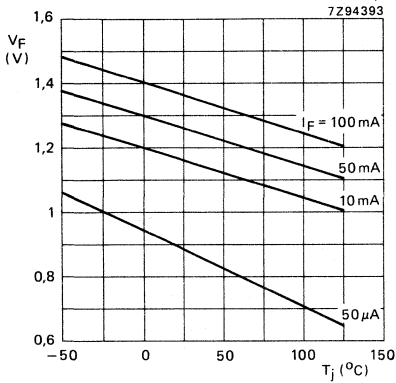

Fig. 7 Typical values.

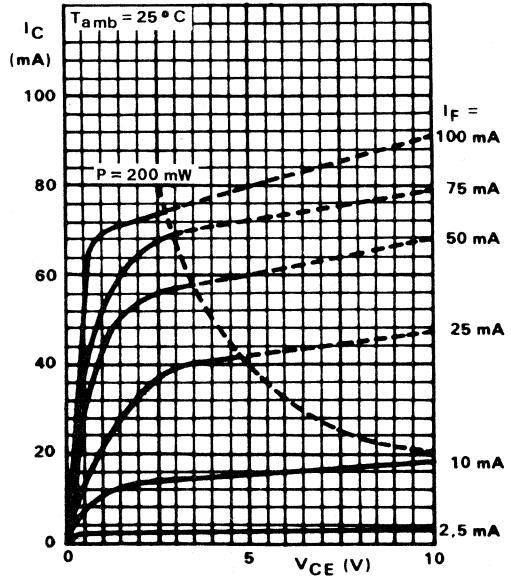

Fig. 8 Typical values.

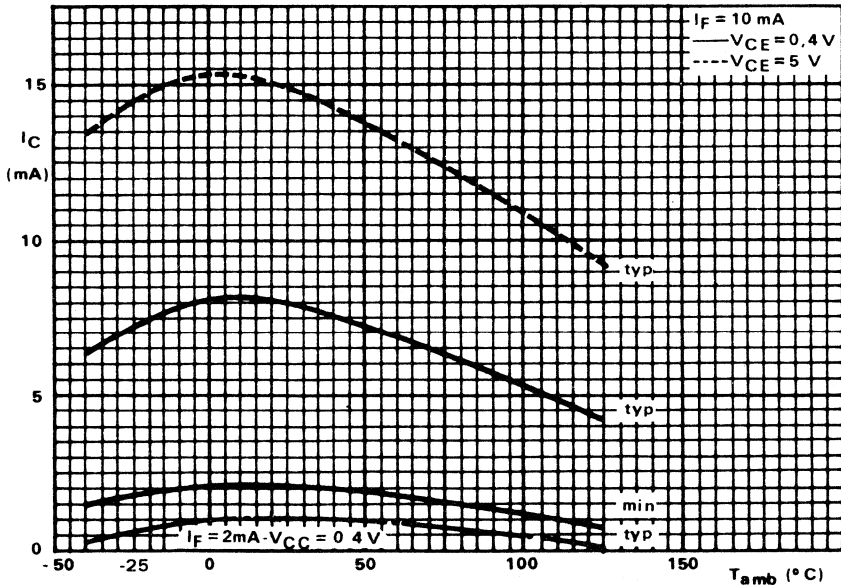

Fig. 9.

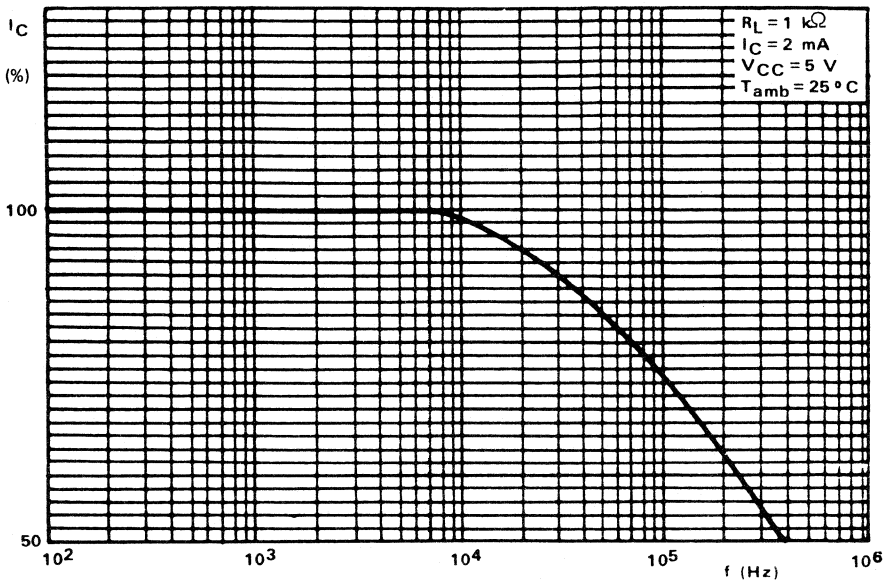

Fig. 10 Typical values.

DEVELOPMENT DATA

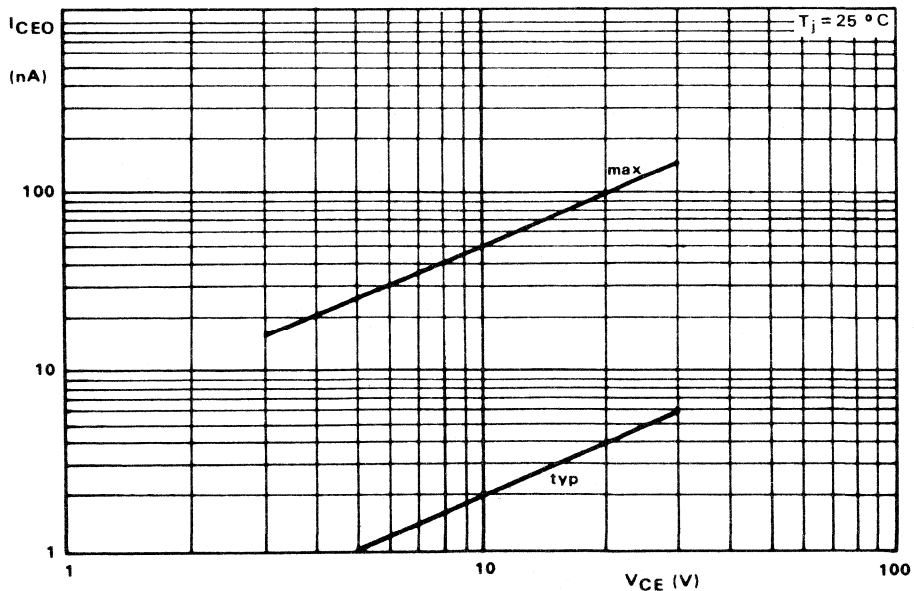

Fig. 11.

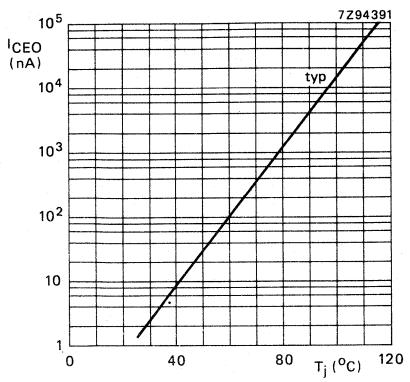

Fig. 12 $V_{CE} = 10$ V.

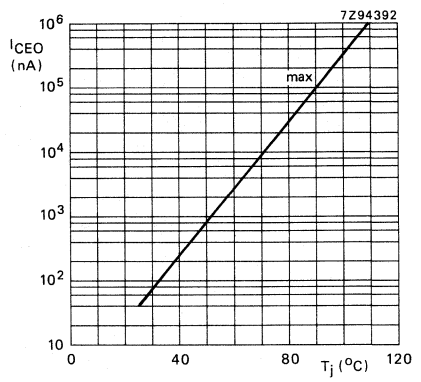

Fig. 13 $V_{CE} = 10$ V.

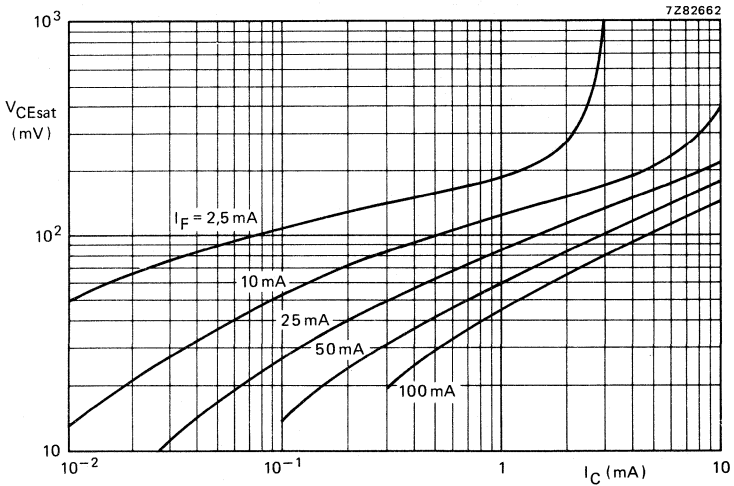

Fig. 14 $T_{amb} = 25$ $^{\circ}C$; typical values.

DEVELOPMENT DATA

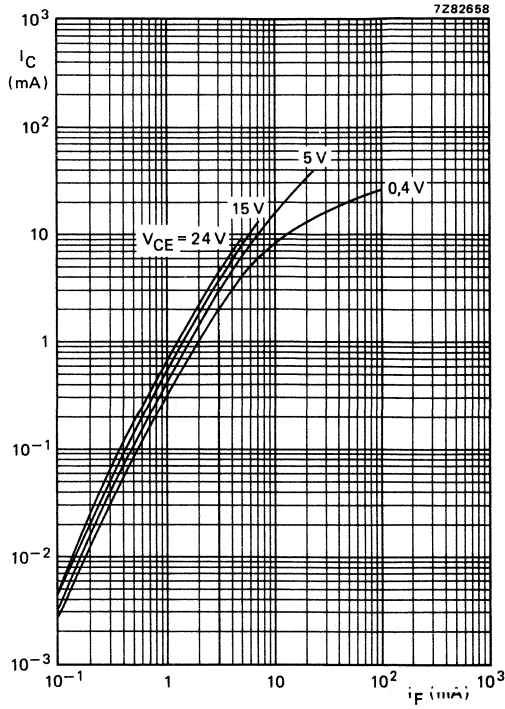

Fig. 15 $T_{amb} = 25\text{ }^\circ\text{C}$; typical values.

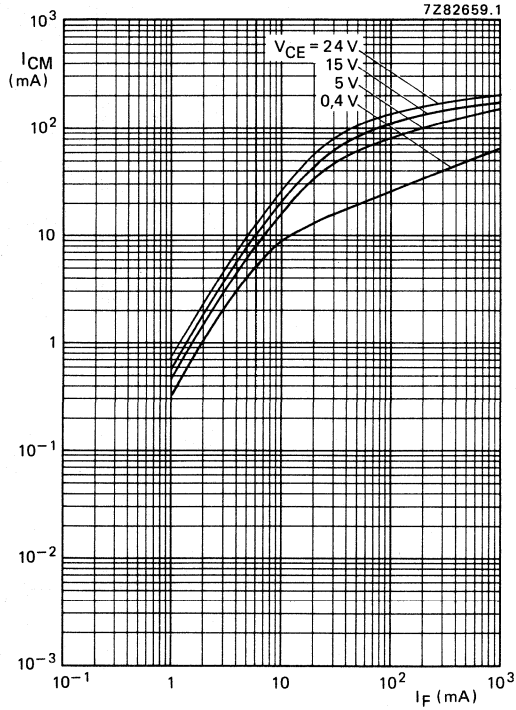

Fig. 16 $T_{amb} = 25\text{ }^\circ\text{C}$; $t_p = 10\text{ }\mu\text{s}$; $\delta = 0,01$; typical values.

DEVELOPMENT DATA

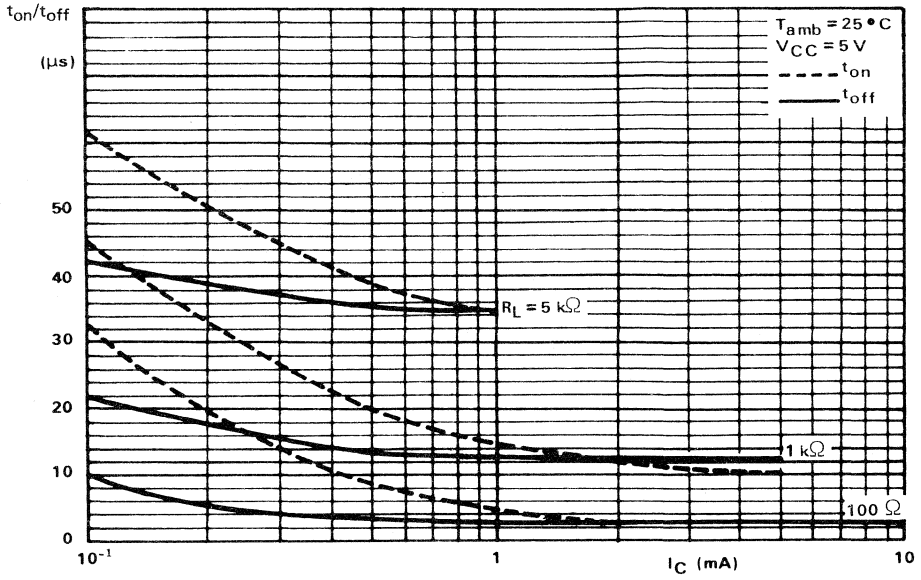

Fig. 17 Typical values.

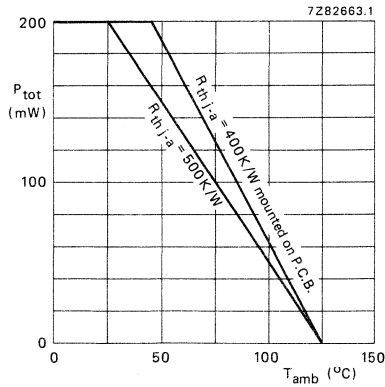

Fig. 18.

HIGH-VOLTAGE OPTOCOUPLER

The CNX83 is an optocoupler consisting of an infrared emitting GaAs diode and a silicon n-p-n phototransistor in a dual-in-line (DIL) plastic envelope. The device is derived from the CNX82 but has the base connected.

Features

- high current transfer ratio and a low saturation voltage suitable for use with TTL integrated circuits
- high degree of a.c. and d.c. insulation (3750 V r.m.s. and 5300 V d.c.)
- working voltage of 2,5 kV (d.c.)

Requests for UL recognition and VDE approval are pending.

QUICK REFERENCE DATA

Diode

Continuous reverse voltage	V_R	max.	5 V
Forward current	I_F	max.	100 mA
d.c.	I_{FRM}	max.	3 A
peak value; $t_{on} = 10 \mu s$; $\delta = 0,01$			
Total power dissipation up to $T_{amb} = 25 \text{ }^\circ\text{C}$ when mounted on a p.c.b.	P_{tot}	max.	200 mW

Transistor

Collector-emitter voltage (open base)	V_{CEO}	max.	50 V
Total power dissipation up to $T_{amb} = 25 \text{ }^\circ\text{C}$ when mounted on a p.c.b.	P_{tot}	max.	200 mW

Optocoupler

Output/input d.c. current transfer ratio (C.T.R.) $I_F = 10 \text{ mA}$; $V_{CE} = 4 \text{ V}$	I_C/I_F	min.	0,4
Collector cut-off current (dark) $V_{CC} = 10 \text{ V}$; working voltage (d.c.) = 2,5 kV I_F (diode) = 0 (see Fig. 4)	I_{CEW}	max.	200 nA
Collector-emitter saturation voltage $I_F = 10 \text{ mA}$; $I_C = 4 \text{ mA}$	V_{CEsat}	max.	0,4 V
Isolation voltage (d.c.)	V_{IORM}	min.	5,3 kV

MECHANICAL DATA

SOT-212 (see Fig. 1).

MECHANICAL DATA

Fig. 1 SOT-212.

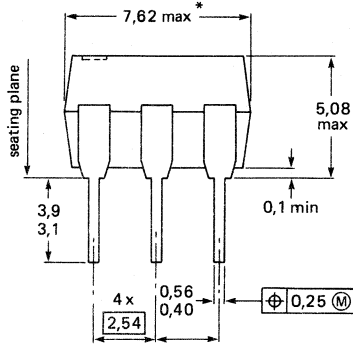

Dimensions in mm

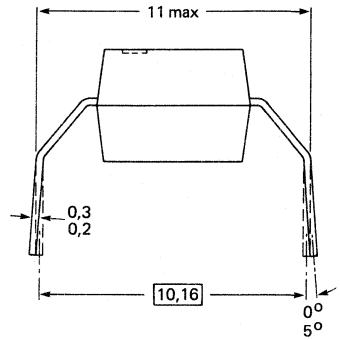

7295606

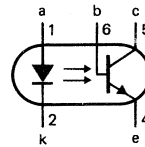
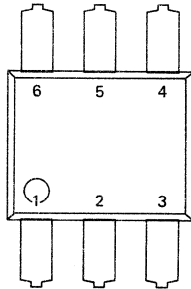

* During 1986, the body length will be increased to max. 8,75 mm.

RATINGS

Limiting values in accordance with the Absolute Maximum System (IEC 134)

Diode

Continuous reverse voltage	V_R	max.	5 V
Forward current	I_F	max.	100 mA
d.c.	I_{FRM}	max.	3 A
peak value; $t_{ON} = 10 \mu s$; $\delta = 0,01$			
Total power dissipation up to $T_{amb} = 25 \text{ }^\circ\text{C}$ when mounted on a p.c.b.	P_{tot}	max.	200 mW

Transistor

Collector-base voltage (open emitter)	V_{CBO}	max.	70 V
Collector-emitter voltage (open base)	V_{CEO}	max.	50 V
Emitter-collector voltage	V_{ECO}	max.	7 V
Collector current (d.c.)	I_C	max.	100 mA
Total power dissipation up to $T_{amb} = 25 \text{ }^\circ\text{C}$ when mounted on a p.c.b.	P_{tot}	max.	200 mW

Optocoupler

Storage temperature	T_{stg}	-55 to +150 °C
Junction temperature	T_j	max. 125 °C
Soldering temperature up to the seating plane; $t_{sld} < 10$ s	T_{sld}	max. 260 °C

THERMAL RESISTANCE

From junction to ambient in free air			
diode	$R_{th\ j-a}$	max.	500 K/W
transistor	$R_{th\ j-a}$	max.	500 K/W
From junction to ambient when mounted on p.c.b.			
diode	$R_{th\ j-a}$	max.	400 K/W
transistor	$R_{th\ j-a}$	max.	400 K/W

ISOLATION RELATED VALUES

External air gap (clearance) input terminals to output terminals	L(I01)	min.	9,6 mm
External tracking path (creepage dist) input terminals to output terminals	L(I02)	min.	7,0 mm
Tracking resistance (KB-value)			KB-100/A

CHARACTERISTICS

$T_j = 25$ °C unless otherwise specified

Diode

Forward voltage $I_F = 10$ mA	V_F	typ. max.	1,15 V 1,50 V
Reverse current $V_R = 5$ V	I_R	max.	10 μ A

Transistor

Collector-emitter breakdown voltage $I_C = 1$ mA	$V_{(BR)CEO}$	min.	50 V
Emitter-collector breakdown voltage $I_E = 0,1$ mA	$V_{(BR)ECO}$	min.	7 V
Collector-base breakdown voltage at $I_C = 0,1$ mA	$V_{(BR)CBO}$	min.	70 V
Collector cut-off current (dark); diode $I_F = 0$ $V_{CE} = 10$ V	I_{CEO}	typ. max.	2 nA 50 nA
$V_{CE} = 10$ V; $T_{amb} = 70$ °C	I_{CEO}	max.	10 μ A
$V_{CB} = 10$ V; $T_{amb} = 25$ °C	I_{CBO}	max.	20 nA

Optocoupler

Output/input d.c. current transfer ratio (C.T.R.)

$I_F = 10$ mA; $V_{CE} = 0,4$ V	I_C/I_F	min. typ.	0,4 0,8
$I_F = 10$ mA; $V_{CE} = 5$ V	I_C/I_F	typ.	1,5

Optocoupler (continued)

Collector cut-off current (light)

$T_{amb} \leq 70\text{ }^{\circ}\text{C}; V_F = 0,8\text{ V}; V_{CE} = 15\text{ V}$
 $T_{amb} \leq 70\text{ }^{\circ}\text{C}; I_F = 2\text{ mA}; V_{CE} = 0,4\text{ V}$

$I_{CE(L)}$	max.	15 μA
$I_{CE(L)}$	min.	150 μA

Collector-emitter saturation voltage

$I_F = 10\text{ mA}; I_C = 4\text{ mA}$

V_{CEsat}	typ.	0,19 V
	max.	0,40 V

Collector cut-off current (dark) at working voltage $V_W = 2,5\text{ kV}$ (d.c. value);

$V_{CC} = 10\text{ V}; T_J = 25\text{ }^{\circ}\text{C}$ (see Fig. 4)
 $V_{CC} = 10\text{ V}; T_J = 70\text{ }^{\circ}\text{C}$ (see Fig. 4)

I_{CEW}	max.	200 nA *
	max.	100 μA *

Isolation voltage (see note 1)

V_{IORM}	max.	5,3 kV(d.c.) 3,75 kV(r.m.s.)
------------	------	---------------------------------

Collector capacitance at $f = 1\text{ MHz}$

$I_E = I_e = 0; V_{CB} = 10\text{ V}$

C_{bc}	typ.	4,5 pF
----------	------	--------

Capacitance between input and output

$V = 0; f = 1\text{ MHz}$

C_{io}	typ.	0,6 pF
----------	------	--------

Insulation resistance between input and output

$V_{IO} = \pm 1000\text{ V}$

R_{IO}	min.	$10^{10}\ \Omega$
	typ.	$10^{12}\ \Omega$

Switching times (see Figs 2 and 3)

Turn-on time

$I_C = 2\text{ mA}; V_{CC} = 5\text{ V}; R_L = 100\ \Omega$
 $I_C = 2\text{ mA}; V_{CC} = 5\text{ V}; R_L = 1\text{ k}\Omega$

t_{on}	typ.	3 μs
	typ.	12 μs

Turn-off time

$I_C = 2\text{ mA}; V_{CC} = 5\text{ V}; R_L = 100\ \Omega$
 $I_C = 2\text{ mA}; V_{CC} = 5\text{ V}; R_L = 1\text{ k}\Omega$

t_{off}	typ.	3 μs
	typ.	12 μs

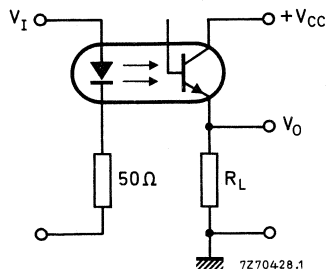

Fig. 2. Switching circuit.

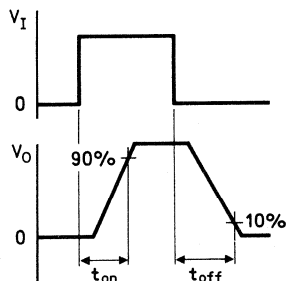

Fig. 3. Waveforms.

* The two parameters are tested on a sample basis for 1000 h.

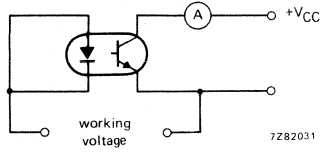

Fig. 4.

Note 1:

Every single product is tested by applying an isolation test voltage of 4500 V (r.m.s.) for 2 seconds between the shorted input (diode) leads and the shorted output (phototransistor) leads.

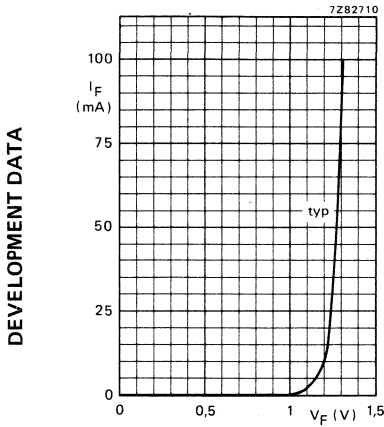

Fig. 5 $T_{amb} = 25\text{ }^\circ\text{C}$.

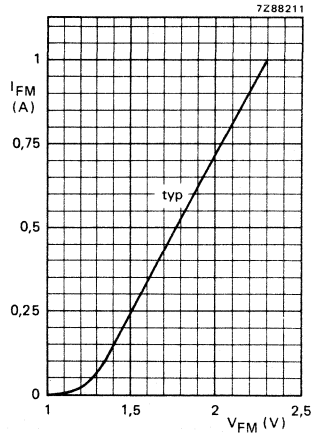

Fig. 6 $T_{amb} = 25\text{ }^\circ\text{C}$; $t_p = 10\text{ }\mu\text{s}$; $\delta = 0,01$.

DEVELOPMENT DATA

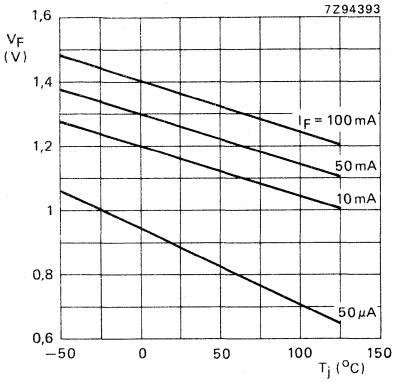

Fig. 7 Typical values.

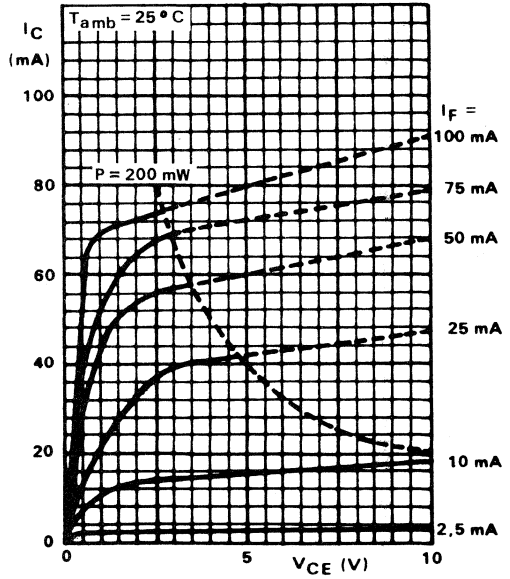

Fig. 8 Typical values.

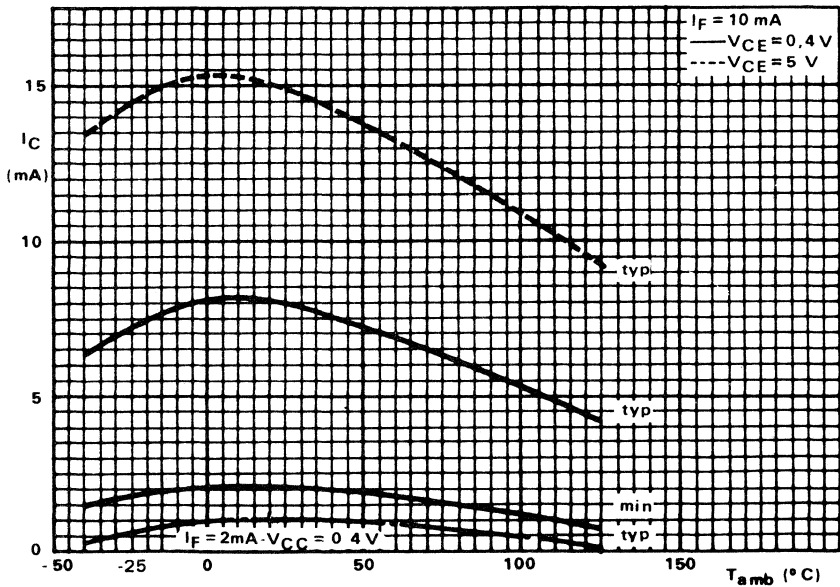

Fig. 9.

DEVELOPMENT DATA

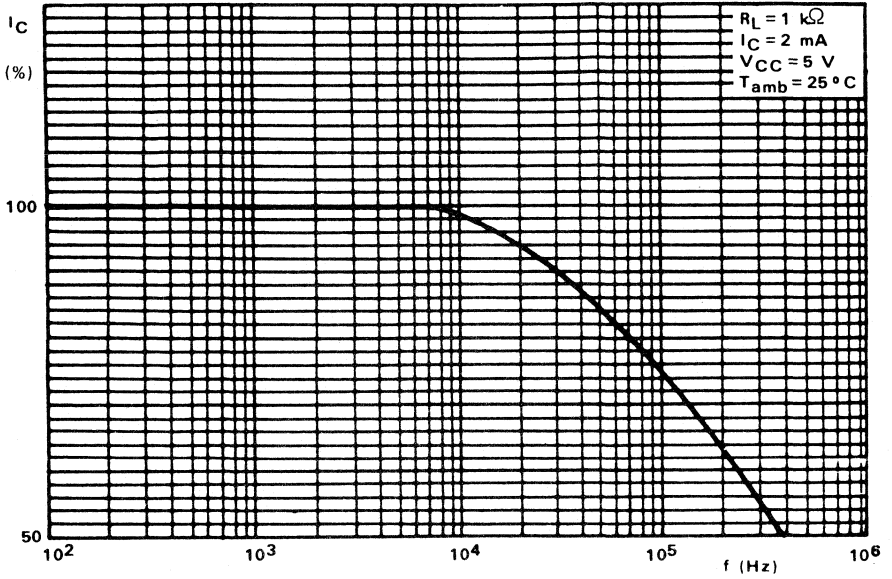

Fig. 10 Typical values.

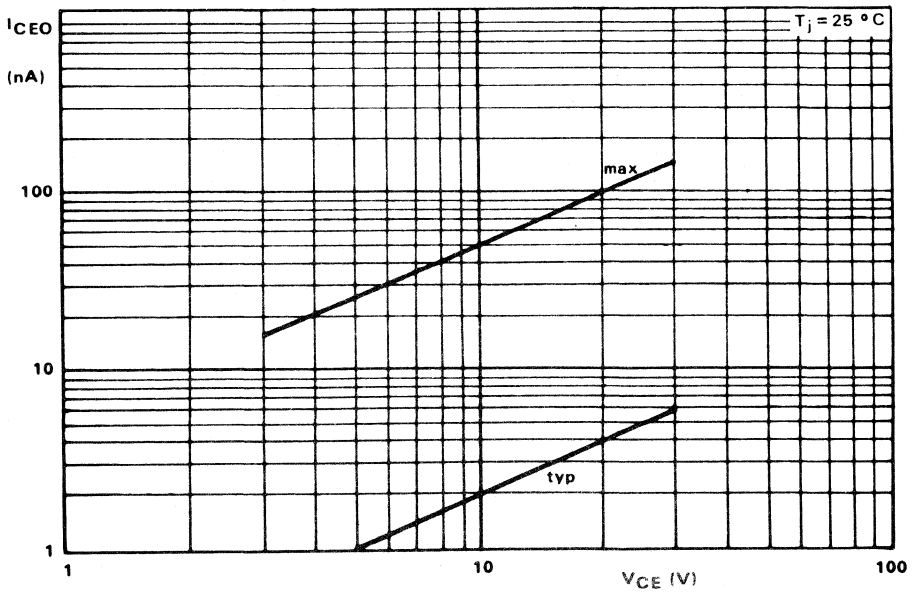

Fig. 11.

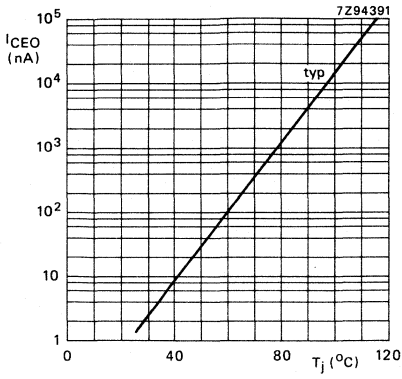

Fig. 12 $V_{CE} = 10$ V.

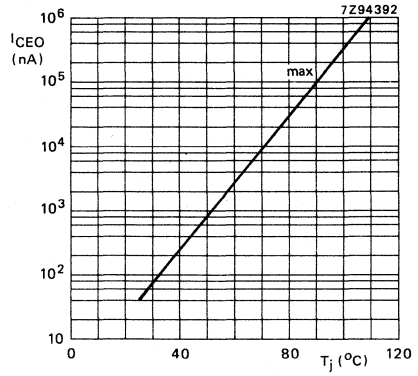

Fig. 13 $V_{CE} = 10$ V.

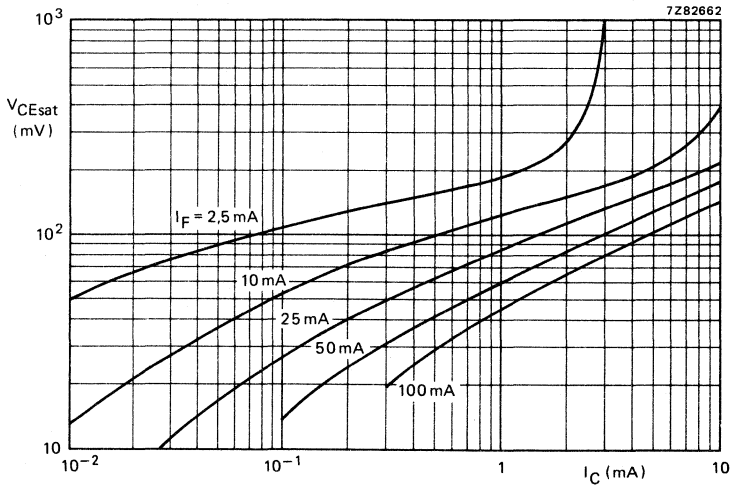

Fig. 14 $T_{amb} = 25$ °C; typical values.

DEVELOPMENT DATA

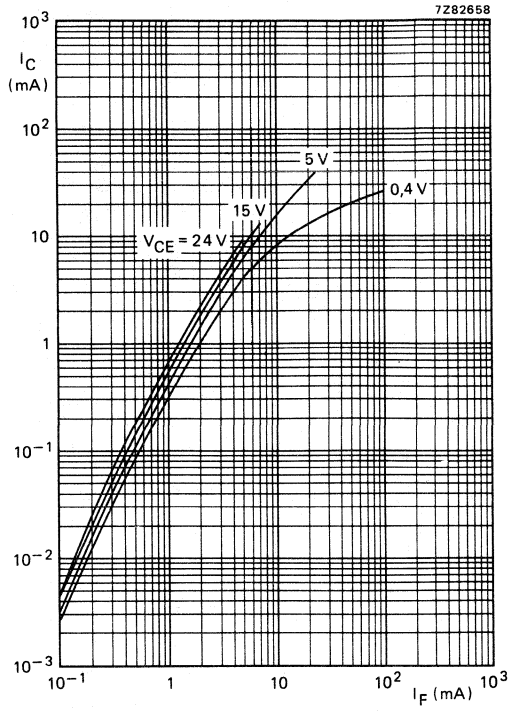

Fig. 15 $T_{amb} = 25\text{ }^\circ\text{C}$; typical values.

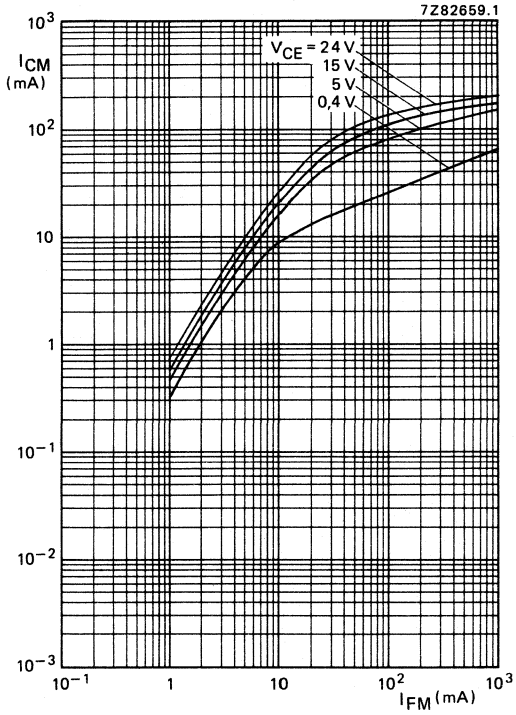

Fig. 16 $T_{amb} = 25\text{ }^{\circ}\text{C}$; $t_p = 10\text{ }\mu\text{s}$; $\delta = 0,01$; typical values.

DEVELOPMENT DATA

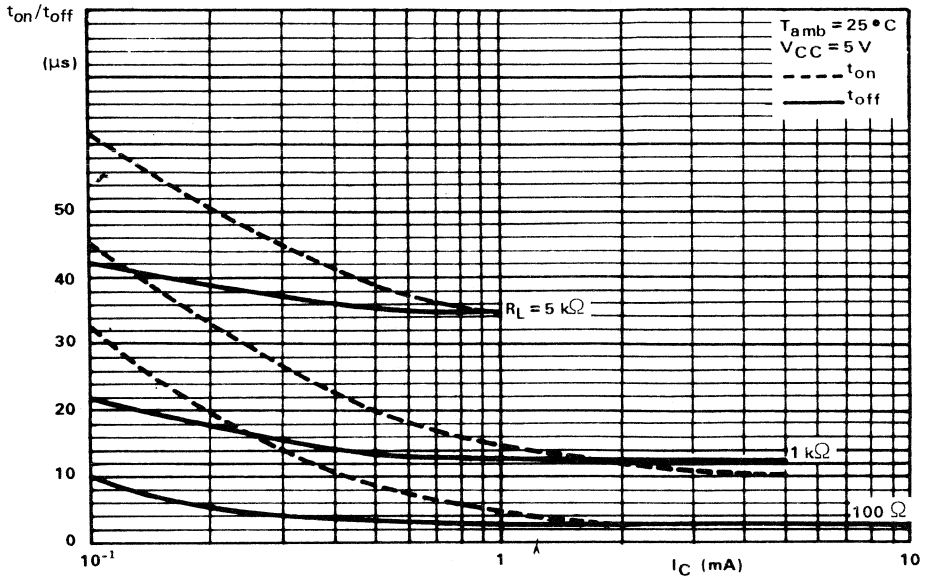

Fig. 17 Typical values.

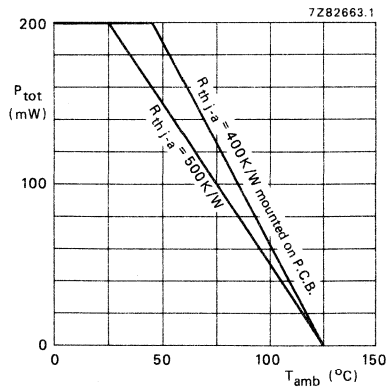

Fig. 18.

OPTOCOUPERS

Optically coupled isolators consisting of an infrared emitting GaAs diode and a silicon n-p-n photo-transistor with accessible base. Plastic envelopes. Suitable for TTL integrated circuits.

Features of these products:

- high output/input d.c. current transfer ratio;
- low saturation voltage;
- high isolation voltage of 3,12 kV (r.m.s.) and 4,4 kV (d.c.);
- working voltage 2,5 kV (d.c.)

QUICK REFERENCE DATA

Diode

Continuous reverse voltage	V_R	max.	5 V
Forward current d.c. (peak value); $t_p = 10 \mu s$; $\delta = 0,01$	I_F I_{FRM}	max. max.	100 mA 3 A
Total power dissipation up to $T_{amb} = 25 \text{ }^\circ\text{C}$	P_{tot}	max.	200 mW

Transistor

Collector-emitter voltage (open base)	V_{CEO}	max.	30 V
Total power dissipation up to $T_{amb} = 25 \text{ }^\circ\text{C}$	P_{tot}	max.	200 mW

Photocoupler

Output/input d.c. current transfer ratio (C.T.R.) $I_F = 10 \text{ mA}$; $V_{CE} = 0,4 \text{ V}$; ($I_B = 0$)	CNY57 CNY57A	I_C/I_F	min.	0,2
		I_C/I_F	min.	0,4
Collector cut-off current (dark) $V_{CC} = 10 \text{ V}$; working voltage (d.c.) = 2,5 kV diode: $I_F = 0$ (see also Fig. 2)		I_{CEW}	max.	200 nA
Isolation voltage (d.c.)		V_{IORM}	min.	4,4 kV

MECHANICAL DATA

SOT-90B (see Fig. 1).

MECHANICAL DATA

Fig. 1 SOT-90B.

Dimensions in mm

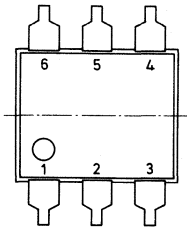
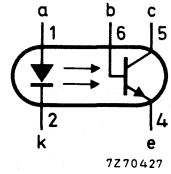
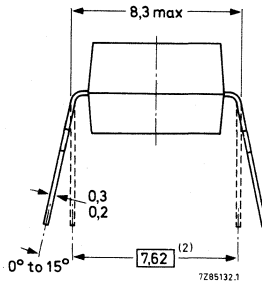
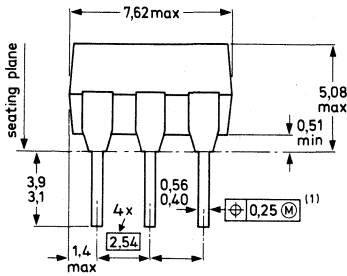

⊕ Positional accuracy.

Ⓜ Maximum material condition.

- (1) Centre-lines of all leads are within $\pm 0,125$ mm of the nominal position shown; in the worst case, the spacing between any two leads may deviate from nominal by 0,25 mm.
- (2) When the leads are parallel, the tips are in position for automatic insertion.

RATINGS

Limiting values in accordance with the Absolute Maximum System (IEC 134)

Diode

Continuous reverse voltage	V_R	max.	5 V
Forward current			
d.c.	I_F	max.	100 mA
(peak value); $t_p = 10 \mu s$; $\delta = 0,01$	I_{FRM}	max.	3 A
Total power dissipation up to $T_{amb} = 25 \text{ }^\circ\text{C}$	P_{tot}	max.	200 mW
Operating junction temperature	T_j	max.	125 $^\circ\text{C}$

Transistor

Collector-emitter voltage (open base)	V_{CEO}	max.	30 V
Collector-base voltage (open emitter)	V_{CBO}	max.	70 V
Emitter-collector voltage (open base)	V_{ECO}	max.	7 V
Collector current (d.c.)	I_C	max.	100 mA
Total power dissipation up to $T_{amb} = 25 \text{ }^\circ\text{C}$	P_{tot}	max.	200 mW
Operating junction temperature	T_j	max.	125 $^\circ\text{C}$

Optocoupler

Storage temperature	T_{stg}	-55 to +150 °C
Lead soldering temperature up to the seating plane; $t_{sld} < 10$ s	T_{sld}	max. 260 °C

THERMAL RESISTANCE

From junction to ambient in free air diode	$R_{th\ j-a}$	=	500 K/W
transistor	$R_{th\ j-a}$	=	500 K/W
From junction to ambient, device mounted on a printed-circuit board diode	$R_{th\ j-a}$	=	400 K/W
transistor	$R_{th\ j-a}$	=	400 K/W

ISOLATION RELATED VALUES

External air gap (clearance) input terminals to output terminals	$L(I01)$	min.	7,2 mm
External tracking path (creepage dist) input terminals to output terminals	$L(I02)$	min.	7,0 mm
Tracking resistance (KB-value)			KB-100/A

CHARACTERISTICS

$T_j = 25$ °C unless otherwise specified

Diode

Forward voltage $I_F = 10$ mA	V_F	typ. <	1,15 V 1,5 V
Reverse current $V_R = 5$ V	I_R	<	10 μ A

Transistor (diode: $I_F = 0$)

Collector cut-off current (dark) $V_{CE} = 10$ V	I_{CEO}	typ. <	2 nA 50 nA
$V_{CE} = 10$ V; $T_{amb} = 70$ °C	I_{CEO}	<	10 μ A
$V_{CB} = 10$ V	I_{CBO}	<	20 nA

Optocoupler ($I_B = 0$)*

Output/input d.c. current transfer ratio (C.T.R.) $I_F = 10$ mA; $V_{CE} = 0,4$ V	CNY57	I_C/I_F	0,2 to 0,8 typ. 0,5
	CNY57A	I_C/I_F	> typ. 0,4 1

* Where the phototransistor receives light from the diode the O (for open base) has been omitted from the symbols.

CNY57 CNY57A

Collector cut-off current (dark) see Fig. 2

$V_{CC} = 10\text{ V}$; working voltage (d.c.) = 2,5 kV

$V_{CC} = 10\text{ V}$; working voltage (d.c.) = 2,5 kV; $T_j = 70\text{ }^\circ\text{C}$

I_{CEW}	<	200	nA
I_{CEW}	<	100	μA

			CNY57	CNY57A
Collector-emitter breakdown voltage $I_C = 1\text{ mA}$	$V_{(BR)CEO}$	min.	30	30 V
Collector-base breakdown voltage $I_C = 0,1\text{ mA}$	$V_{(BR)CBO}$	min.	70	70 V
Emitter-collector breakdown voltage $I_E = 0,1\text{ mA}$	$V_{(BR)ECO}$	min.	7	7 V
Collector-emitter saturation voltage $I_F = 10\text{ mA}$; $I_C = 2\text{ mA}$	V_{CEsat}	typ.	0,15	—
		<	0,4	— V
$I_F = 10\text{ mA}$; $I_C = 4\text{ mA}$	V_{CEsat}	typ.	—	0,19 V
		<	—	0,4 V
Isolation voltage*	V_{IORM}	min.	4,4	4,4 kV (d.c.)
Capacitance between input and output $I_F = 0$; $V = 0$; $f = 1\text{ MHz}$	C_{io}	typ.	3,12	3,12 kV (r.m.s.)
			0,6	0,6 pF
Output capacitance at $F = 1\text{ MHz}$ $V_{CB} = 10\text{ V}$	C_{bc}	typ.	4,5	4,5 pF
Insulation resistance between input and output $\pm V_{IO} = 1\text{ kV}$	r_{IO}	>	10^{10}	$10^{10}\ \Omega$
		typ.	10^{12}	$10^{12}\ \Omega$
Switching times (see Figs 3 and 4) $I_{Con} = 2\text{ mA}$; $V_{CC} = 5\text{ V}$; $R_L = 100\ \Omega$				
Turn-on time	t_{on}	typ.	3	— μs
Turn-off time	t_{off}	typ.	3	— μs
$I_{Con} = 4\text{ mA}$; $V_{CC} = 5\text{ V}$; $R_L = 100\ \Omega$				
Turn-on time	t_{on}	typ.	—	5 μs
Turn-off time	t_{off}	typ.	—	5 μs

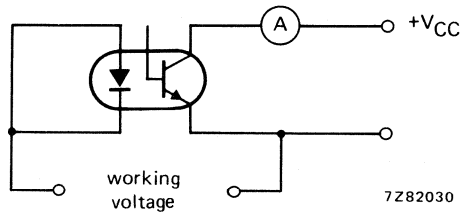

Fig. 2.

* Tested on a sample basis with a voltage of 4400 V (d.c.) for 1 minute between the shorted input (diode) leads and the shorted output (phototransistor) leads.

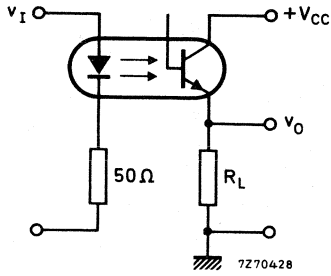

Fig. 3 Switching circuit.

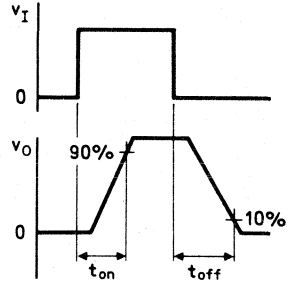

Fig. 4 Waveforms.

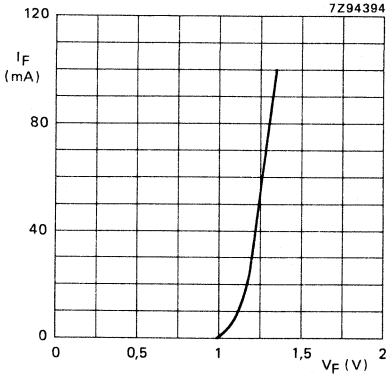

Fig. 5 $T_{amb} = 25\text{ }^{\circ}\text{C}$; typical values.

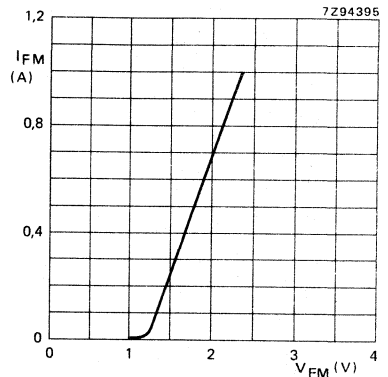

Fig. 6 $T_{amb} = 25\text{ }^{\circ}\text{C}$; $t_p = 10\text{ }\mu\text{s}$; $\delta = 0,01$; typical values.

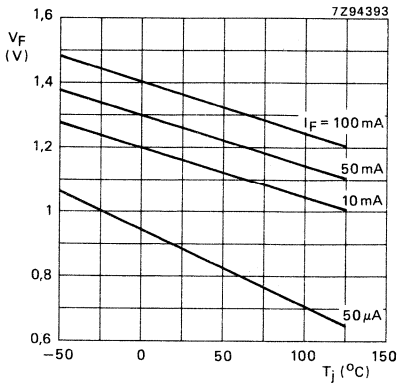

Fig. 7 Typical values.

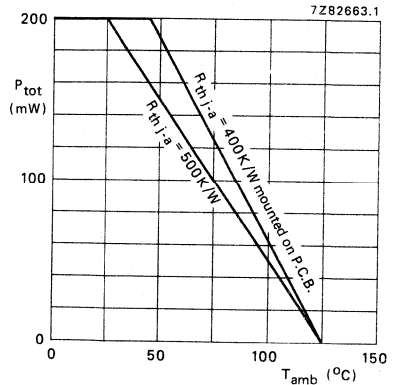

Fig. 8

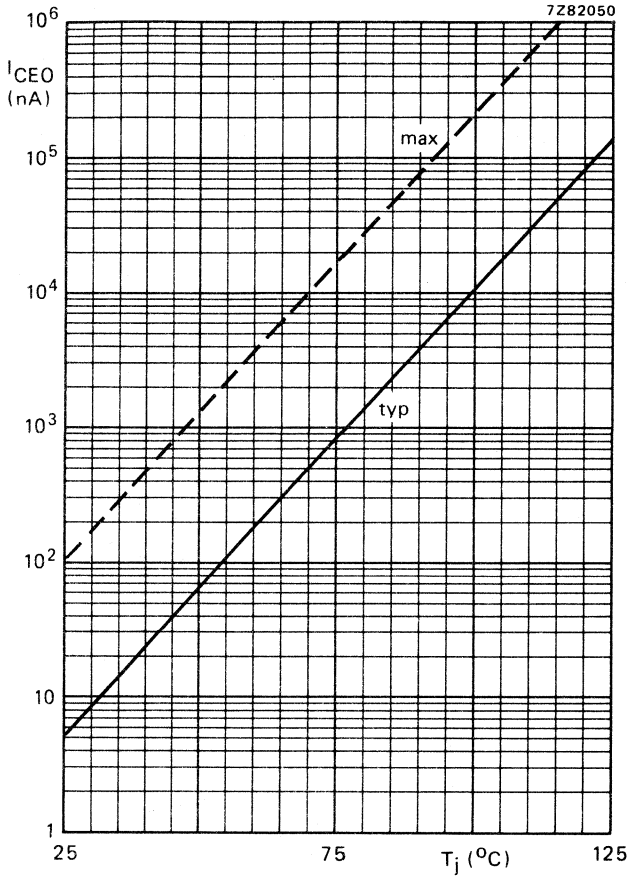

Fig. 9 $I_F = 0$; $V_{CE} = 10$ V.

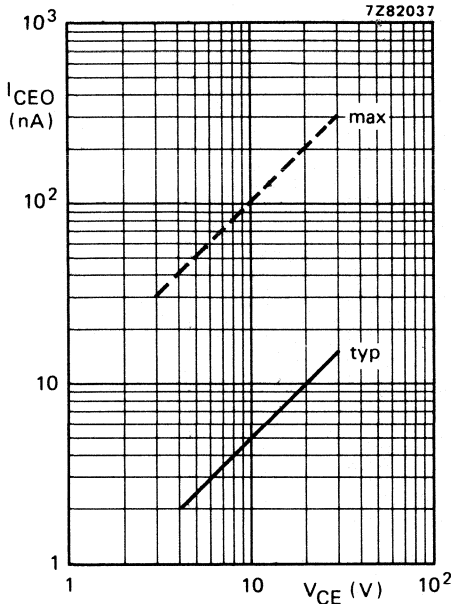

Fig. 10 $I_F = 0$; $T_j = 25^\circ\text{C}$.

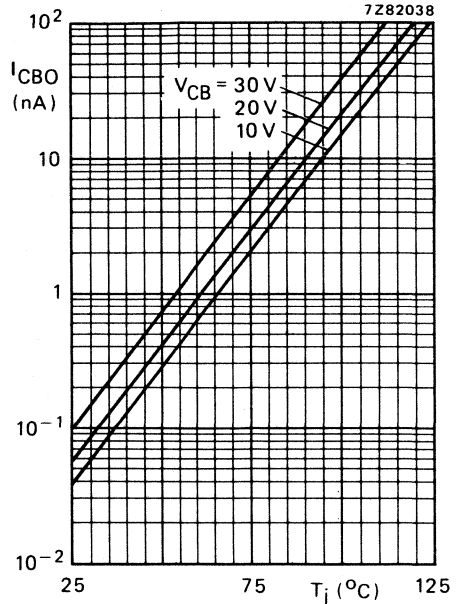

Fig. 11 $I_F = 0$; typical values.

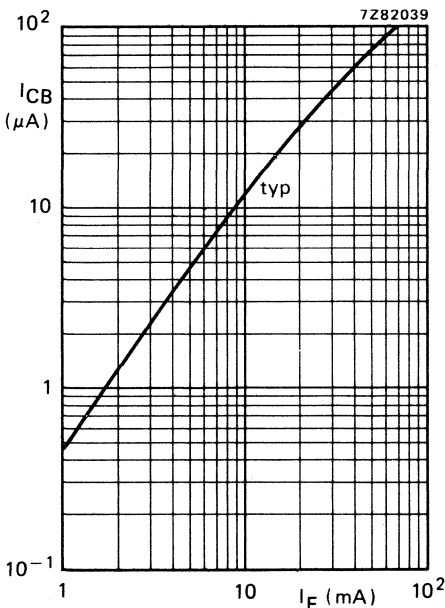

Fig. 12 $I_E = 0$; $V_{CB} = 5\text{ V}$; $T_{amb} = 25^\circ\text{C}$.

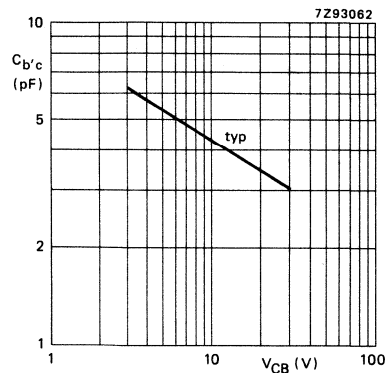

Fig. 13 $f = 1\text{ MHz}$.

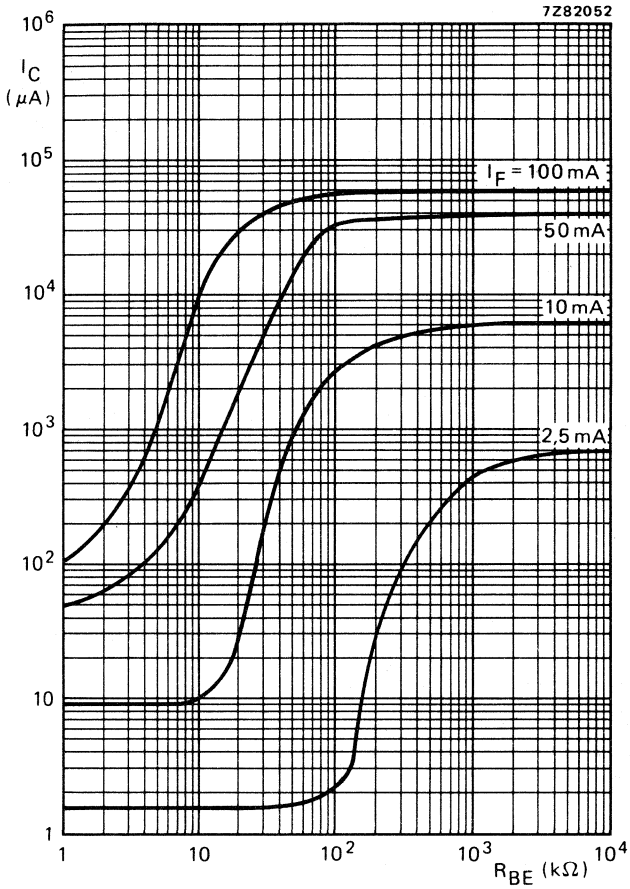

Fig. 14 CNY57; $I_B = 0$; $V_{CE} = 5 \text{ V}$; $T_{\text{amb}} = 25 \text{ }^\circ\text{C}$; typical values.

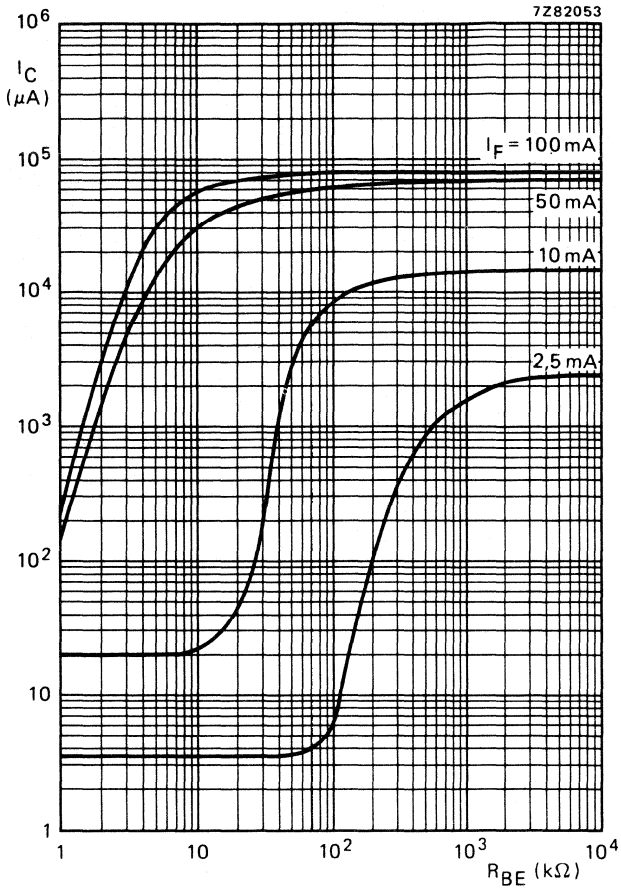

Fig. 15 CNY57A; $I_B = 0$; $V_{CE} = 5 \text{ V}$; $T_{\text{amb}} = 25 \text{ }^\circ\text{C}$; typical values.

CNY57
CNY57A

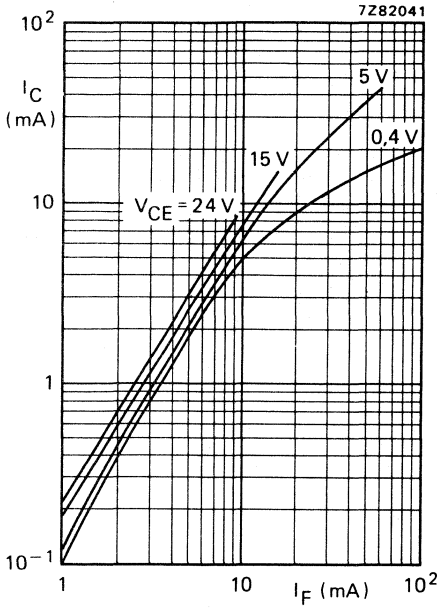

Fig. 16 CNY57; $T_{amb} = 25\text{ }^{\circ}\text{C}$; typical values.

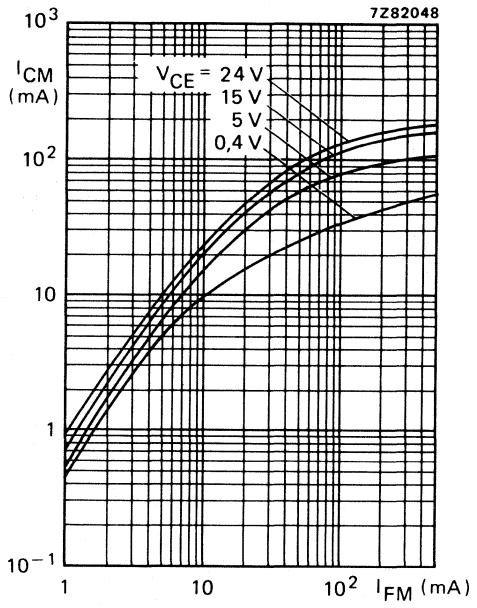

Fig. 17 CNY57A; $T_{amb} = 25\text{ }^{\circ}\text{C}$; $t_p = 10\text{ }\mu\text{s}$; $T = 1\text{ ms}$; typical values.

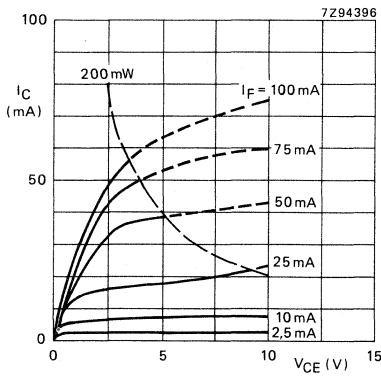

Fig. 18 CNY57; $T_{amb} = 25\text{ }^{\circ}\text{C}$; typical values.

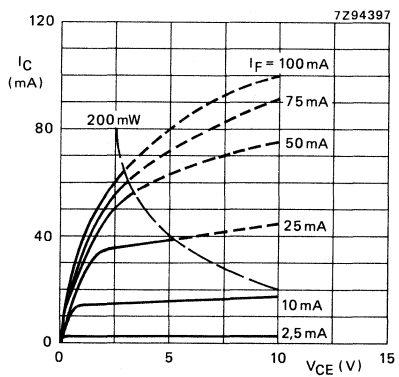

Fig. 19 CNY57A; $T_{amb} = 25\text{ }^{\circ}\text{C}$; typical values.

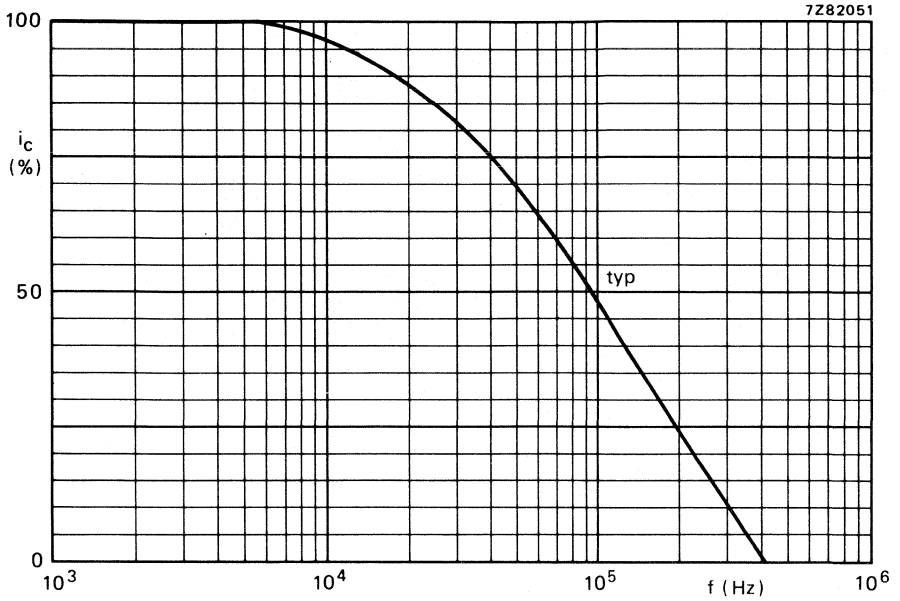

Fig. 20 $I_B = 0$; $I_C = 2$ mA; $V_{CC} = 5$ V; $R_L = 1$ k Ω ; $T_{amb} = 25$ °C.

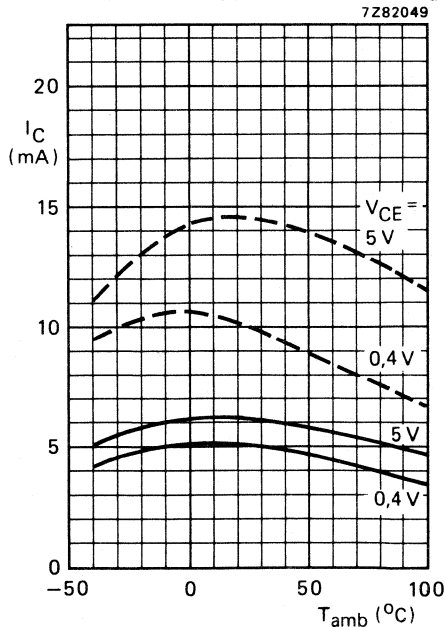

Fig. 21 — CNY57; - - - CNY57A; $I_B = 0$; $I_F = 10$ mA; typical values.

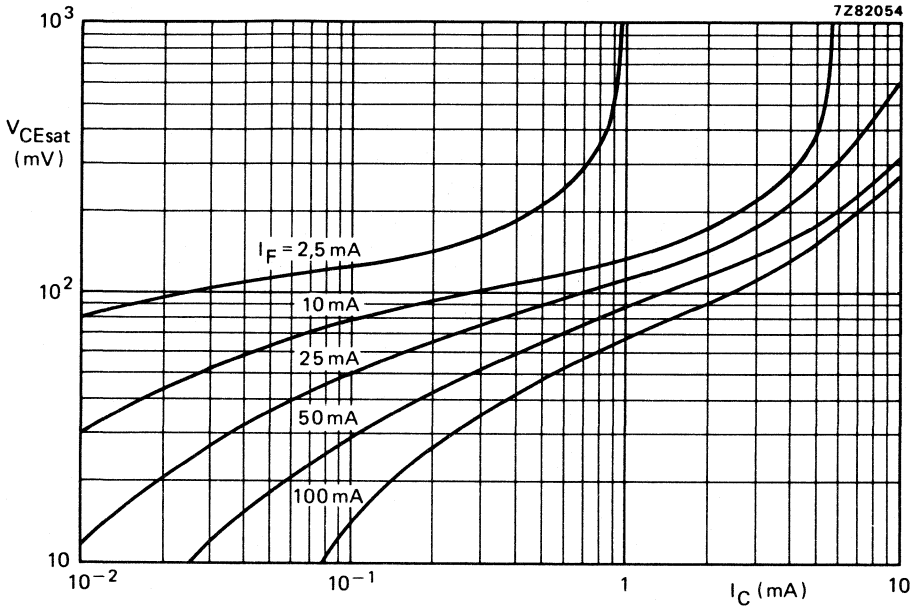

Fig. 22 CNY57; $I_B = 0$; $T_{amb} = 25^\circ\text{C}$; typical values.

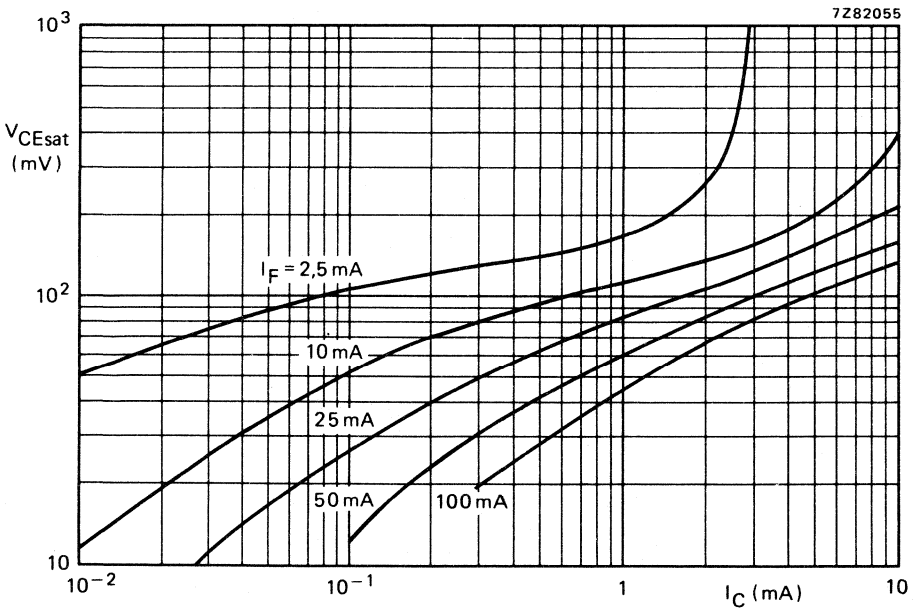

Fig. 23 CNY57A; $I_B = 0$; $T_{amb} = 25^\circ\text{C}$; typical values.

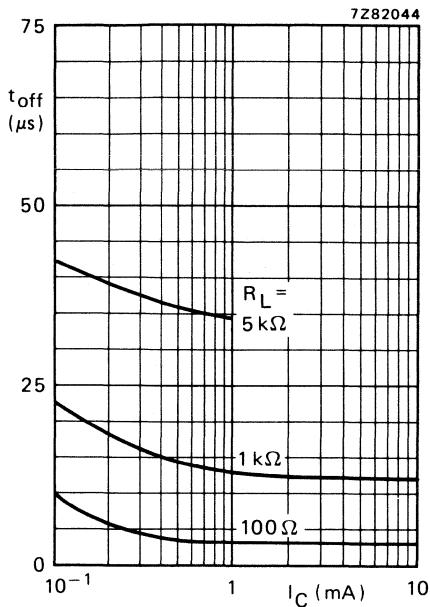
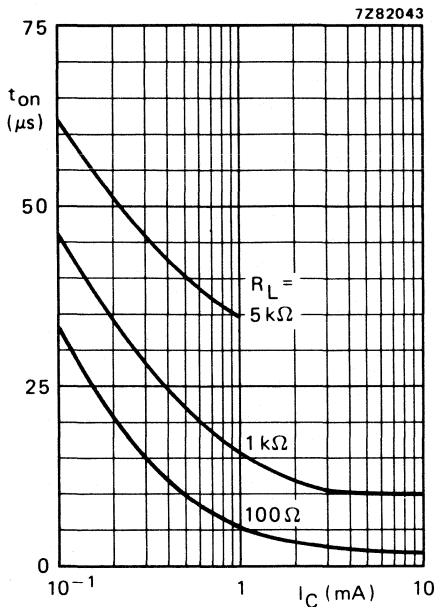
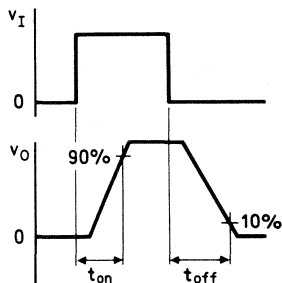
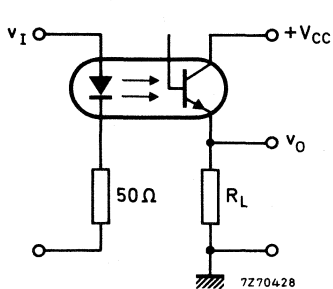

Fig. 24 CNY57; $I_B = 0$; $V_{CC} = 5\text{ V}$; $T_{amb} = 25\text{ }^\circ\text{C}$; typical values. (See also Fig. 26.)

Fig. 25 CNY57; $I_B = 0$; $V_{CC} = 5\text{ V}$; $T_{amb} = 25\text{ }^\circ\text{C}$; typical values. (See also Fig. 26.)



7Z67238.1

Fig. 26 Switching circuit and waveforms.

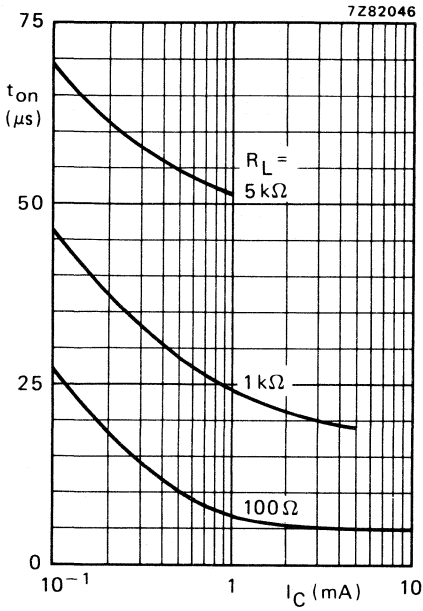

Fig. 27 CNY57A; $I_B = 0$; $V_{CC} = 5\text{ V}$; $T_{amb} = 25\text{ }^\circ\text{C}$; typical values. (See also Fig. 29.)

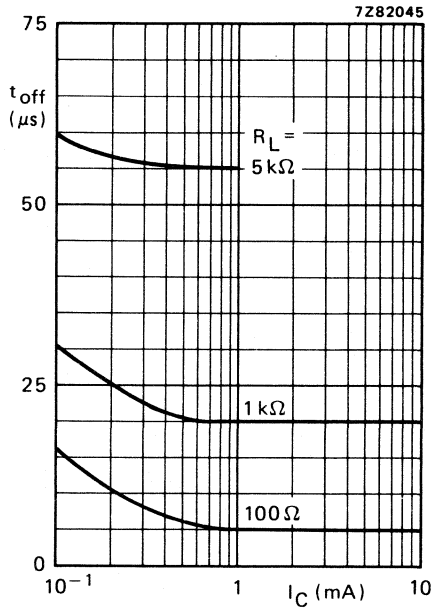

Fig. 28 CNY57A; $I_B = 0$; $V_{CC} = 5\text{ V}$; $T_{amb} = 25\text{ }^\circ\text{C}$; typical values. (See also Fig. 29.)

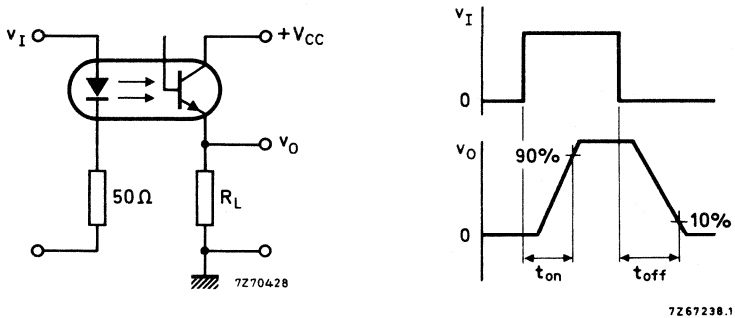

Fig. 29 Switching circuit and waveforms.

OPTOCOUPLERS

Optically coupled isolators consisting of an infrared emitting GaAs diode and a silicon n-p-n photo-transistor with accessible base. Plastic envelopes. Suitable for TTL integrated circuits.

Features of these products:

- high output/input d.c. current transfer ratio;
- low saturation voltage;
- high isolation voltage of 3,12 kV (r.m.s.) and 4,4 kV (d.c.);
- working voltage 2,5 kV (d.c.).

UL — Covered under UL component recognition FILE E90700

VDE — Approved according to VDE 0883/6.83

Complied for reinforced isolation at 250 VAC with:
DIN 57 804/VDE 0804/1.83 (isolation group C)
DIN IEC 65/VDE 0860/8.81

QUICK REFERENCE DATA

Diode

Continuous reverse voltage	V_R	max.	5 V
Forward current	I_F	max.	100 mA
d.c.	I_{FRM}	max.	3 A
(peak value); $t_p = 10 \mu s$; $\delta = 0,01$			
Total power dissipation up to $T_{amb} = 25 \text{ }^\circ\text{C}$	P_{tot}	max.	200 mW

Transistor

Collector-emitter voltage (open base)	V_{CEO}	max.	30 V
Total power dissipation up to $T_{amb} = 25 \text{ }^\circ\text{C}$	P_{tot}	max.	200 mW

Optocoupler

Output/input d.c. current transfer ratio (C.T.R.)	CNY57U CNY57AU	I_C/I_F	min.	0,2
$I_F = 10 \text{ mA}$; $V_{CE} = 0,4 \text{ V}$; ($I_B = 0$)		I_C/I_F	min.	0,4
Collector cut-off current (dark)		I_{CEW}	max.	200 nA
$V_{CC} = 10 \text{ V}$; working voltage (d.c.) = 2,5 kV		V_{IORM}	min.	4,4 kV
diode: $I_F = 0$ (see also Fig. 2)				
Isolation voltage (d.c.)				

MECHANICAL DATA

SOT-90B (see Fig. 1).

MECHANICAL DATA

Fig. 1 SOT-90B.

Dimensions in mm

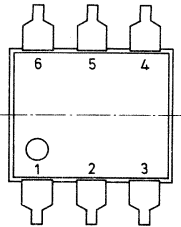
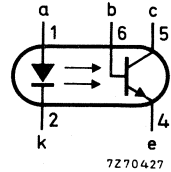
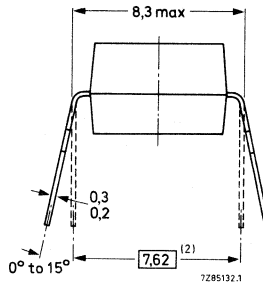
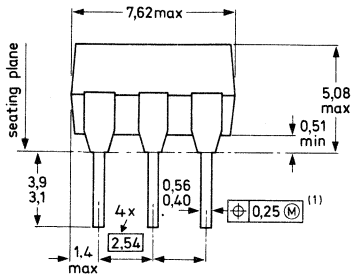

⊕ Positional accuracy.

Ⓜ Maximum material condition.

- (1) Centre-lines of all leads are within $\pm 0,125$ mm of the nominal position shown; in the worst case, the spacing between any two leads may deviate from nominal by 0,25 mm.
- (2) When the leads are parallel, the tips are in position for automatic insertion.

RATINGS

Limiting values in accordance with the Absolute Maximum System (IEC 134)

Diode

Continuous reverse voltage	V_R	max.	5 V
Forward current	I_F	max.	100 mA
d.c.	I_{FRM}	max.	3 A
(peak value); $t_p = 10 \mu s$; $\delta = 0,01$	P_{tot}	max.	200 mW
Total power dissipation up to $T_{amb} = 25 \text{ }^\circ\text{C}$	T_j	max.	125 $^\circ\text{C}$
Operating junction temperature			

Transistor

Collector-emitter voltage (open base)	V_{CEO}	max.	30 V
Collector-base voltage (open emitter)	V_{CB0}	max.	70 V
Emitter-collector voltage (open base)	V_{ECO}	max.	7 V
Collector current (d.c.)	I_C	max.	100 mA
Total power dissipation up to $T_{amb} = 25 \text{ }^\circ\text{C}$	P_{tot}	max.	200 mW
Operating junction temperature	T_j	max.	125 $^\circ\text{C}$

Photocoupler

Storage temperature	T_{stg}	-55 to +150 °C
Lead soldering temperature up to the seating plane; $t_{sld} < 10$ s	T_{sld}	max. 260 °C

THERMAL RESISTANCE

From junction to ambient in free air diode	$R_{th\ j-a}$	=	500 K/W
transistor	$R_{th\ j-a}$	=	500 K/W
From junction to ambient, device mounted on a printed-circuit board diode	$R_{th\ j-a}$	=	400 K/W
transistor	$R_{th\ j-a}$	=	400 K/W

ISOLATION RELATED VALUES

External air gap (clearance) input terminals to output terminals	$L(I01)$	min.	7,2 mm
External tracking path (creepage dist) input terminals to output terminals	$L(I02)$	min.	7,0 mm
Tracking resistance (KB-value)			KB-100/A

CHARACTERISTICS

$T_j = 25$ °C unless otherwise specified

Diode

Forward voltage $I_F = 10$ mA	V_F	typ. <	1,15 V 1,5 V
Reverse current $V_R = 5$ V	I_R	<	10 μ A

Transistor (diode: $I_F = 0$)

Collector cut-off current (dark) $V_{CE} = 10$ V	I_{CEO}	typ. <	2 nA 50 nA
$V_{CE} = 10$ V; $T_{amb} = 70$ °C	I_{CEO}	<	10 μ A
$V_{CB} = 10$ V	I_{CBO}	<	20 nA

Photocoupler ($I_B = 0$)*

Output/input d.c. current transfer ratio (C.T.R.) $I_F = 10$ mA; $V_{CE} = 0,4$ V	CNY57U	I_C/I_F	0,2 to 0,8 typ. 0,5
	CNY57AU	I_C/I_F	> 0,4 typ. 1

* Where the phototransistor receives light from the diode the O (for open base) has been omitted from the symbols.

CNY57U CNY57AU

Collector cut-off current (dark) see Fig. 2

$V_{CC} = 10\text{ V}$; working voltage (d.c.) = 2,5 kV

$V_{CC} = 10\text{ V}$; working voltage (d.c.) = 2,5 kV;

$T_j = 70\text{ }^\circ\text{C}$

$I_{CEW} < 200\text{ nA}$

$I_{CEW} < 100\text{ }\mu\text{A}$

Collector-emitter breakdown voltage

$I_C = 1\text{ mA}$

$V_{(BR)CEO}$ min. 30 30 V

Collector-base breakdown voltage

$I_C = 0,1\text{ mA}$

$V_{(BR)CBO}$ min. 70 70 V

Emitter-collector breakdown voltage

$I_E = 0,1\text{ mA}$

$V_{(BR)ECO}$ min. 7 7 V

Collector-emitter saturation voltage

$I_F = 10\text{ mA}$; $I_C = 2\text{ mA}$

V_{CEsat} typ. 0,15 — V

$V_{CEsat} < 0,4$ — V

$I_F = 10\text{ mA}$; $I_C = 4\text{ mA}$

V_{CEsat} typ. — 0,19 V

$V_{CEsat} < — 0,4\text{ V}$

Isolation voltage*

V_{IORM} min. 4,4 4,4 kV(d.c.)
3,12 3,12 kV(r.m.s.)

Capacitance between input and output

$I_F = 0$; $V = 0$; $f = 1\text{ MHz}$

C_{io} typ. 0,6 0,6 pF

Output capacitance at $F = 1\text{ MHz}$

$V_{CB} = 10\text{ V}$

C_{bc} typ. 4,5 4,5 pF

Insulation resistance between input and output

$\pm V_{IO} = 1\text{ kV}$

$r_{IO} > 10^{10}$ $10^{10}\text{ }\Omega$

typ. 10^{12} $10^{12}\text{ }\Omega$

Switching times (see Figs 3 and 4)

$I_{Con} = 2\text{ mA}$; $V_{CC} = 5\text{ V}$; $R_L = 100\text{ }\Omega$

Turn-on time

t_{on} typ. 3 — μs

Turn-off time

t_{off} typ. 3 — μs

$I_{Con} = 4\text{ mA}$; $V_{CC} = 5\text{ V}$; $R_L = 100\text{ }\Omega$

Turn-on time

t_{on} typ. — 5 μs

Turn-off time

t_{off} typ. — 5 μs

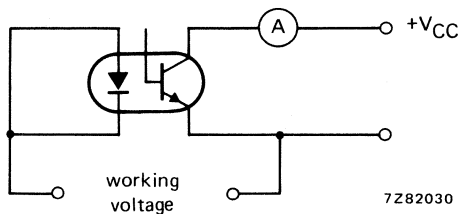

Fig. 2.

* Every single product is tested by applying an isolation test voltage of 3750 V (r.m.s.) for 2 seconds between the shorted input (diode) leads and the shorted output (phototransistor) leads.

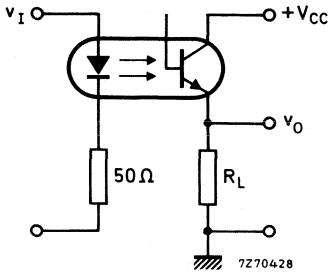

Fig. 3 Switching circuit.

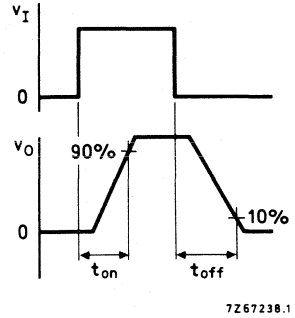

Fig. 4 Waveforms.

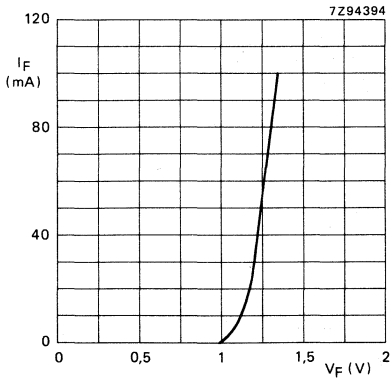

Fig. 5 $T_{amb} = 25\text{ °C}$; typical values.

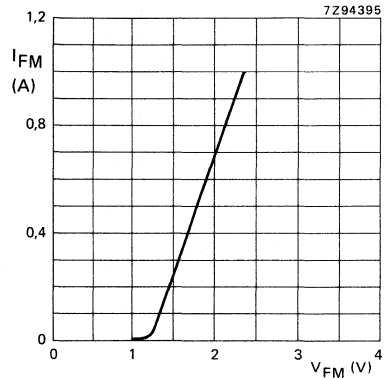

Fig. 6 $T_{amb} = 25\text{ °C}$; $t_p = 10\text{ }\mu\text{s}$; $\delta = 0,01$; typical values.

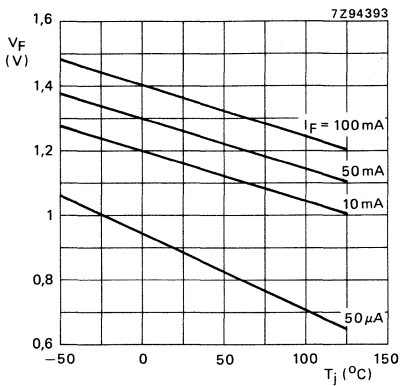

Fig. 7 Typical values.

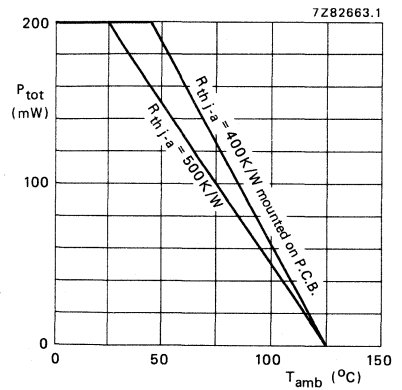

Fig. 8

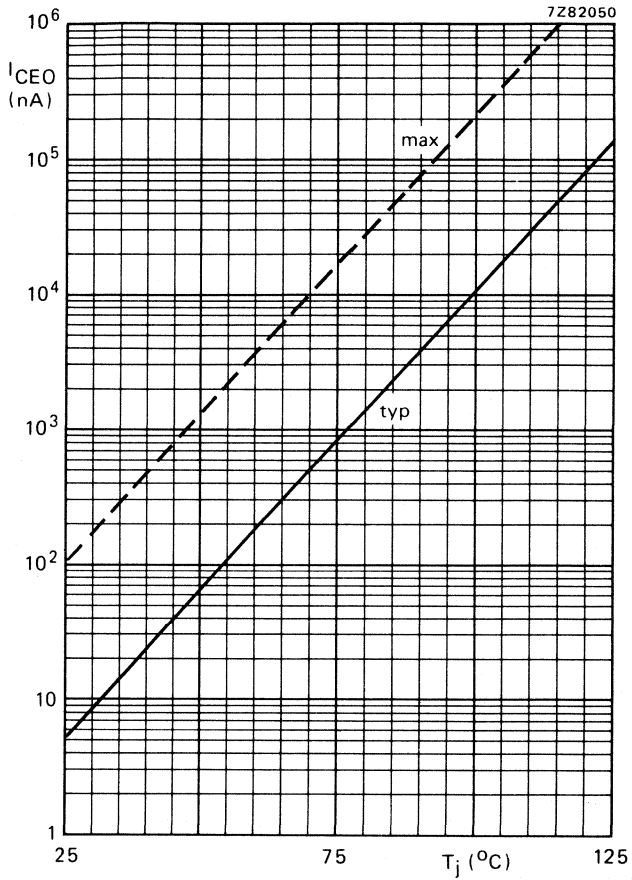

Fig. 9 $I_F = 0$; $V_{CE} = 10$ V.

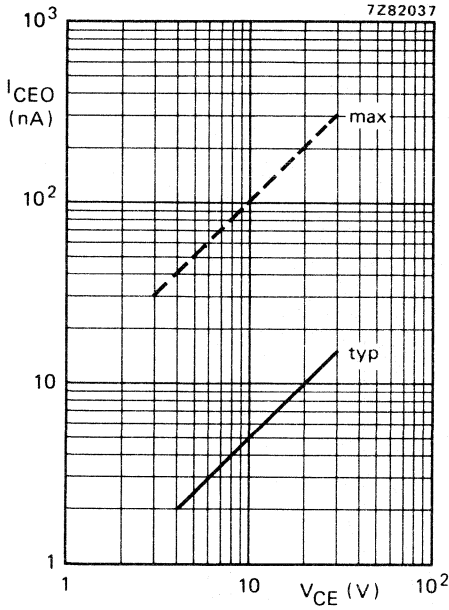

Fig. 10 $I_F = 0$; $T_j = 25^\circ\text{C}$.

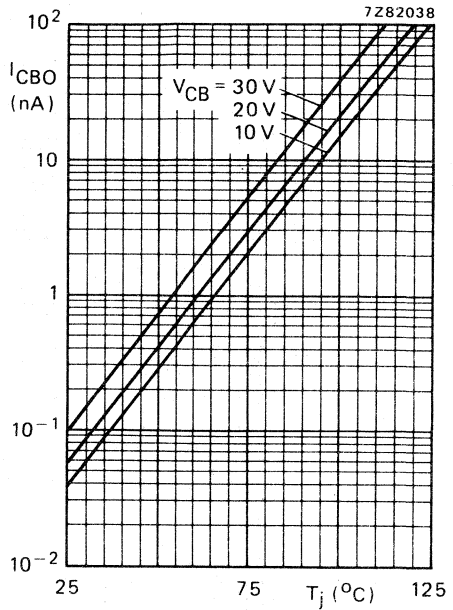

Fig. 11 $I_F = 0$; typical values.

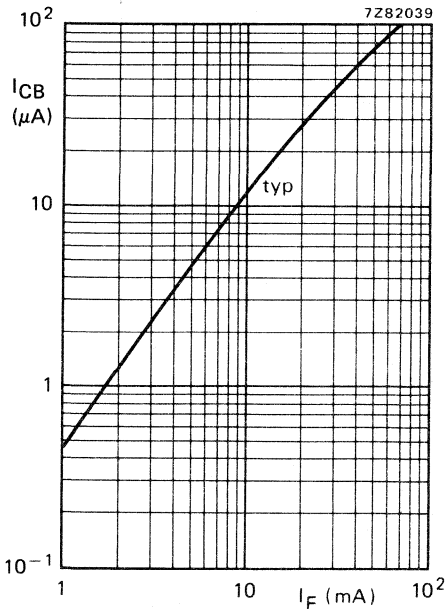

Fig. 12 $I_E = 0$; $V_{CB} = 5\text{ V}$; $T_{amb} = 25^\circ\text{C}$.

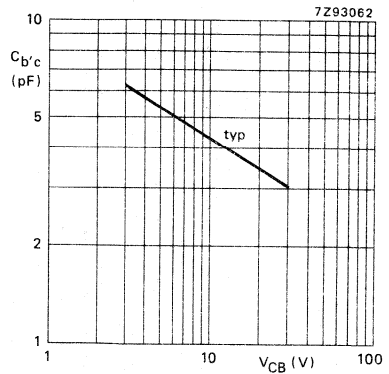

Fig. 13 $f = 1\text{ MHz}$.

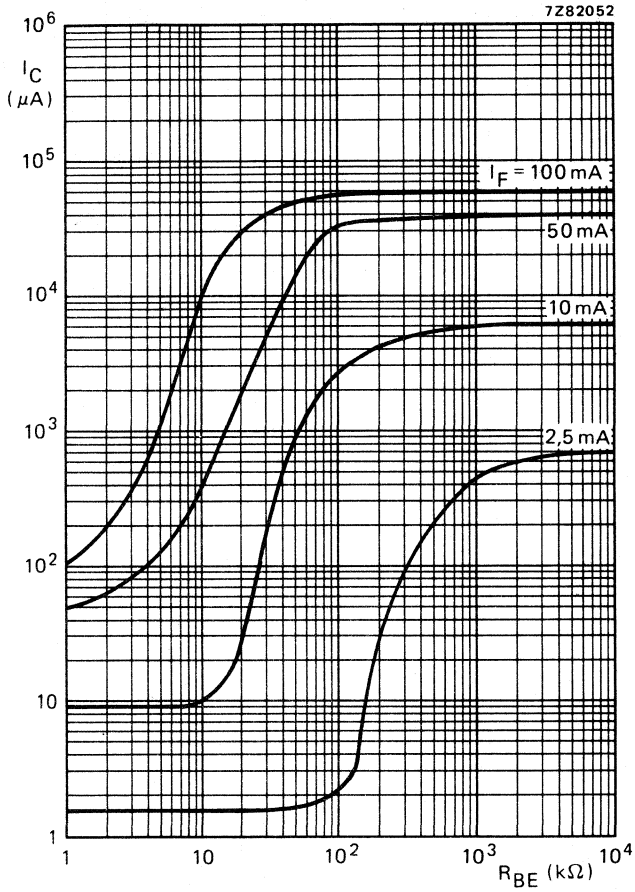

Fig. 14 CNY57U; $I_B = 0$; $V_{CE} = 5 \text{ V}$; $T_{\text{amb}} = 25 \text{ }^\circ\text{C}$; typical values.

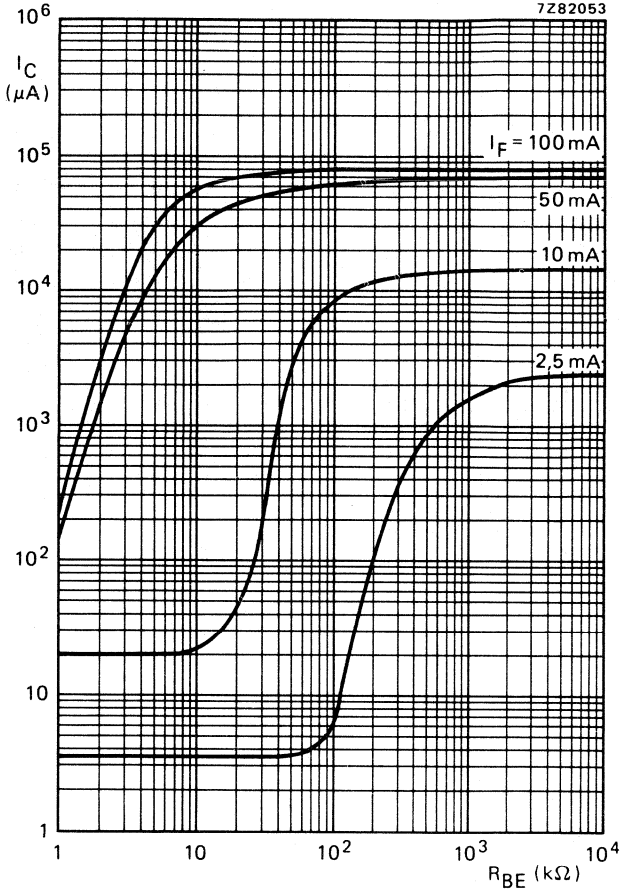

Fig. 15 CNY57AU; $I_B = 0$; $V_{CE} = 5 \text{ V}$; $T_{\text{amb}} = 25 \text{ }^\circ\text{C}$; typical values.

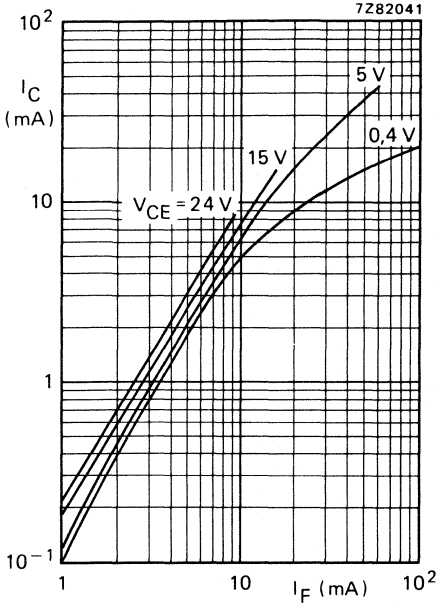

Fig. 16 CNY57U; $T_{amb} = 25\text{ }^\circ\text{C}$; typical values.

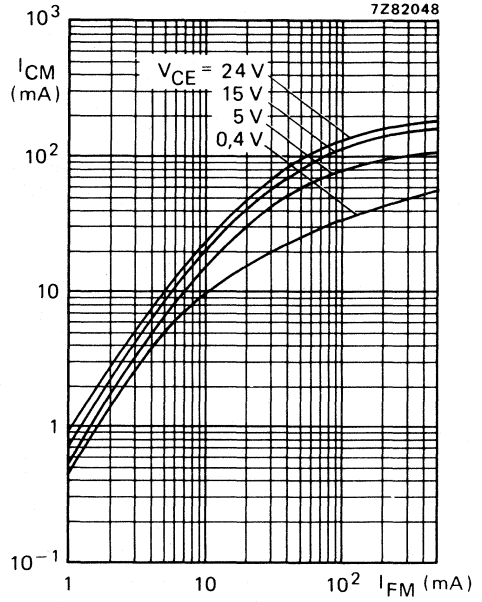

Fig. 17 CNY57AU; $T_{amb} = 25\text{ }^\circ\text{C}$; $t_p = 10\text{ }\mu\text{s}$; $T = 1\text{ ms}$; typical values.

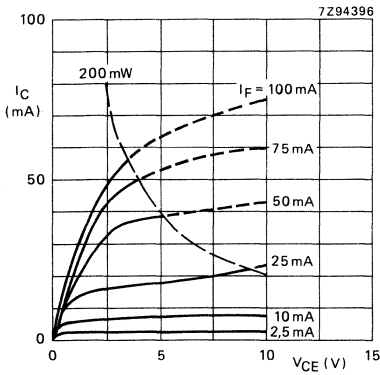

Fig. 18 CNY57U; $T_{amb} = 25\text{ }^\circ\text{C}$; typical values.

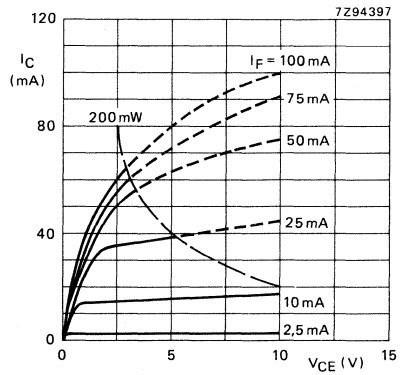

Fig. 19 CNY57AU; $T_{amb} = 25\text{ }^\circ\text{C}$; typical values.

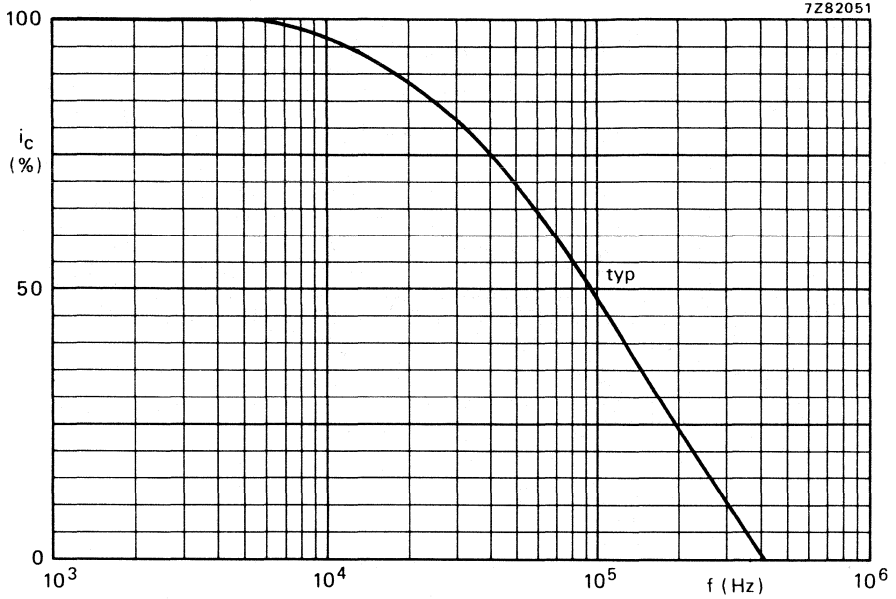

Fig. 20 $I_B = 0$; $I_C = 2$ mA; $V_{CC} = 5$ V; $R_L = 1$ k Ω ; $T_{amb} = 25$ °C.

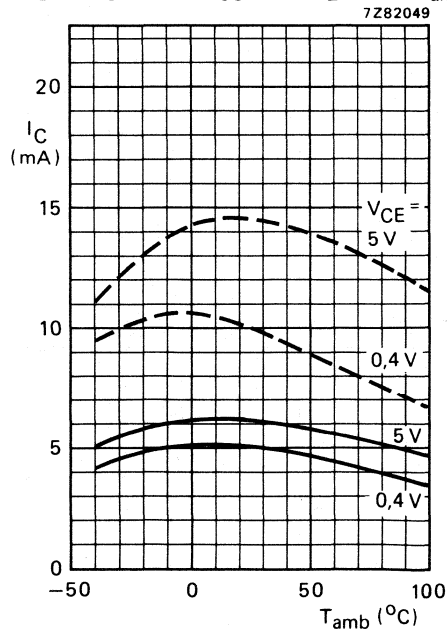

Fig. 21 — CNY57U; - - - CNY57AU; $I_B = 0$; $I_F = 10$ mA; typical values.

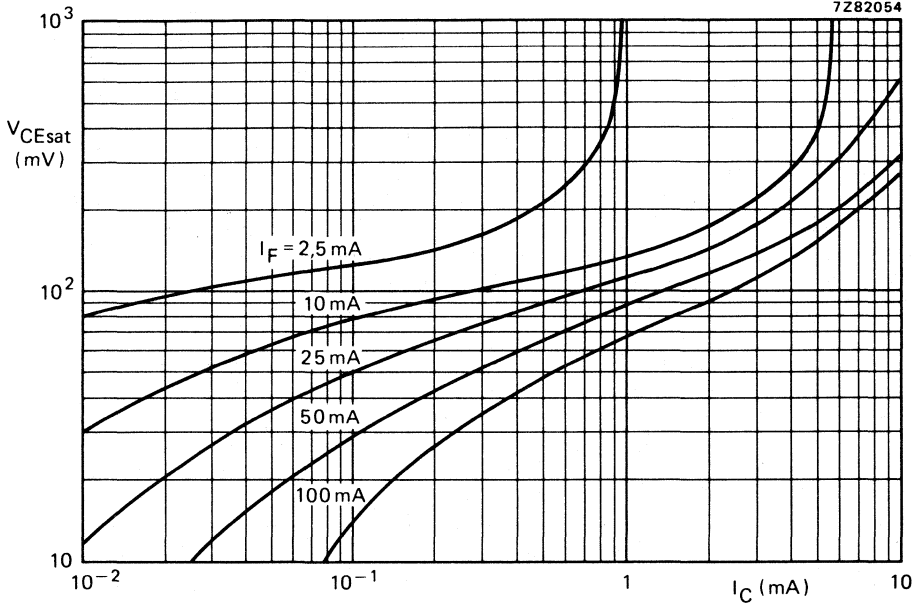

Fig. 22 CNY57U; $I_B = 0$; $T_{amb} = 25^\circ\text{C}$; typical values.

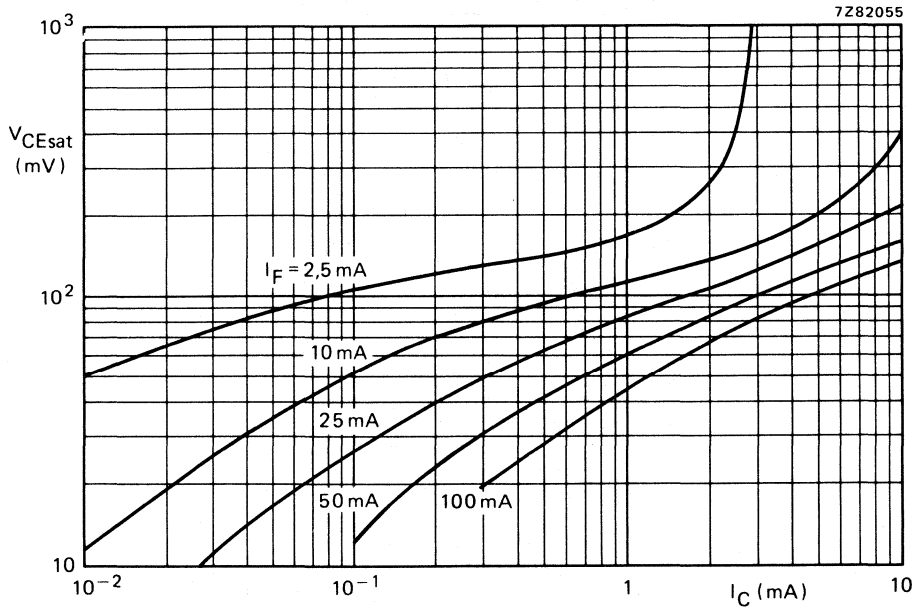

Fig. 23 CNY57AU; $I_B = 0$; $T_{amb} = 25^\circ\text{C}$; typical values.

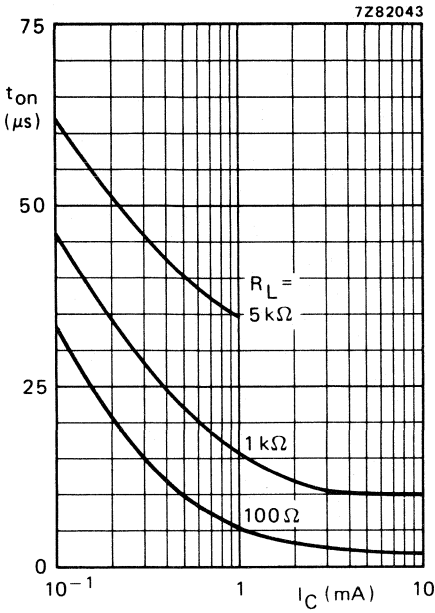

Fig. 24 CNY57U; $I_B = 0$; $V_{CC} = 5 V$;
 $T_{amb} = 25^\circ C$; typ. values. (See also Fig. 26.)

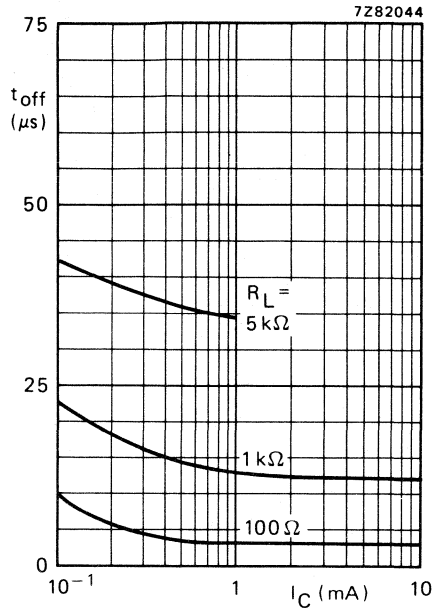

Fig. 25 CNY57U; $I_B = 0$; $V_{CC} = 5 V$;
 $T_{amb} = 25^\circ C$; typ. values. (See also Fig. 26.)

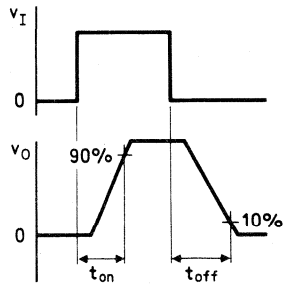
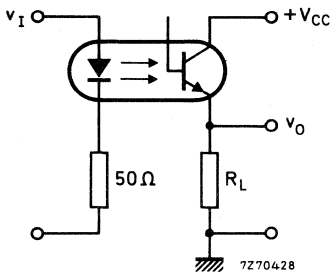

Fig. 26 Switching circuit and waveforms.

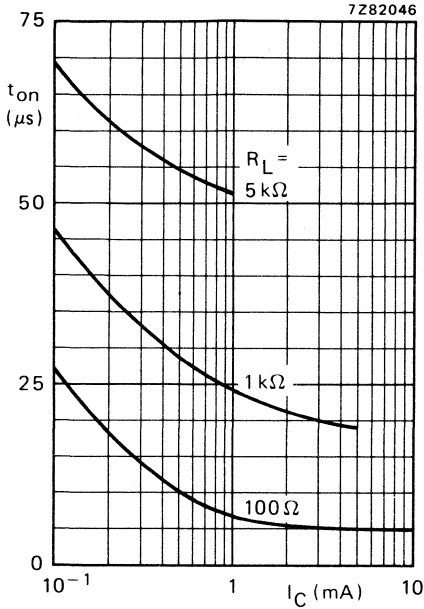

Fig. 27 CNY57AU; $I_B = 0$; $V_{CC} = 5$ V;
 $T_{amb} = 25$ °C; typ. values. (See also Fig. 29.)

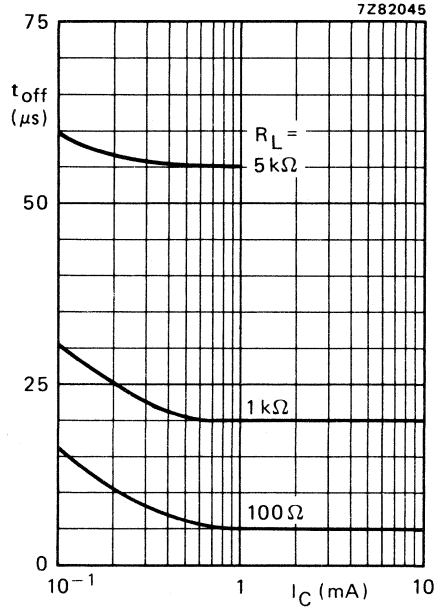

Fig. 28 CNY57AU; $I_B = 0$; $V_{CC} = 5$ V;
 $T_{amb} = 25$ °C; typ. values. (See also Fig. 29.)

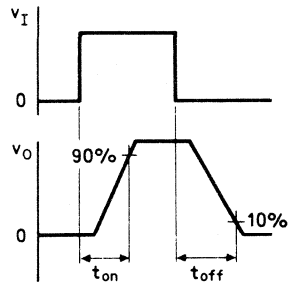
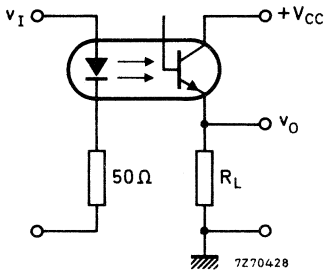

Fig. 29 Switching circuit and waveforms.

OPTOCOUPLEDERS



Optically coupled isolators consisting of an infrared emitting GaAs diode and a silicon n-p-n photo-transistor without accessible base. Plastic envelopes. Suitable for TTL integrated circuits.

Features of these products:

- high output/input d.c. current transfer ratio;
- low saturation voltage;
- a high isolation voltage
CNY62 3,75 kV (r.m.s.) and 5,3 kV (d.c.);
CNY63 3 kV (r.m.s.) and 4,3 kV (d.c.);
- working voltage 1,5 kV.

QUICK REFERENCE DATA

Diode		CNY62		CNY63	
Continuous reverse voltage	V_R	max.	5	5 V	
Forward current					
d.c.	I_F	max.	100	100 mA	
(peak value); $t_p = 10 \mu s$; $\delta = 0,1$	I_{FRM}	max.	1000	1000 mA	
Total power dissipation up to $T_{amb} = 25 \text{ }^\circ\text{C}$	P_{tot}	max.	150	150 mW	
Transistor					
Collector-emitter voltage (open base)	V_{CEO}	max.	50	30 V	
Total power dissipation up to $T_{amb} = 25 \text{ }^\circ\text{C}$	P_{tot}	max.	200	200 mW	
Optocoupler					
Output/input d.c. current transfer ratio (C.T.R.)					
$I_F = 10 \text{ mA}$; $V_{CE} = 0,4 \text{ V}$; ($I_B = 0$)	I_C/I_F	min.	0,25	0,50	
Collector cut-off current (dark)					
$V_{CC} = 10 \text{ V}$; working voltage (d.c.) = 1,5 kV diode: $I_F = 0$ (see also Fig. 2)	I_{CEW}	max.	200	200 nA	
Isolation voltage (d.c.)	V_{IORM}	min.	5,3	4,3 kV	

MECHANICAL DATA

SOT-91B (see Fig. 1).

MECHANICAL DATA

Dimensions in mm

Fig. 1 SOT-91B.

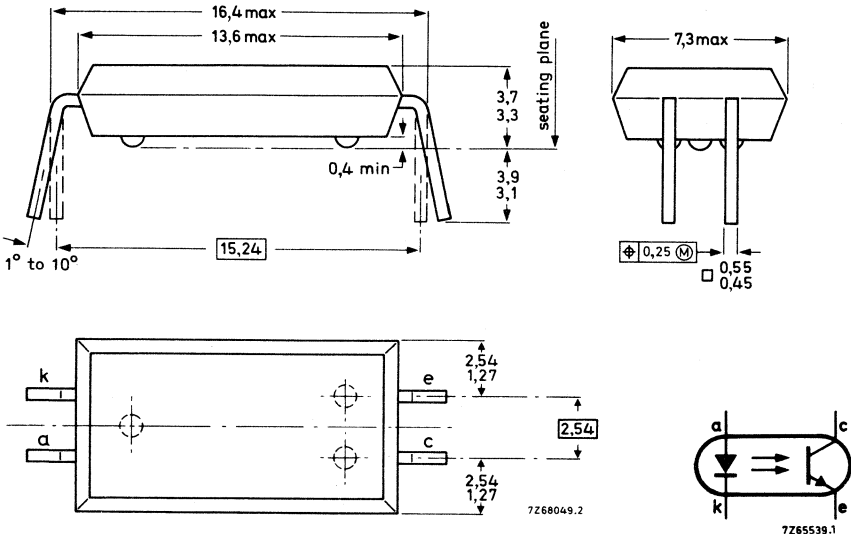

- \oplus Positional accuracy.
- \textcircled{M} Maximum material condition.

RATINGS

Limiting values in accordance with the Absolute Maximum System (IEC 134)

Diode

Continuous reverse voltage	V_R	max.	5 V
Forward current	I_F	max.	100 mA
d.c.	I_{FRM}	max.	1000 mA
→ (peak value); $t_p = 10 \mu s$; $\delta = 0,1$	P_{tot}	max.	150 mW
Total power dissipation up to $T_{amb} = 25 \text{ }^\circ\text{C}$	T_j	max.	125 $^\circ\text{C}$
Operating junction temperature			

Transistor

Collector-emitter voltage (open base)	CNY62	V_{CE0}	max.	50 V
	CNY63	V_{CE0}	max.	30 V
Emitter-collector voltage (open base)		V_{ECO}	max.	7 V
Collector current (d.c.)		I_C	max.	100 mA

Total power dissipation up to $T_{amb} = 25\text{ }^{\circ}\text{C}$	P_{tot}	max.	200 mW
Operating junction temperature	T_j	max.	125 $^{\circ}\text{C}$

Optocoupler

Storage temperature	T_{stg}	-55 to +150 $^{\circ}\text{C}$
Lead soldering temperature up to the seating plane; $t_{sld} < 10\text{ s}$	T_{sld}	max. 260 $^{\circ}\text{C}$

THERMAL RESISTANCE

From junction to ambient in free air diode	$R_{th\ j-a}$	=	650 K/W	←
transistor	$R_{th\ j-a}$	=	500 K/W	

From junction to ambient, device mounted on a printed-circuit board diode	$R_{th\ j-a}$	=	600 K/W	←
transistor	$R_{th\ j-a}$	=	400 K/W	

CHARACTERISTICS

$T_j = 25\text{ }^{\circ}\text{C}$ unless otherwise specified

Diode

Forward voltage $I_F = 10\text{ mA}$	V_F	typ. <	1,2 V 1,5 V
Reverse current $V_R = 5\text{ V}$	I_R	<	10 μA

Transistor (diode: $I_F = 0$)

Collector cut-off current (dark) $V_{CE} = 10\text{ V}$	I_{CEO}	typ. <	5 nA 100 nA
$V_{CE} = 10\text{ V}; T_{amb} = 70\text{ }^{\circ}\text{C}$	I_{CEO}	<	10 μA

Collector-emitter breakdown voltage $I_C = 1\text{ mA}$	CNY62 CNY63	$V_{(BR)\ CEO}$	min min	50 V 30 V
--	----------------	-----------------	------------	--------------

Emitter-collector breakdown voltage $I_E = 0,1\text{ mA}$	CNY62 CNY63	$V_{(BR)\ CEO}$	min min	7V 7V
--	----------------	-----------------	------------	----------

Optocoupler ($I_B = 0$)*

Output/input d.c. current transfer ratio (C.T.R.) $I_F = 10\text{ mA}; V_{CE} = 0,4\text{ V}$	CNY62	I_C/I_F	> typ.	0,25 0,50	←
	CNY63	I_C/I_F	> typ.	0,5 1,0	

Collector cut-off current (dark) see Fig. 2 $V_{CC} = 10\text{ V};$ working voltage (d.c.) = 1,5 kV	I_{CEW}	<	200 nA
$V_{CC} = 10\text{ V};$ working voltage (d.c.) = 1,5 kV; $T_j = 70\text{ }^{\circ}\text{C}$	I_{CEW}	<	100 μA

* Where the phototransistor receives light from the diode the O (for open base) has been omitted from the symbols.

CNY62
CNY63

Collector-emitter saturation voltage

$I_F = 10 \text{ mA}; I_C = 2 \text{ mA}$

$I_F = 10 \text{ mA}; I_C = 4 \text{ mA}$

Isolation voltage; $t = 1 \text{ min}$

Capacitance between input and output

$I_F = 0; V = 0; f = 1 \text{ MHz}$

Insulation resistance between input and output

$\pm V_{IO} = 1 \text{ kV}$

Switching times (see Fig. 19)

$I_{Con} = 2 \text{ mA}; V_{CC} = 5 \text{ V}; R_L = 100 \Omega$

Turn-on time

Turn-off time

$I_{Con} = 4 \text{ mA}; V_{CC} = 5 \text{ V}; R_L = 100 \Omega$

Turn-on time

Turn-off time

		CNY62	CNY63
V_{CEsat}	typ.	0,17	— V
	<	0,40	— V
V_{CEsat}	typ.	—	0,17 V
	<	—	0,40 V
V_{IORM}	min.	5,3	4,3 kV(d.c.)
	min.	3,75	3 kV(r.m.s.)
C_{io}	typ.	0,6	0,6 pF
r_{IO}	>	10^{10}	$10^{10} \Omega$
	typ.	10^{12}	$10^{12} \Omega$
t_{on}	typ.	3	— μs
	typ.	3	— μs
t_{off}	typ.	—	5 μs
	typ.	—	5 μs

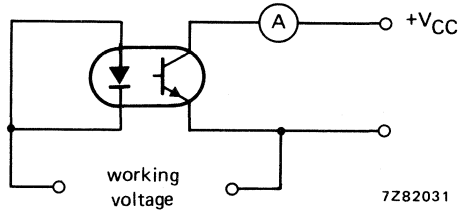

Fig. 2.

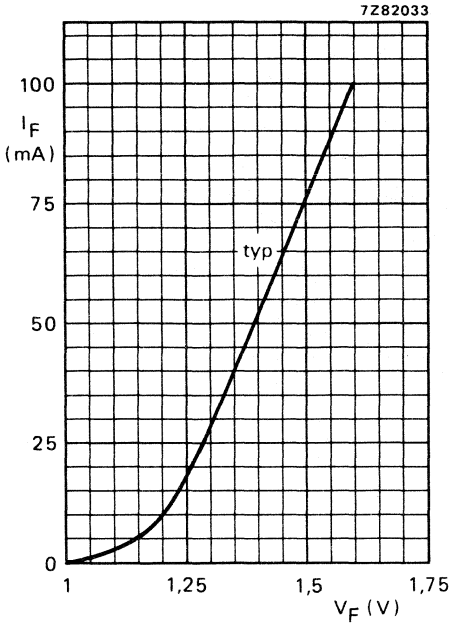

Fig. 3 $T_{amb} = 25^{\circ}C$.

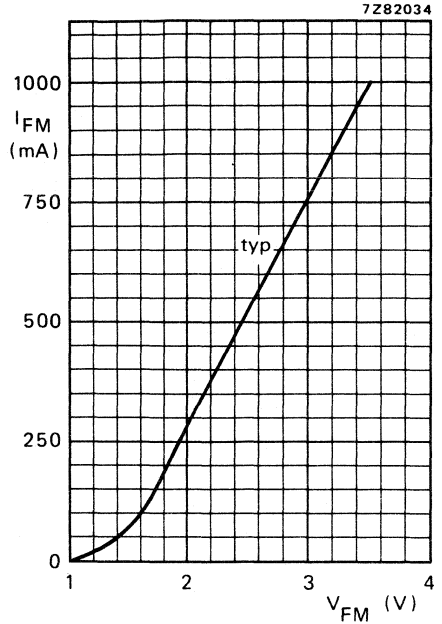

Fig. 4 $T_{amb} = 25^{\circ}C$; $t_p = 10 \mu s$; $T = 1 ms$.

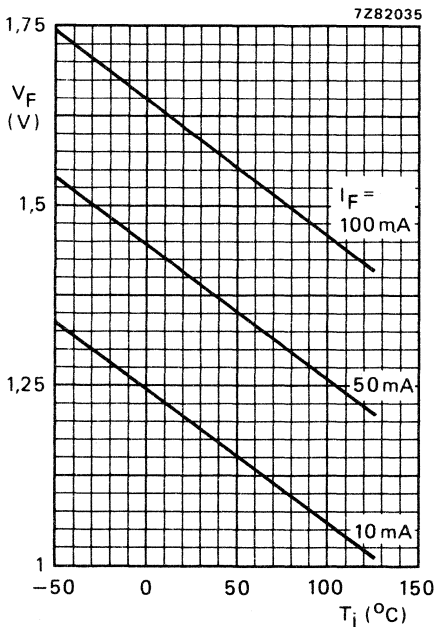

Fig. 5 Typical values.

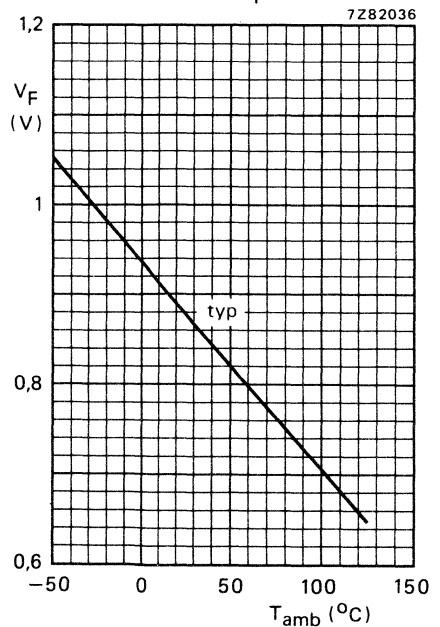

Fig. 6 $I_F = 50 \mu A$.

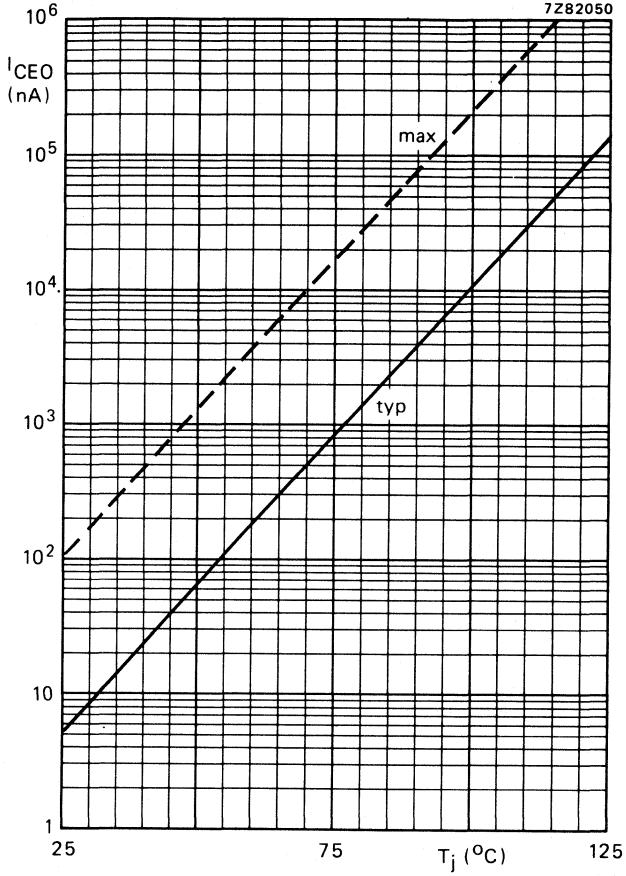

Fig. 7 $I_F = 0$; $V_{CE} = 10$ V.

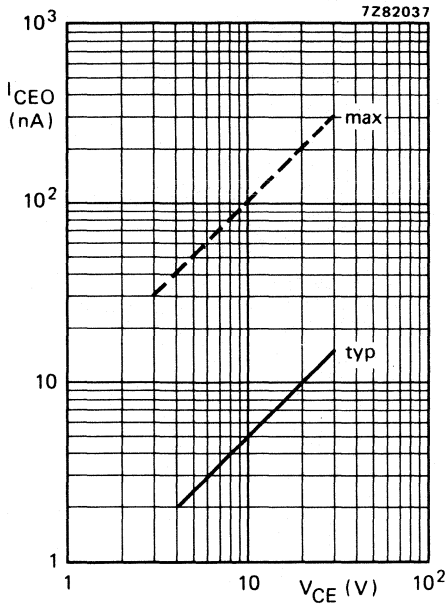

Fig. 8 $I_F = 0$; $T_j = 25^\circ\text{C}$.

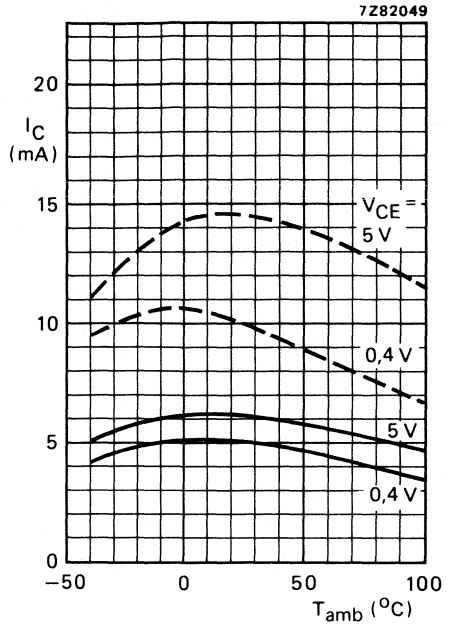

Fig. 9 $I_B = 0$; $I_F = 10\text{ mA}$;
— CNY62; --- CNY63; typical values.

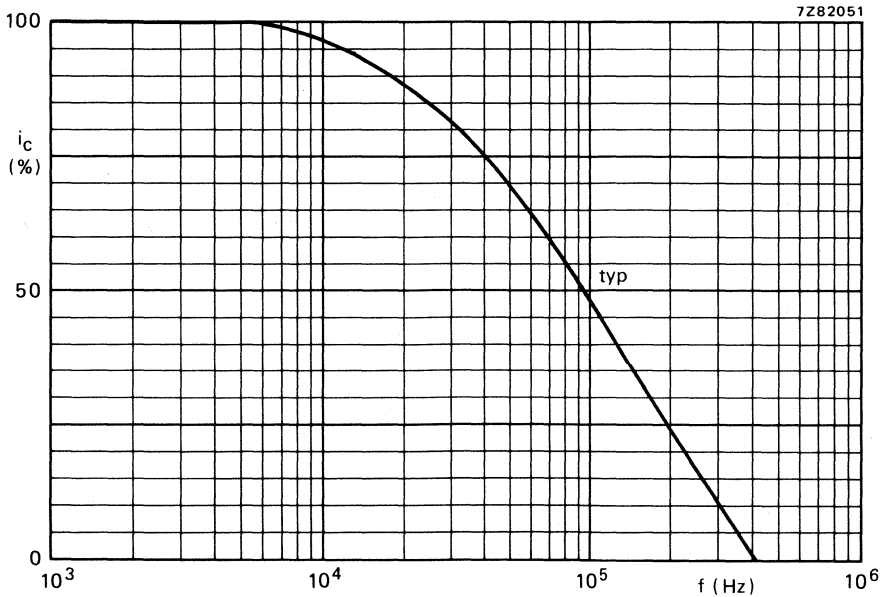

Fig. 10 $I_B = 0$; $I_C = 2\text{ mA}$; $V_{CC} = 5\text{ V}$; $R_L = 1\text{ k}\Omega$; $T_{\text{amb}} = 25^\circ\text{C}$.

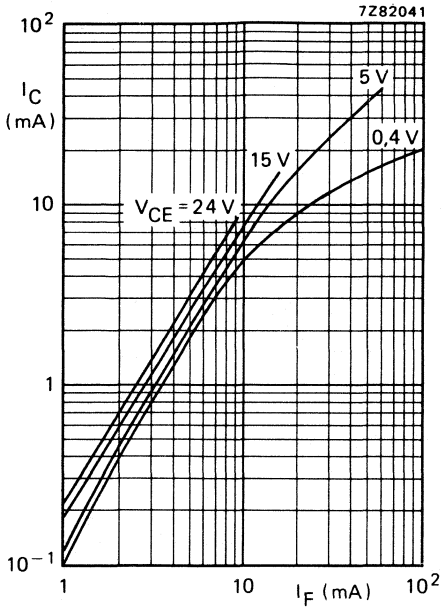

Fig. 11 CNY62; $T_{amb} = 25\text{ }^{\circ}\text{C}$; typical values.

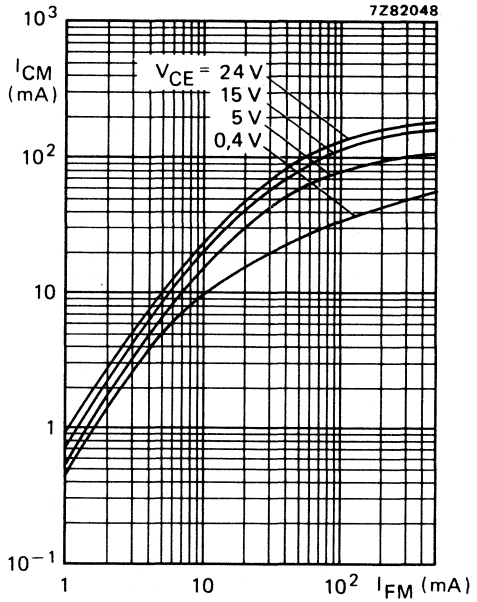

Fig. 12 CNY63; $T_{amb} = 25\text{ }^{\circ}\text{C}$; $t_p = 10\text{ }\mu\text{s}$; $T = 1\text{ ms}$; typical values.

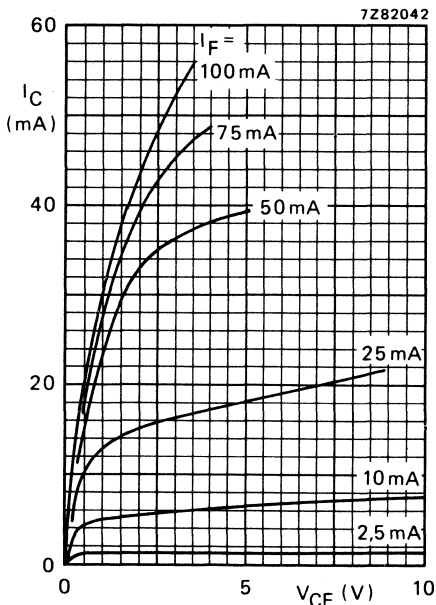

Fig. 13 CNY62; $T_{amb} = 25\text{ }^{\circ}\text{C}$; typical values.

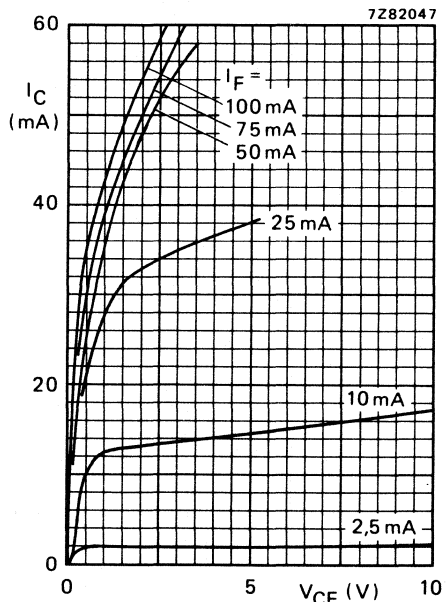

Fig. 14 CNY63; $T_{amb} = 25\text{ }^{\circ}\text{C}$; typical values.

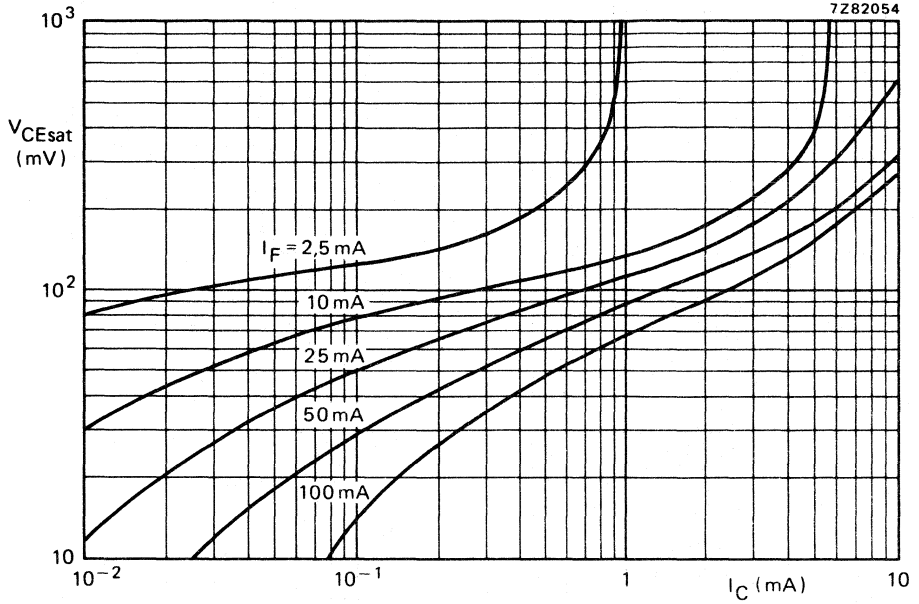

Fig. 15 CNY62; $I_B = 0$; $T_{amb} = 25^\circ\text{C}$; typical values.

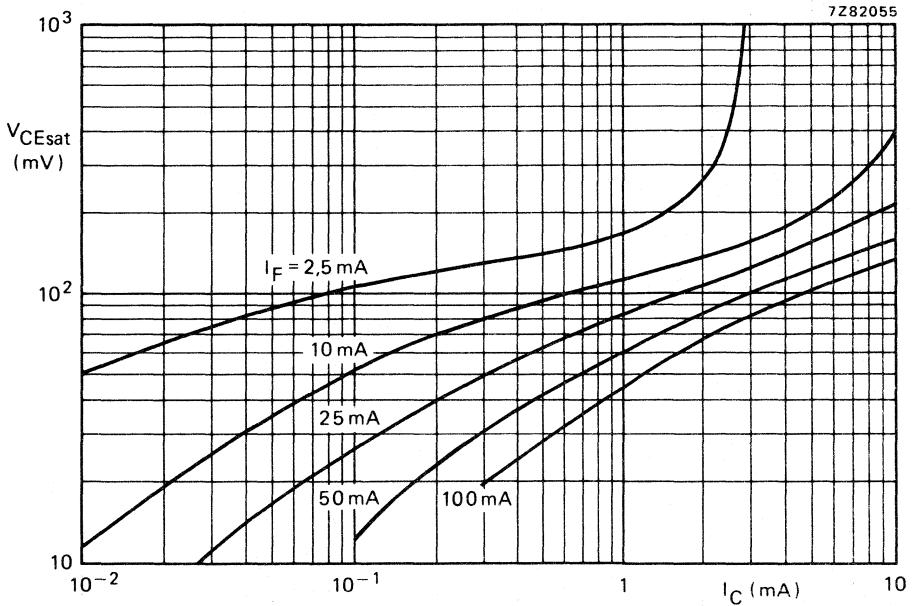

Fig. 16 CNY63; $I_B = 0$; $T_{amb} = 25^\circ\text{C}$; typical values.

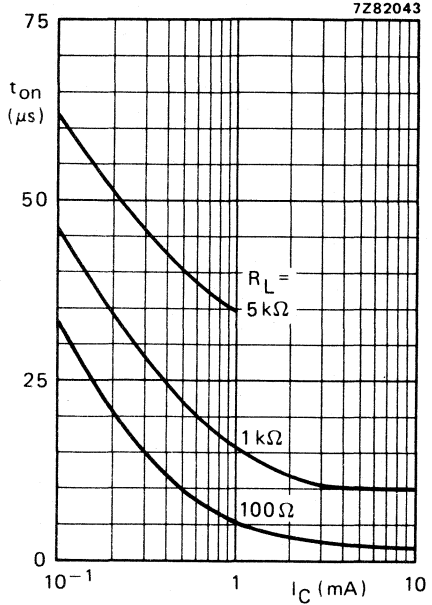

Fig. 17 CNY62; $I_B = 0$; $V_{CC} = 5$ V;
 $T_{amb} = 25$ °C; typical values.
(See also Fig. 19).

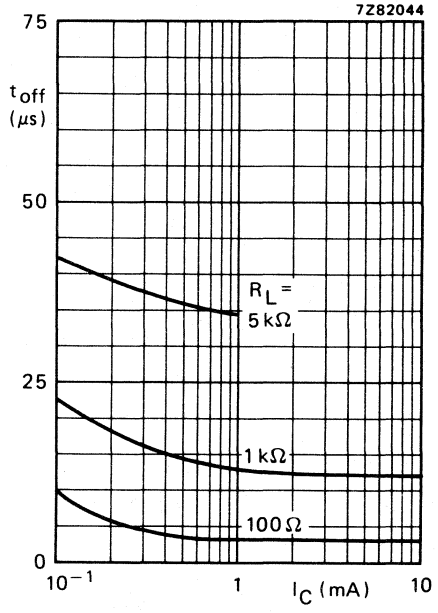

Fig. 18 CNY62; $I_B = 0$; $V_{CC} = 5$ V;
 $T_{amb} = 25$ °C; typical values.
(See also Fig. 19).

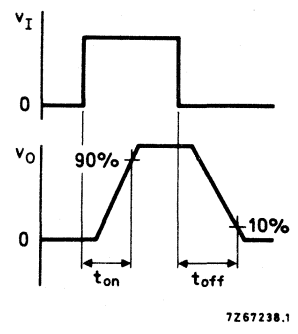
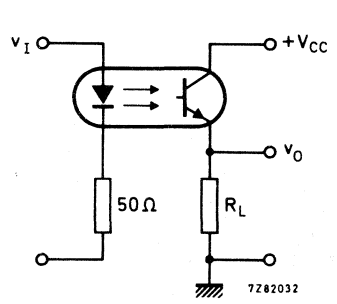

Fig. 19 Switching circuit and waveforms.

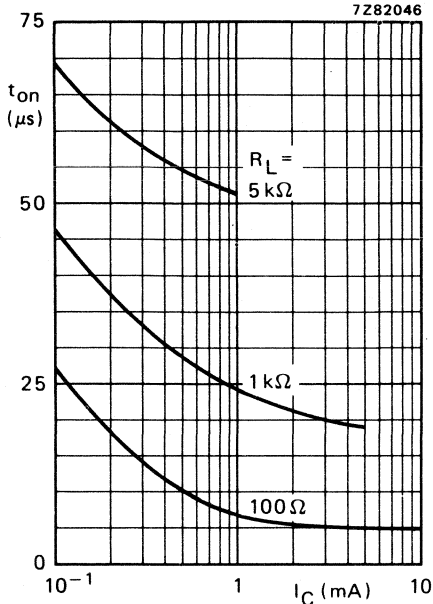

Fig. 20 CNY63; $I_B = 0$; $V_{CC} = 5\text{ V}$;
 $T_{amb} = 25\text{ }^\circ\text{C}$; typical values.
(See also Fig. 22).

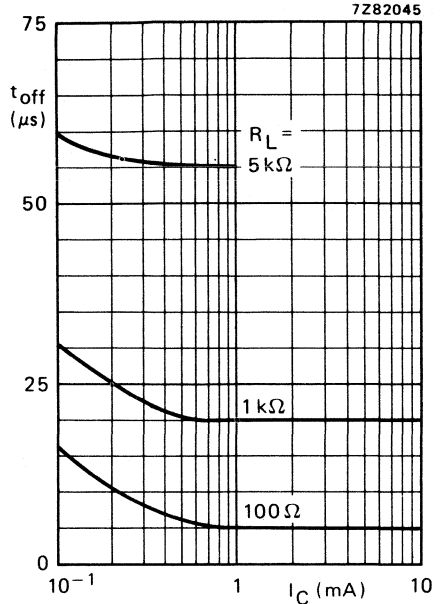
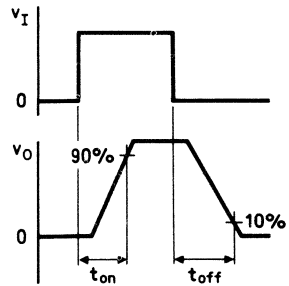
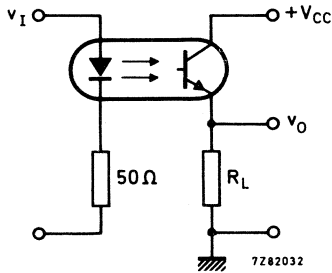

Fig. 21 CNY63; $I_B = 0$; $V_{CC} = 5\text{ V}$;
 $T_{amb} = 25\text{ }^\circ\text{C}$; typical values.
(See also Fig. 22).



7Z67238.1

Fig. 22 Switching circuit and waveforms.

OPTOCOUPERS

This product range is one of the industrial standards applied in the market. The current transfer ratio, isolation voltage and low saturation voltage comply to the specifications of the main part of the optocoupler market.

This range can be used with TTL circuits and is comprised of an infrared emitting GaAs diode and an N-P-N silicon phototransistor.

UL — Covered under UL component recognition FILE E90700

VDE — Approved according to VDE 0883/6.83

QUICK REFERENCE DATA

Collector-emitter voltage of phototransistor	V_{CEO}	max.	30 V
Forward current of infrared emitting diode (d.c.)	I_F	max.	60 mA
D.C. current transfer ratio at $I_F = 10 \text{ mA}; V_{CE} = 10 \text{ V}$	H11A1	I_C/I_F min.	0,5
	H11A2	I_C/I_F min.	0,2
	H11A3	I_C/I_F min.	0,2
	H11A4	I_C/I_F min.	0,1
Total power dissipation up to $T_{amb} = 25 \text{ }^\circ\text{C}$	P_{tot}	max.	250 mW
Isolation voltage (d.c.)	V_{IORM}	min.	2 kV (r.m.s.)

MECHANICAL DATA

SOT-90B (see Fig. 1).

MECHANICAL DATA

Fig. 1 SOT-90B.

Dimensions in mm

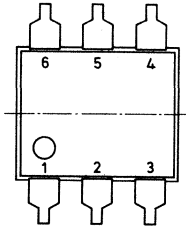
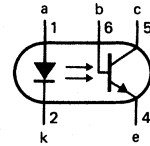
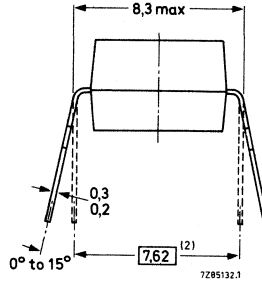
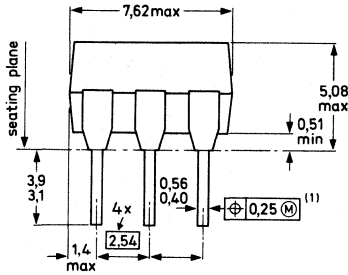

⊕ Positional accuracy.

Ⓜ Maximum Material Condition.

(1) Centre-lines of all leads are within $\pm 0,125$ mm of the nominal position shown; in the worst case, the spacing between any two leads may deviate from nominal by 0,25 mm.

(2) When the leads are parallel, the tips remain in position for automatic insertion.

RATINGS

Limiting factors in accordance with the Absolute Maximum System (IEC 134)

Diode

Continuous reverse voltage	V_R	max.	5 V
Forward current			
d.c.	I_F	max.	60 mA
peak value; $t_{on} = 10 \mu s$; $\delta = 0,01$	I_{FRM}	max.	3 A
Total power dissipation			
up to $T_{amb} = 25 \text{ }^\circ\text{C}$	P_{tot}	max.	100 mW

Transistor

Collector-emitter voltage (open base)	V_{CEO}	max.	30 V
Collector-base voltage (open emitter)	V_{CBO}	max.	70 V
Emitter-collector voltage (open base)	V_{ECO}	max.	7 V
Collector current (d.c.)	I_C	max.	100 mA
Total power dissipation			
up to $T_{amb} = 25 \text{ }^\circ\text{C}$	P_{tot}	max.	150 mW

Optocoupler

Storage temperature	T_{stg}	-55 to +150 °C
Operating junction temperature	T_j	-55 to +100 °C
Operating temperature up to the seating plane; $t_{sld} < 10$ s	T_{sld}	max. 260 °C
Total power dissipation up to $T_{amb} = 25$ °C	P_{tot}	max. 250 mW

THERMAL RESISTANCE

From junction to ambient in free air diode	$R_{th\ j-a}$	max. 500 K/W
transistor	$R_{th\ j-a}$	max. 500 K/W

LINEAR DERATING FACTORS

Above 25 °C		
diode		1,33 mW/K
transistor		2 mW/K

ISOLATION RELATED VALUES

External air gap (clearance) input terminals to output terminals	$L(I01)$	min. 7,2 mm
External tracking path (creepage distance) input terminals to output terminals	$L(I02)$	min. 7,0 mm
Tracking resistance (KB-value)		KB-100/A

CHARACTERISTICS

$T_j = 25$ °C unless otherwise specified

Diode

Forward voltage $I_F = 10$ mA	V_F	typ. 1,15 V max. 1,5 V
Reverse current $V_R = 5$ V	I_R	max. 10 μ A
Capacitance at $f = 1$ MHz $V = 0$	C_d	typ. 50 pF

Transistor

Collector-emitter breakdown voltage $I_C = 10$ mA	$V_{(BR)CEO}$	min. 30 V
Collector-base breakdown voltage $I_C = 0,1$ mA	$V_{(BR)CBO}$	min. 70 V
Emitter-collector breakdown voltage $I_E = 0,1$ mA	$V_{(BR)ECO}$	min. 7 V
Dark current $V_{CE} = 10$ V	I_{CEO}	typ. 2 nA max. 50 nA

Optocoupler

Output/input d.c. current transfer ratio

$I_F = 10 \text{ mA}; V_{CE} = 10 \text{ V}$

H11A1	I_C/I_F	min.	0,5
H11A2, H11A3	I_C/I_F	min.	0,2
H11A4	I_C/I_F	min.	0,1

Collector-emitter saturation voltage

$I_F = 10 \text{ mA}; I_C = 0,5 \text{ mA}$

V_{CEsat}	max.	0,4 V
	typ.	0,1 V

Output capacitance at $f = 1 \text{ MHz}$

$V_{CE} = 10 \text{ V}$

C_{CE}	typ.	2 pF
----------	------	------

Isolation voltage *

V_{IORM}	min.	2 kV (r.m.s.) 2,82 kV (d.c.)
------------	------	---------------------------------

Capacitance between input and output

$V = 0; f = 1 \text{ MHz}$

C_{io}	max.	2 pF
----------	------	------

Insulation resistance between input and output

$V_{IO} = 500 \text{ V}$

R_{IO}	min.	$10^{11} \Omega$
----------	------	------------------

Rise time

$I_C = 2 \text{ mA}; V_{CC} = 10 \text{ V}; R_L = 100 \Omega$

t_r	typ.	3 μs
-------	------	-----------------

Fall time

$I_C = 2 \text{ mA}; V_{CC} = 10 \text{ V}; R_L = 100 \Omega$

t_f	typ.	3 μs
-------	------	-----------------

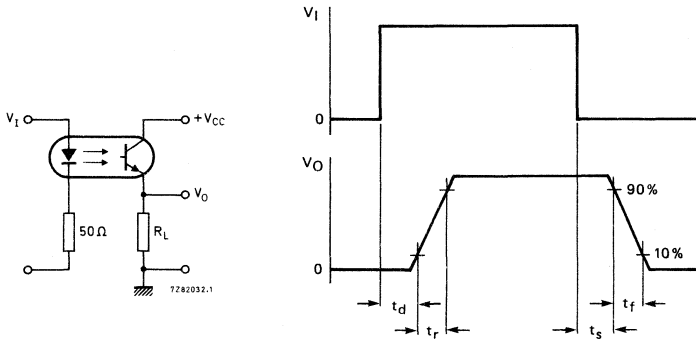

7294445

Fig. 2 Measuring circuit and waveforms.

* Every single product is tested by applying an isolation test voltage of 2500 V (r.m.s.) for 2 seconds between the shorted input (diode) leads and the shorted output (phototransistor) leads.

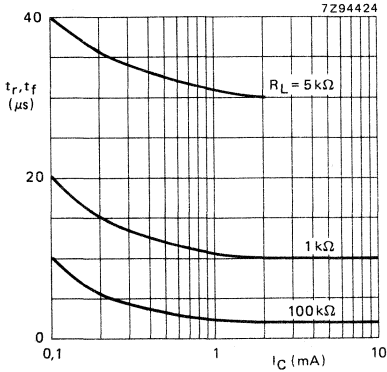

Fig. 3 $V_{CC} = 10\text{ V}$; $T_{amb} = 25\text{ }^\circ\text{C}$; typical values.

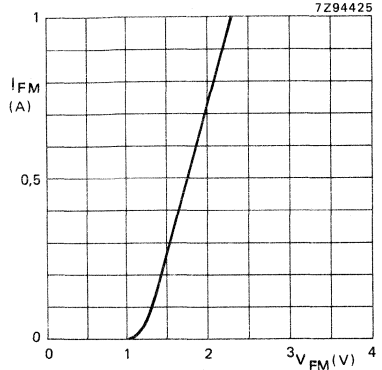

Fig. 4 $T_{amb} = 25\text{ }^\circ\text{C}$; $t_{on} = 20\text{ }\mu\text{s}$; $\delta = 0,01$; typical values.

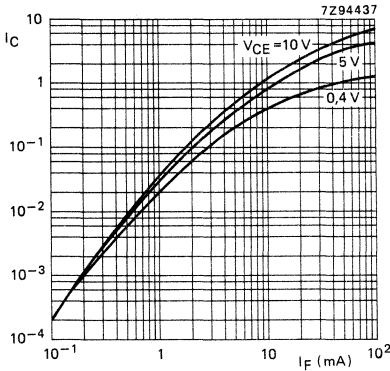

Fig. 5 Normalized to $I_F = 10\text{ mA}$; $V_{CE} = 10\text{ V}$; typical values.

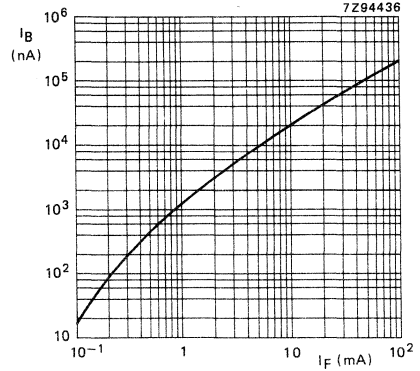

Fig. 6 $V_{CB} = 10\text{ V}$; $T_{amb} = 25\text{ }^\circ\text{C}$; typical values.

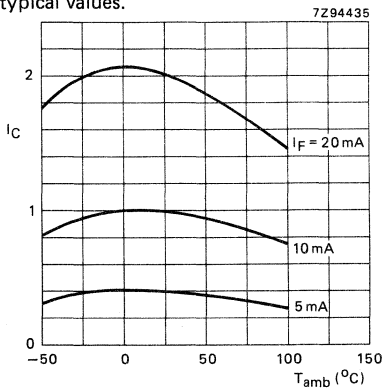

Fig. 7 Normalized at $I_F = 10\text{ mA}$; $V_{CE} = 10\text{ V}$; typical values.

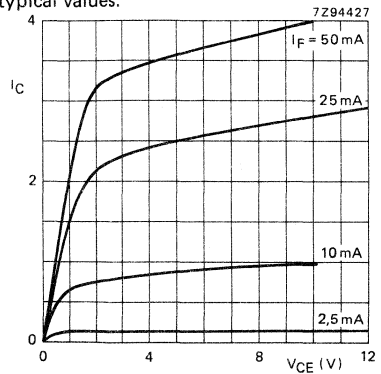

Fig. 8 Normalized at 10 mA ; $V_{CE} = 10\text{ V}$; $T_{amb} = 25\text{ }^\circ\text{C}$. typical values.

OPTOCOUPLER

This product range is one of the industrial standards applied in the market. The current transfer ratio, isolation voltage and low saturation voltage comply to the specifications of the main part of the optocoupler market.

It can be used with TTL circuits and is comprised of an infrared emitting GaAs diode and an N-P-N silicon phototransistor.

UL — Covered under UL component recognition FILE E90700

VDE — Approved according to VDE 0883/6.83

Complied for reinforced isolation at 250 VAC with:

DIN 57 804/VDE 0804/1.83 (isolation group C)

DIN IEC 65/VDE 0860/8.81

QUICK REFERENCE DATA

Collector-emitter voltage of phototransistor	V_{CE0}	max.	30 V
Forward current of infrared emitting diode (d.c.)	I_F	max.	60 mA
D.C. current transfer ratio at $I_F = 10 \text{ mA}$; $V_{CE} = 10 \text{ V}$	I_C/I_F	min.	0,2
Total power dissipation up to $T_{amb} = 25 \text{ }^\circ\text{C}$	P_{tot}	max.	250 mW
Isolation voltage d.c. value	V_{IORM}	min.	4,4 kV

MECHANICAL DATA

SOT-90B (see Fig. 1).

MECHANICAL DATA

Fig. 1 SOT-90B.

Dimensions in mm

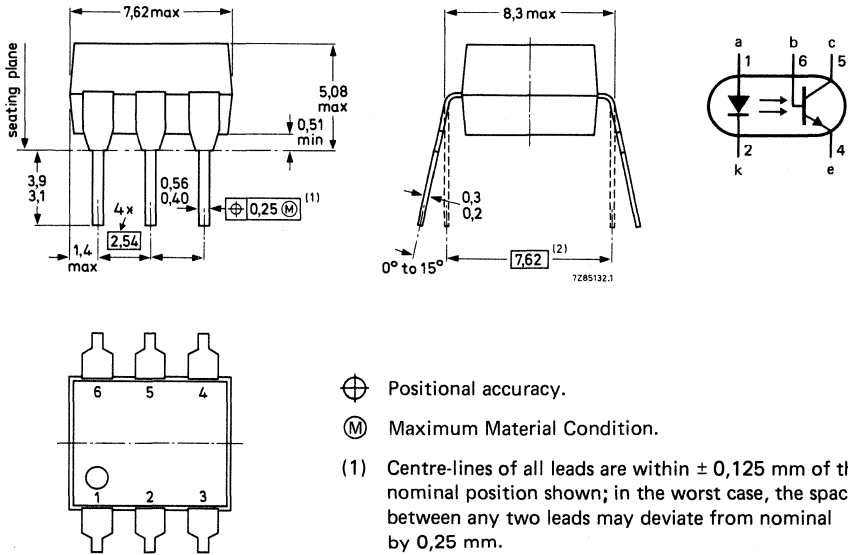

⊕ Positional accuracy.

Ⓜ Maximum Material Condition.

- (1) Centre-lines of all leads are within $\pm 0,125$ mm of the nominal position shown; in the worst case, the spacing between any two leads may deviate from nominal by 0,25 mm.
- (2) When the leads are parallel, the tips remain in position for automatic insertion.

RATINGS

Limiting factors in accordance with the Absolute Maximum System (IEC 134)

Diode

Continuous reverse voltage	V_R	max.	5 V
Forward current			
d.c.	I_F	max.	60 mA
peak value; $t_{on} = 10 \mu s$; $\delta = 0,01$	I_{FRM}	max.	3 A
Total power dissipation			
up to $T_{amb} = 25^\circ C$	P_{tot}	max.	200 mW

Transistor

Collector-emitter voltage (open base)	V_{CEO}	max.	30 V
Collector-base voltage (open emitter)	V_{CBO}	max.	70 V
Emitter-collector voltage (open base)	V_{ECO}	max.	7 V
Collector current (d.c.)	I_C	max.	50 mA
Total power dissipation			
up to $T_{amb} = 25^\circ C$	P_{tot}	max.	200 mW

Optocoupler

Storage temperature	T_{stg}		-55 to +150 °C
Operating junction temperature	T_j		-55 to +125 °C
Soldering temperature up to the seating plane; $t_{sld} < 10$ s	T_{sld}	max.	260 °C
Total power dissipation up to $T_{amb} = 25$ °C	P_{tot}	max.	250 mW

THERMAL RESISTANCE

From junction to ambient in free air			
diode	$R_{th\ j-a}$	max.	500 K/W
transistor	$R_{th\ j-a}$	max.	500 K/W

LINEAR DERATING FACTORS

Above 25 °C			
diode			2,6 mW/K
transistor			2,6 mW/K
optocoupler			3,3 mW/K

ISOLATION RELATED VALUES

External air gap (clearance) input terminals to output terminals	$L(I01)$	min.	7,2 mm
External tracking path (creepage distance) input terminals to output terminals	$L(I02)$	min.	7,0 mm
Tracking resistance (KB-value)			KB-100/A

CHARACTERISTICS

$T_j = 25$ °C unless otherwise specified

Diode

Forward voltage $I_F = 20$ mA	V_F	typ.	1,2 V
		max.	1,5 V
Reverse current $V_R = 5$ V	I_R	max.	10 μ A
Capacitance at $f = 1$ MHz $V = 0$;	C_d	typ.	50 pF

Transistor

Collector-emitter breakdown voltage $I_C = 1$ mA	$V_{(BR)CEO}$	min.	30 V
Collector-base breakdown voltage $I_C = 0,01$ mA	$V_{(BR)CBO}$	min.	70 V
Emitter-collector breakdown voltage $I_E = 0,1$ mA	$V_{(BR)ECO}$	min.	7 V
Dark current $V_{CE} = 10$ V	I_{CEO}	typ.	2 nA
		max.	50 nA
$V_{CB} = 10$ V	I_{CBO}	max.	20 nA
D.C. current gain $I_C = 100$ μ A; $V_{CE} = 5$ V	h_{FE}	typ.	300

Optocoupler

Output/input d.c. current transfer ratio

$$I_F = 10 \text{ mA}; V_{CE} = 10 \text{ V}$$

I_C/I_F	typ.	0,6
	min.	0,2

Collector-emitter saturation voltage

$$I_F = 16 \text{ mA}; I_C = 2 \text{ mA}$$

V_{CEsat}	max.	0,4 V
	typ.	0,15 V

Emitter-base capacitance

$$V_{BE} = 0$$

C_{be}	typ.	8 pF
----------	------	------

Collector-base capacitance at $f = 1 \text{ MHz}$

$$V_{CB} = 10 \text{ V}$$

C_{bc}	typ.	4,5 pF
----------	------	--------

Collector-emitter capacitance

$$V_{CE} = 0$$

C_{ce}	typ.	8 pF
----------	------	------

Isolation voltage*

V_{IORM}	min.	4,4 kV(d.c.) 3,12 kV(r.m.s.)
------------	------	---------------------------------

Capacitance between input and output

$$V = 0; f = 1 \text{ MHz}$$

C_{io}	typ.	0,5 pF
----------	------	--------

Insulation resistance between input and output

$$V_{IO} = \pm 500 \text{ V}$$

R_{IO}	min.	$10^{11} \Omega$
	typ.	$10^{12} \Omega$

Turn-on time (saturated) see Fig. 2 (TTL def.)

$$I_F = 15 \text{ mA}; V_{CC} = 5 \text{ V}; R_L = 2 \text{ k}\Omega$$

$$R_{BE} = \infty$$

t_{on}	typ.	5 μ s
----------	------	-----------

$$I_F = 20 \text{ mA}; V_{CC} = 5 \text{ V}; R_L = 2 \text{ k}\Omega$$

$$R_{BE} = 100 \text{ k}\Omega$$

t_{on}	typ.	5 μ s
----------	------	-----------

Turn-off time (saturated) see Fig. 2 (TTL def.)

$$I_F = 15 \text{ mA}; V_{CC} = 5 \text{ V}; R_L = 2 \text{ k}\Omega$$

$$R_{BE} = \infty$$

t_{off}	typ.	30 μ s
-----------	------	------------

$$I_F = 20 \text{ mA}; V_{CC} = 5 \text{ V}; R_L = 2 \text{ k}\Omega$$

$$R_{BE} = 100 \text{ k}\Omega$$

t_{off}	typ.	10 μ s
-----------	------	------------

Bandwidth

$$I_C = 2 \text{ mA}; V_{CE} = 10 \text{ V}; R_L = 100 \text{ k}\Omega$$

BW	typ.	300 kHz
----	------	---------

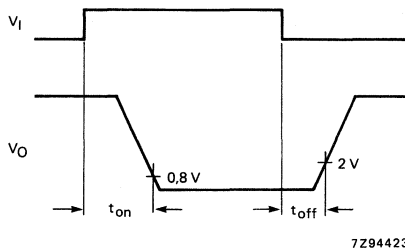
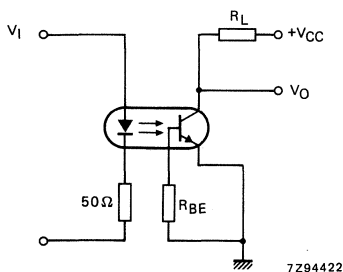

Fig. 2 Measuring circuit and waveforms.

* Every single product is tested by applying an isolation test voltage of 3750 V (r.m.s.) for 2 seconds between the shorted input (diode) leads and the shorted output (phototransistor) leads.

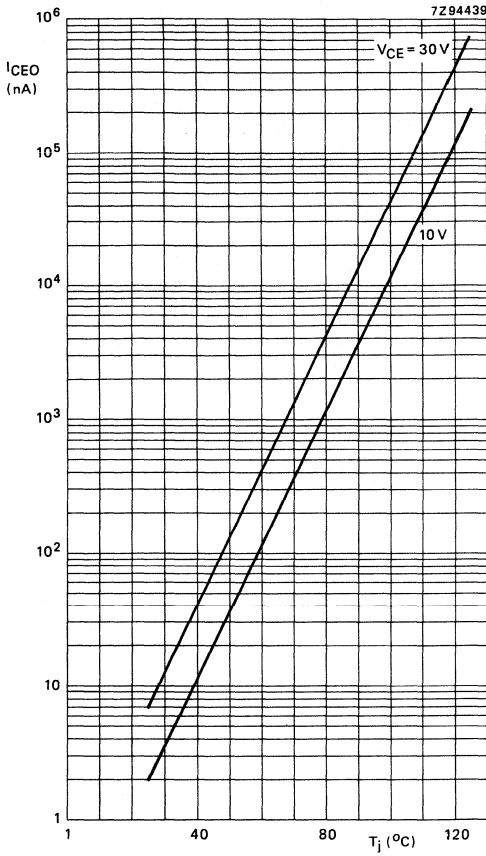

Fig. 3. Typical values.

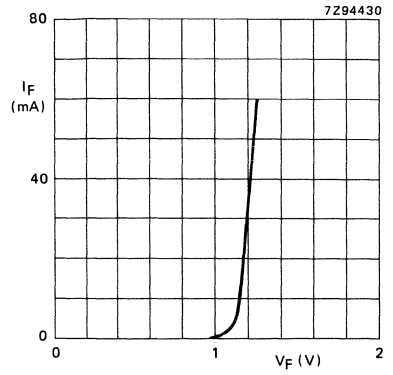

Fig. 4 $T_{amb} = 25^\circ C$; typical values.

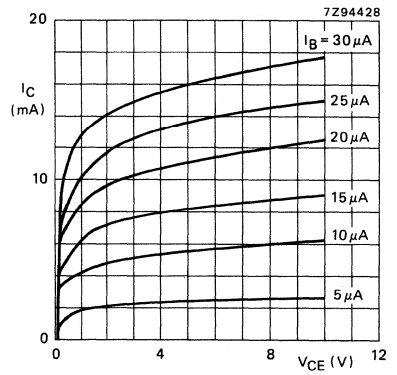

Fig. 5 $T_{amb} = 25^\circ C$; typical values.

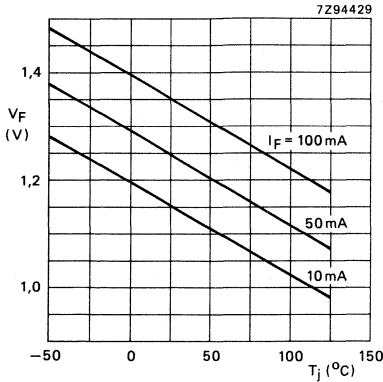

Fig. 6 Typical values.

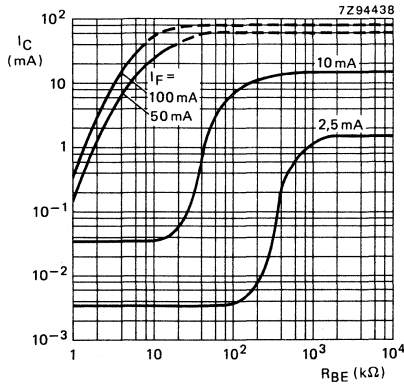

Fig. 8 $V_{CE} = 5 V$; $T_{amb} = 25 \text{ }^\circ\text{C}$; typical values.

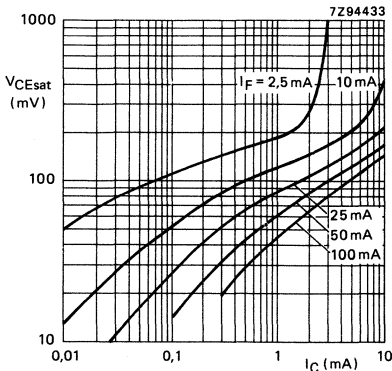

Fig. 10 $T_{amb} = 25 \text{ }^\circ\text{C}$; typical values.

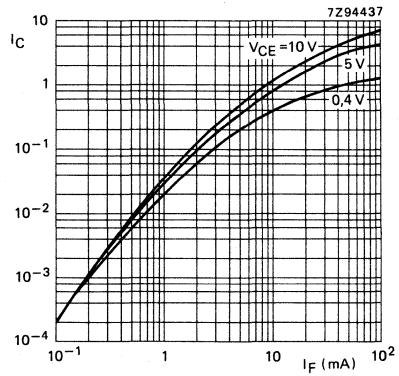

Fig. 7 Normalized to $I_F = 10 \text{ mA}$; $V_{CE} = 10 \text{ V}$; $T_{amb} = 25 \text{ }^\circ\text{C}$; typical values.

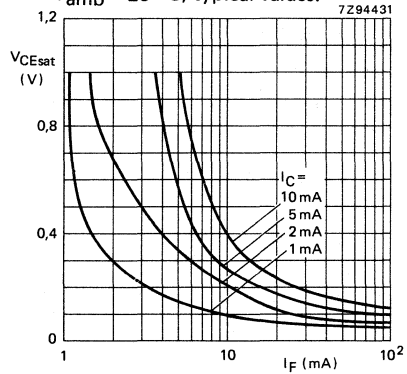

Fig. 9 $T_{amb} = 25 \text{ }^\circ\text{C}$; typical values.

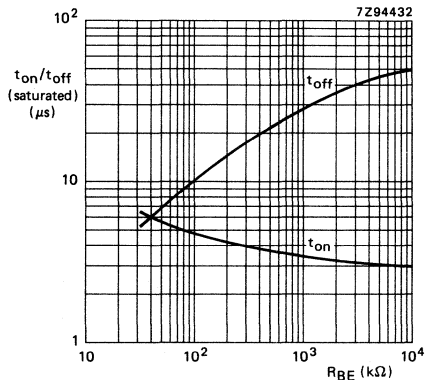

Fig. 11 $I_F = 20 \text{ mA}$; $R_L = 2 \text{ k}\Omega$; $T_{amb} = 25 \text{ }^\circ\text{C}$; typical values.

OPTOCOUPLER

Optocoupler in a DIL plastic envelope. The MCT26 comprises an infrared GaAs diode and a N-P-N silicon phototransistor.

UL — Covered under UL component recognition FILE E90700

VDE — Approved according to VDE 0883/6.83

Complied for reinforced isolation at 250 VAC with:

DIN 57 804/VDE 0804/1.83 (isolation group C)

DIN IEC 65/VDE 0860/8.81

QUICK REFERENCE DATA

Collector-emitter voltage of phototransistor	V_{CEO}	max.	30 V
Forward current of infrared emitting diode (d.c.)	I_F	max.	60 mA
D.C. current transfer ratio at $I_F = 10 \text{ mA}$; $V_{CE} = 10 \text{ V}$	I_C/I_F	min.	0,06
Total power dissipation up to $T_{amb} = 25 \text{ }^\circ\text{C}$	P_{tot}	max.	250 mW
Isolation voltage d.c. value	V_{IORM}	min.	4,4 kV

MECHANICAL DATA

SOT-90B (see Fig. 1).

Optocoupler

Storage temperature	T_{stg}	–55 to +150 °C
Operating junction temperature	T_j	–55 to +125 °C
Soldering temperature up to the seating plane; $t_{sld} < 10$ s	T_{sld}	max. 260 °C
Total power dissipation up to $T_{amb} = 25$ °C	P_{tot}	max. 250 mW

THERMAL RESISTANCE

From junction to ambient in free air diode	$R_{th\ j-a}$	max. 500 K/W
transistor	$R_{th\ j-a}$	max. 500 K/W

LINEAR DERATING FACTORS

Above 25 °C		
diode		2,6 mW/K
transistor		2,6 mW/K
optocoupler		3,3 mW/K

ISOLATION RELATED VALUES

External air gap (clearance) input terminals to output terminals	L(I01)	min. 7,2 mm
External tracking path (creepage distance) input terminals to output terminals	L(I02)	min. 7,0 mm
Tracking resistance (KB-value)		KB-100/A

CHARACTERISTICS

$T_j = 25$ °C unless otherwise specified

Diode

Forward voltage $I_F = 20$ mA	V_F	typ. 1,2 V max. 1,5 V
Reverse current $V_R = 5$ V	I_R	max. 10 μ A
Capacitance at $f = 1$ MHz $V = 0$	C_d	typ. 50 pF

Transistor

Collector-emitter breakdown voltage $I_C = 1$ mA	$V_{(BR)CEO}$	min. 30 V
Collector-base breakdown voltage $I_C = 0,01$ mA	$V_{(BR)CBO}$	min. 30 V
Emitter-collector breakdown voltage $I_E = 0,1$ mA	$V_{(BR)ECO}$	min. 7 V
Dark current $V_{CE} = 5$ V	I_{CEO}	typ. 2 nA max. 100 nA
$V_{CB} = 5$ V	I_{CBO}	max. 100 nA
D.C. current gain $I_C = 100$ μ A; $V_{CE} = 5$ V	h_{FE}	typ. 300

Optocoupler

Output/input d.c. current transfer ratio

$I_F = 10 \text{ mA}; V_{CE} = 10 \text{ V}$

I_C/I_F min. 0,06

Collector-emitter saturation voltage

$I_F = 20 \text{ mA}; I_C = 0,25 \text{ mA}$

V_{CEsat} max. 0,3 V
typ. 0,1 V

$I_F = 60 \text{ mA}; I_C = 1,6 \text{ mA}$

V_{CEsat} max. 0,5 V
typ. 0,2 V

Collector-emitter capacitance

$V_{CE} = 0$

C_{ce} typ. 8 pF

Isolation voltage *

V_{IORM} min. 4,4 kV(d.c.)
3,12 kV(r.m.s.)

Capacitance between input and output

$V = 0; f = 1 \text{ MHz}$

C_{io} typ. 0,5 pF

Insulation resistance between

input and output

$V_{IO} = 500 \text{ V}$

R_{IO} min. $10^{11} \Omega$
typ. $10^{12} \Omega$

Rise time (see Fig. 2)

$I_C = 2 \text{ mA}; V_{CC} = 10 \text{ V}; R_L = 100 \Omega$

t_r typ. 3 μs

Fall time (see Fig. 2)

$I_C = 2 \text{ mA}; V_{CC} = 10 \text{ V}; R_L = 100 \Omega$

t_f typ. 3 μs

Bandwidth

$I_C = 2 \text{ mA}; V_{CE} = 10 \text{ V}; R_L = 100 \Omega$

BW typ. 300 kHz

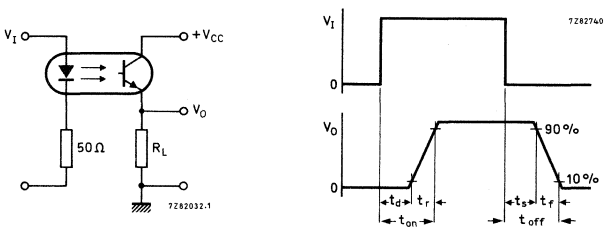

Fig. 2 Measuring circuit and waveforms.

* Every single product is tested by applying an isolation test voltage of 3750 V (r.m.s.) for 2 seconds between the shorted input (diode) leads and the shorted output (phototransistor) leads.

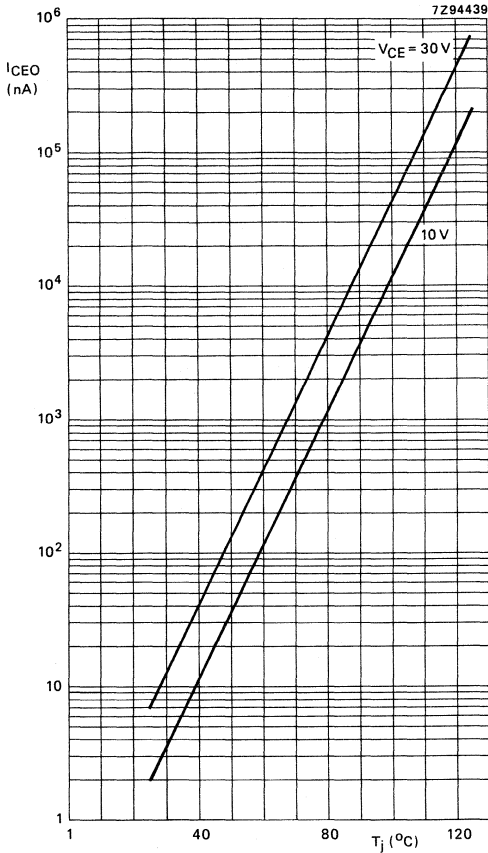

Fig. 3 Typical values.

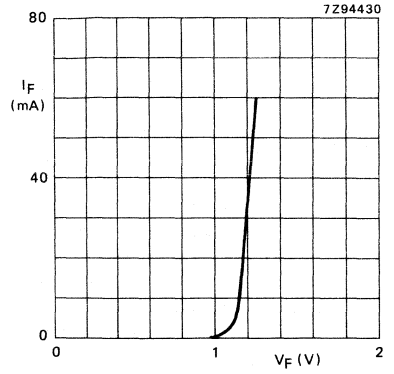

Fig. 4 $T_{amb} = 25\text{ }^\circ\text{C}$; typical values.

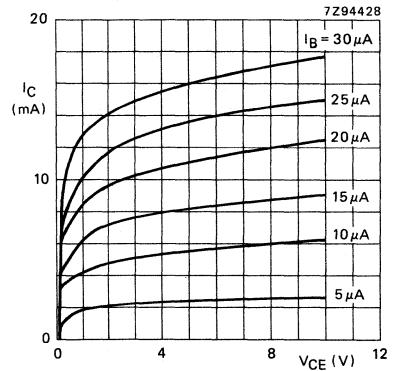

Fig. 5 $T_{amb} = 25\text{ }^\circ\text{C}$; typical values.

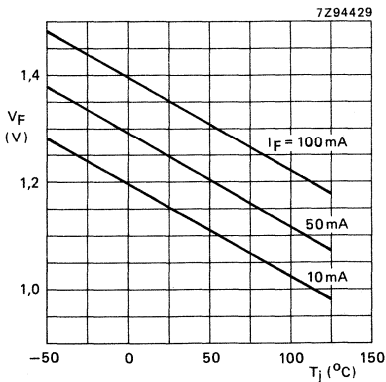

Fig. 6 Typical values.

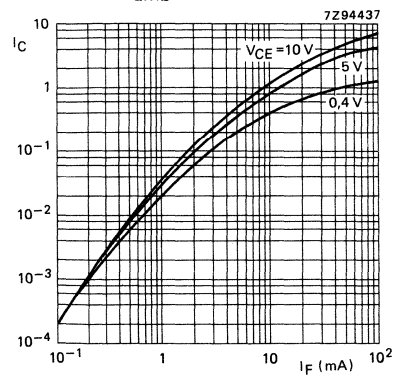

Fig. 7 Normalized to $I_F = 10\text{ mA}$; $V_{CE} = 10\text{ V}$; $T_{amb} = 25\text{ }^\circ\text{C}$; typical values.

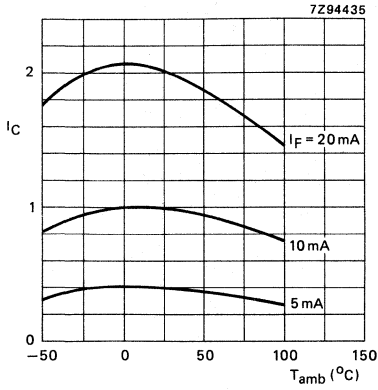

Fig. 8 Normalized to $I_F = 10 \text{ mA}$; $V_{CE} = 10 \text{ V}$; $T_{amb} = 25 \text{ }^{\circ}C$; typical values.

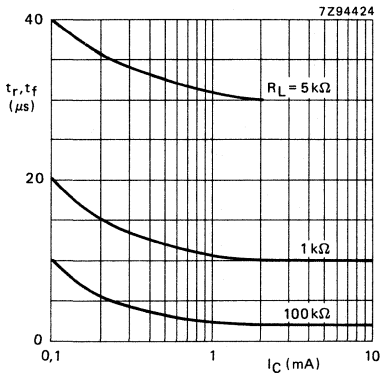

Fig. 9 $T_{amb} = 25 \text{ }^{\circ}C$; typical values.

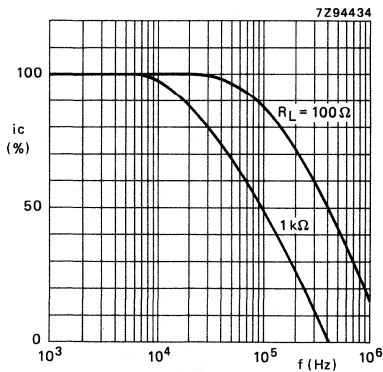

Fig. 10 $I_C = 2 \text{ mA}$; $V_{CC} = 10 \text{ V}$; $T_{amb} = 25 \text{ }^{\circ}C$; typical values.

DEVELOPMENT DATA

This data sheet contains advance information and specifications are subject to change without notice.

PO40/44A

OPTOCOUPLER

Optically coupled isolator consisting of an infrared emitting GaAlAs diode and a silicon n-p-n phototransistor with accessible base in a SOT-90B envelope. Designed for low input current and long life operation.

The application of an IR emitting device, based on a special GaAlAs (intrinsic) process, results in perfect linearity at low input currents and a very low degradation during the device's operating life.

The PO40/44A is selected according to British Telecom specifications for telephony and can serve for each individual spec PO40A, PO41A, PO42A, PO43A, PO44A and is BT approved.

QUICK REFERENCE DATA

Diode

Forward current (d.c.) I_F max. 100 mA

Transistor

Collector-emitter voltage (open base) V_{CEO} max. 30 V

Optocoupler

Output/input d.c. current transfer ratio (C.T.R.)

$I_F = 0,5 \text{ mA}; V_{CE} = 5 \text{ V}$ I_C/I_F min. 0,1

$I_F = 1,0 \text{ mA}; V_{CE} = 0,4 \text{ V}$ I_C/I_F min. 0,25

$I_F = 10 \text{ mA}; V_{CE} = 0,5 \text{ V}$ I_C/I_F min. 0,6

Leakage current under working voltage 1,5 kV d.c. value

$V_{CC} = 10 \text{ V}$ I_{CEW} max. 200 nA

Isolation voltage d.c. value

V_{IORM} min. 3,5 kV

MECHANICAL DATA

SOT-90B (see Fig. 1).

MECHANICAL DATA

Fig. 1 SOT-90B.

Dimensions in mm

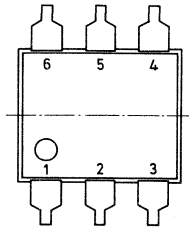
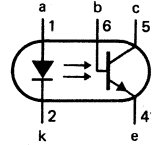
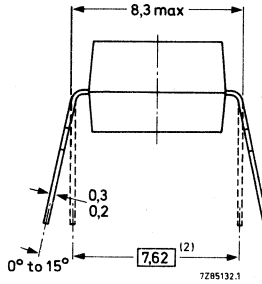
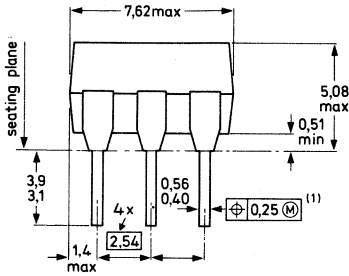

⊕ Positional accuracy.

Ⓜ Maximum Material Condition.

- (1) Centre-lines of all leads are within $\pm 0,125$ mm of the nominal position shown; in the worst case, the spacing between any two leads may deviate from nominal by 0,25 mm.
- (2) When the leads are parallel, the tips are in position for automatic insertion.

RATINGS

Limiting values in accordance with the Absolute Maximum System (IEC 134)

Diode

Continuous reverse voltage	V_R	max.	5 V
Forward current			
d.c.	I_F	max.	100 mA
(peak value); $t_p = 10 \mu s$; $\delta = 0,01$	I_{FRM}	max.	2,5 A
Total power dissipation up to $T_{amb} = 25 \text{ }^\circ\text{C}$	P_{tot}	max.	200 mW

Transistor

Collector-emitter voltage (open base)	V_{CEO}	max.	30 V
Collector-base voltage (open emitter)	V_{CBO}	max.	70 V
Emitter-collector voltage (open base)	V_{ECO}	max.	5 V
Collector current	I_C	max.	100 mA
Total power dissipation up to $T_{amb} = 25 \text{ }^\circ\text{C}$	P_{tot}	max.	200 mW

Optocoupler

Storage temperature	T_{stg}	-55 to +150 °C
Operating ambient temperature	T_{amb}	-55 to +100 °C
Total power dissipation up to $T_{amb} = 25$ °C	P_{tot}	max. 250 mW
Lead soldering temperature up to the seating plane; $t_{slid} < 10$ s	T_{slid}	max. 260 °C

THERMAL RESISTANCE

From junction to ambient in free air diode	$R_{th j-a}$	max. 500 K/W
transistor	$R_{th j-a}$	max. 500 K/W
From junction to ambient, device mounted on a printed circuit board diode	$R_{th j-a}$	max. 400 K/W
transistor	$R_{th j-a}$	max. 400 K/W

ISOLATION RELATED VALUES

External air gap (clearance) input terminals to output terminals	$L(I01)$	min. 7,2 mm
External tracking path (creepage distance) input terminals to output terminals	$L(I02)$	min. 7,0 mm
Tracking resistance (KB-value)		KB-100/A

CHARACTERISTICS

$T_j = 25$ °C unless otherwise specified

Diode

Forward voltage $I_F = 10$ mA	V_F	typ. 1,45 V max. 1,6 V *
$I_F = 0,1$ mA; $T_{amb} = 70$ °C	V_F	min. 0,45 V
Reverse current $V_R = 5$ V	I_R	max. 10 μ A

Transistor

Collector-emitter breakdown voltage open base; $I_C = 1$ mA	$V(BR)_{CEO}$	min. 30 V
Collector-base breakdown voltage open emitter; $I_C = 0,1$ mA	$V(BR)_{CBO}$	min. 70 V
Emitter-collector breakdown voltage open base; $I_E = 0,1$ mA	$V(BR)_{ECO}$	min. 5 V
Collector cut-off current (dark) $V_{CE} = 28$ V	I_{CEO}	typ. 2 nA max. 200 nA

* Internal specification.

Optocoupler

Output/input d.c. current transfer ratio (C.T.R.)

$I_F = 10 \text{ mA}; V_{CE} = 0,5 \text{ V}$

I_C/I_F min. 0,6
max. 1,5

$I_F = 1 \text{ mA}; V_{CE} = 0,4 \text{ V}$

I_C/I_F min. 0,25

$I_F = 0,5 \text{ mA}; V_{CE} = 5 \text{ V}$

I_C/I_F min. 0,1

$I_F = 3 \text{ mA}; V_{CE} = 1 \text{ V}$

I_C/I_F min. 0,3

$I_F = 5 \text{ mA}; V_{CE} = 5 \text{ V}$

I_C/I_F min. 0,3

$I_F = 10 \text{ mA}; V_{CE} = 10 \text{ V}$

I_C/I_F min. 0,25

$I_F = 20 \text{ mA}; V_{CE} = 0,5 \text{ V}$

I_C/I_F min. 0,25

Collector current

$I_F = 0,1 \text{ mA}; V_{CE} = 5 \text{ V}$

I_{CE} max. 100 μA

DC current gain

$I_C = 0,4 \text{ mA}; V_{CE} = 1 \text{ V}$

h_{FE} min. 200

Collector-emitter saturation voltage

$I_F = 10 \text{ mA}; I_C = 1 \text{ mA}$

V_{CEsat} max. 0,5 V

Output capacitance

$V_{CB} = 10 \text{ V}; f = 1 \text{ MHz}$

C_{bc} typ. 4,5 pF

Collector cut-off current (dark) at

working voltage $V_W = 1,5 \text{ kV};$

(d.c. value) see notes 1 and 2

$V_{CC} = 10 \text{ V};$

$V_{CC} = 10 \text{ V}; T_j = 70 \text{ }^\circ\text{C}$

I_{CEW} max. 200 nA

I_{CEW} max. 100 μA

Isolation voltage (d.c. value)

see note 3

V_{IORM} min. 3,5 kV

Capacitance between input and output

$V = 0; f = 1 \text{ MHz}$

C_{io} typ. 0,6 pF

Insulation resistance between input and output

$\pm V_{IO} = 1 \text{ kV}$

R_{IO} min. $10^{10} \Omega$
typ. $10^{12} \Omega$

Switching times (see figures 3 and 4)

$I_C = 2 \text{ mA}; V_{CC} = 5 \text{ V}; R_L = 100 \Omega$

Turn-on time

t_{on} max. 7 μs

Turn-off time

t_{off} max. 7 μs

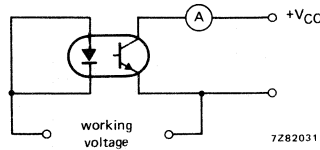

Fig. 2.

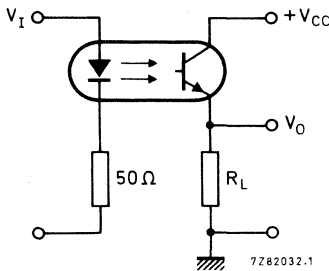

Fig. 3 Switching circuit.

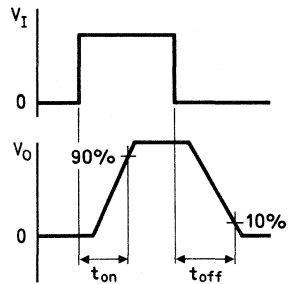

Fig. 4 Waveforms.

DEVELOPMENT DATA

Notes.

1. This parameter is the maximum collector-emitter leakage current measured when a high voltage is applied between the emitter and the two shorted diode leads (see Fig. 2).
2. As quality assurance (on a sample basis), these parameters are covered by a 1000 hour reliability test.
3. Tested on sample basis. The input diode leads are shorted together and all the transistor leads shorted together, then a test voltage of 4,4 kV (d.c.) is applied for 1 min.

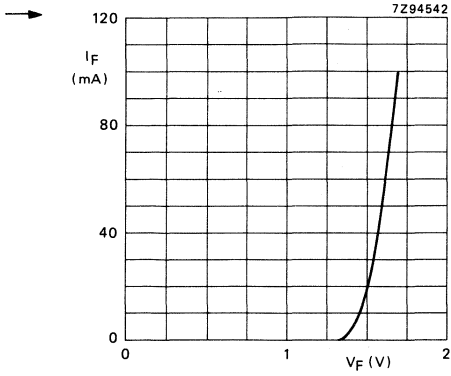

Fig. 5 $T_{amb} = 25\text{ }^\circ\text{C}$; typical values.

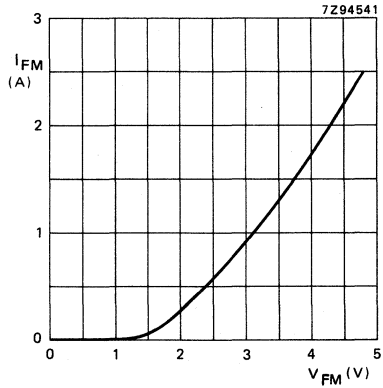

Fig. 6 $T_{amb} = 25\text{ }^\circ\text{C}$; $t_p = 10\text{ }\mu\text{s}$; $T = 1\text{ ms}$; typical values.

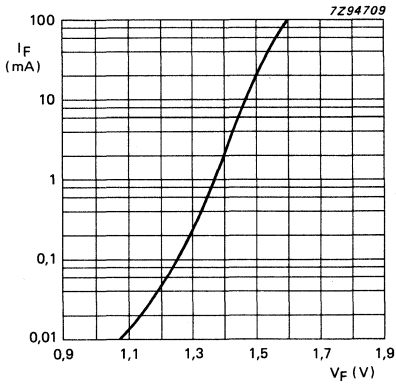

Fig. 7 $T_{amb} = 25\text{ }^\circ\text{C}$; typical values.

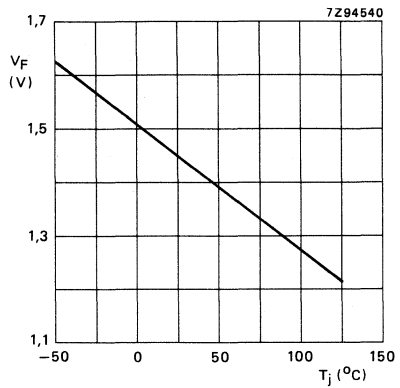

Fig. 8 $I_F = 10\text{ mA}$; typical values.

DEVELOPMENT DATA

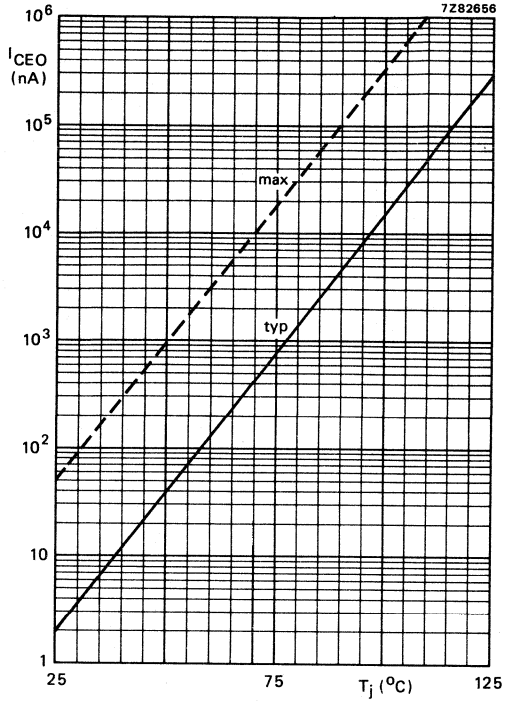

Fig. 9 $I_F = 0$; $V_{CE} = 10$ V; typical values.

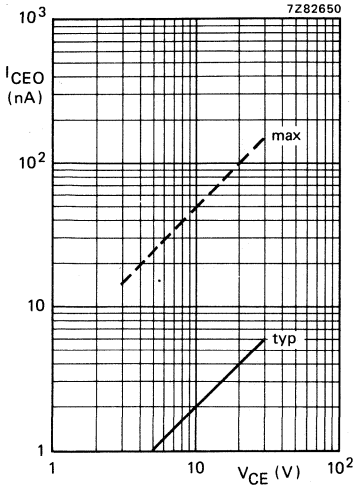

Fig. 10 $I_F = 0$; $T_j = 25^\circ\text{C}$.

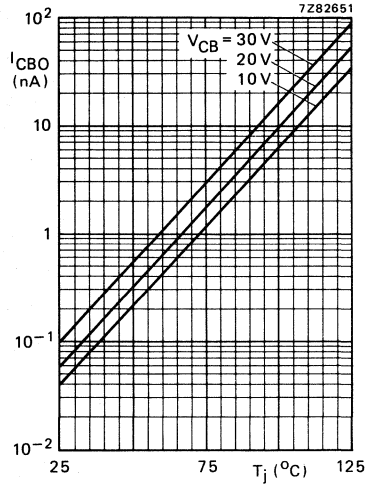

Fig. 11 Typical values.

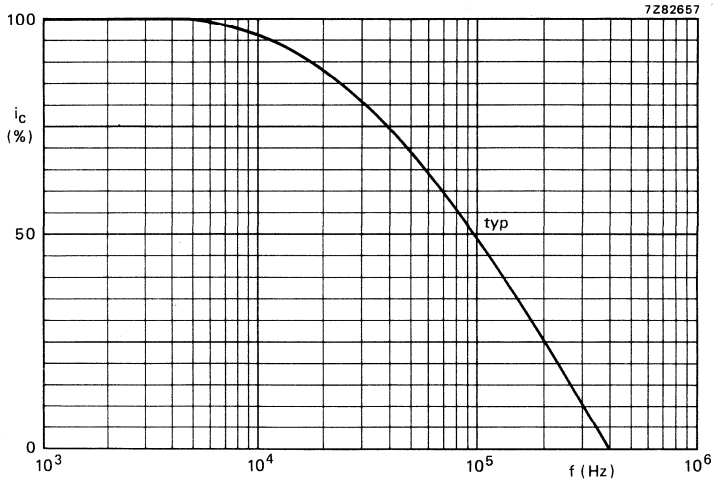

Fig. 12 $I_B = 0$; $I_C = 2\text{ mA}$; $V_{CC} = 5\text{ V}$; $R_L = 1\text{ k}\Omega$; $T_{amb} = 25^\circ\text{C}$.

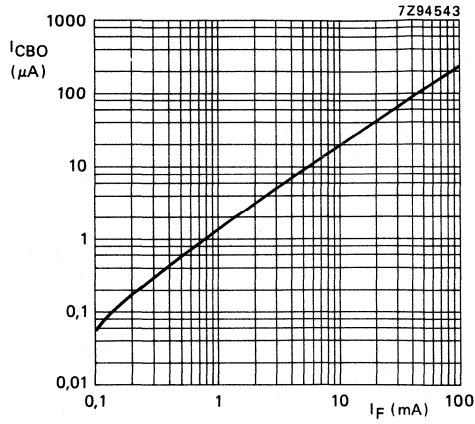

Fig. 13 $V_{CB} = 5 V$; $T_{amb} = 25 ^\circ C$;
typical values.

DEVELOPMENT DATA

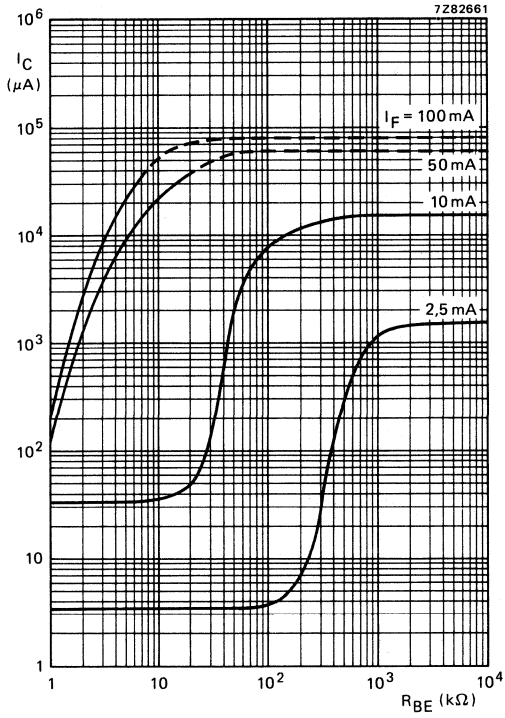

Fig. 14 $I_B = 0$; $V_{CE} = 5\text{ V}$; $T_{amb} = 25\text{ }^\circ\text{C}$; typical values.

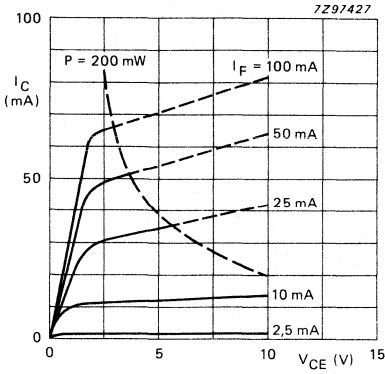

Fig. 15 $T_{amb} = 25 \text{ }^\circ\text{C}$; typical values.

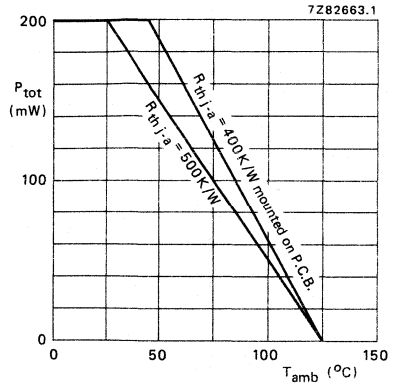

Fig. 16

DEVELOPMENT DATA

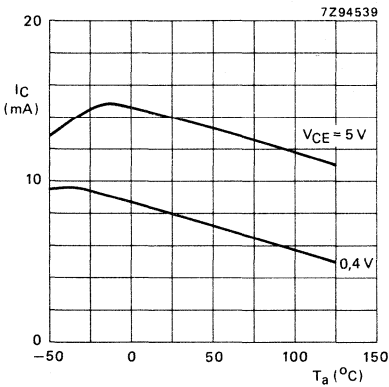

Fig. 17 $I_F = 10 \text{ mA}$; typical values.

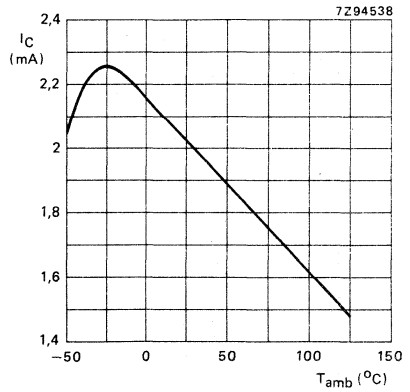

Fig. 18 $I_F = 2 \text{ mA}$; $V_{CE} = 0,4 \text{ V}$; typical values.

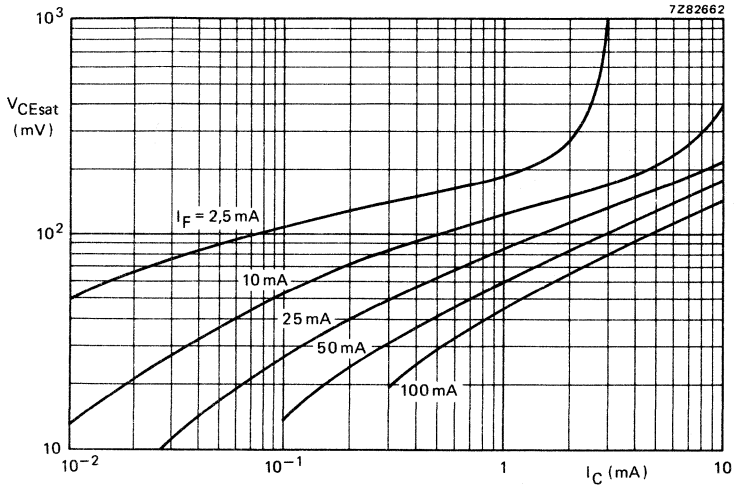

Fig. 19. $I_B = 0$; $T_{amb} = 25^\circ C$; typical values.

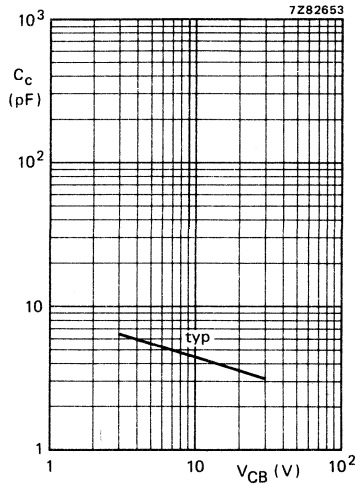

Fig. 20. $f = 1$ MHz; $T_{amb} = 25^\circ C$.

DEVELOPMENT DATA

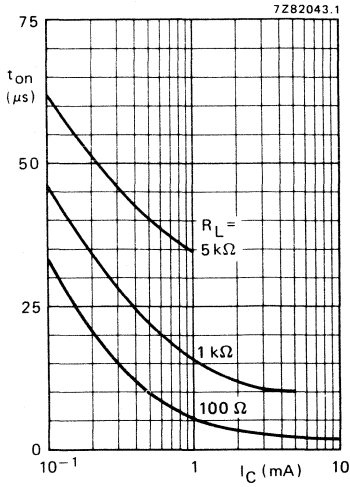

Fig. 21. $I_B = 0$; $V_{CC} = 5$ V; $T_{amb} = 25$ °C; typical values. (See also Fig. 23).

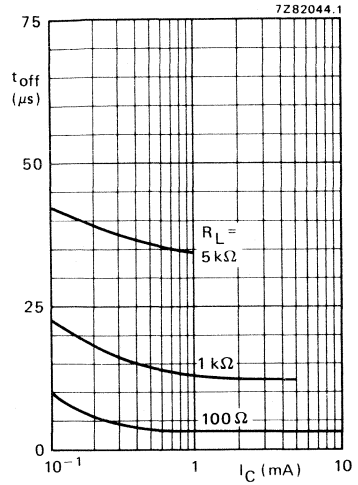
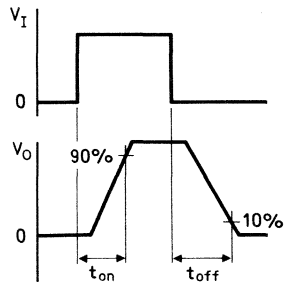
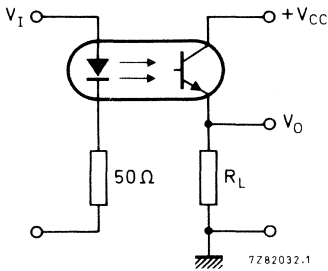

Fig. 22. $I_B = 0$; $V_{CC} = 5$ V; $T_{amb} = 25$ °C; typical values. (See also Fig. 23).



7267238.2

Fig. 23. Switching circuit and waveforms.

OPTOCOUPERS

This product range is one of the industrial standards applied in the market. The current transfer ratio, isolation voltage and low saturation voltage comply to the specifications of the main part of the optocoupler market.

This range can be used with TTL circuits and is comprised of an infrared emitting GaAs diode and an N-P-N silicon phototransistor.

UL — Covered under UL component recognition FILE E90700

VDE — Approved according to VDE 0883/6.83

QUICK REFERENCE DATA

Collector-emitter voltage of phototransistor*		V_{CEO}	max.	30 V
Forward current of infrared emitting diode (d.c.)*		I_F	max.	80 mA
D.C. current transfer ratio at $I_F = 10 \text{ mA}; V_{CE} = 10 \text{ V}^*$	4N25 to 4N26	I_C/I_F	min.	0,2
	4N27 4N28	I_C/I_F	min.	0,1
Total power dissipation up to $T_{amb} = 25 \text{ }^\circ\text{C}$		P_{tot}	max.	250 mW
Isolation voltage (see note 1)		V_{IORM}	min.	2,0 kV(r.m.s.)

MECHANICAL DATA

SOT-90B (see Fig. 1).

* Indicates JEDEC registered data.

MECHANICAL DATA

Fig. 1 SOT-90B.

Dimensions in mm

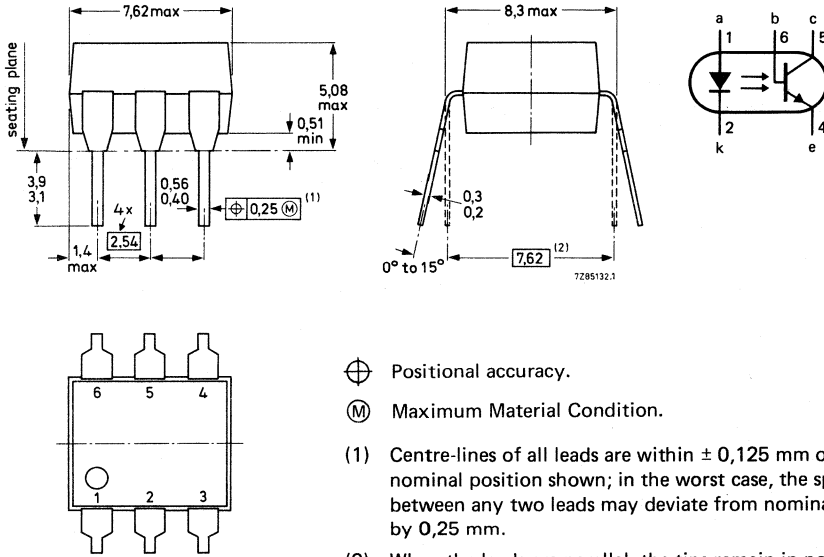

- ⊕ Positional accuracy.
- Ⓜ Maximum Material Condition.

- (1) Centre-lines of all leads are within $\pm 0,125$ mm of the nominal position shown; in the worst case, the spacing between any two leads may deviate from nominal by 0,25 mm.
- (2) When the leads are parallel, the tips remain in position for automatic insertion.

RATINGS

Limiting factors in accordance with the Absolute Maximum System (IEC 134)

Diode

Continuous reverse voltage*	V_R	max.	5 V
Forward current*	I_F	max.	80 mA
d.c.	I_{FRM}	max.	3 A
peak value; $t_{ON} = 300 \mu s$; $\delta = 0,02$			
Total power dissipation up to $T_{amb} = 25 \text{ }^\circ\text{C}$ *	P_{tot}	max.	150 mW

Transistor

Collector-emitter voltage (open base)*	V_{CEO}	max.	30 V
Collector-base voltage (open emitter)*	V_{CBO}	max.	70 V
Emitter-collector voltage (open base)*	V_{ECO}	max.	7 V
Collector current (d.c.)	I_C	max.	100 mA
Total power dissipation up to $T_{amb} = 25 \text{ }^\circ\text{C}$ *	P_{tot}	max.	150 mW

* Indicates JEDEC registered data.

Optocoupler

Storage temperature*	T_{stg}	-55 to +150 °C	
Operating junction temperature*	T_j	-55 to +100 °C	
Soldering temperature up to the seating plane; $t_{sld} < 10$ s	T_{sld}	max. 260 °C	
Total power dissipation up to $T_{amb} = 25$ °C	P_{tot}	max. 250 mW	←

THERMAL RESISTANCE

From junction to ambient in free air diode	$R_{th\ j-a}$	max. 500 K/W
transistor	$R_{th\ j-a}$	max. 500 K/W

LINEAR DERATING FACTORS

Above 25 °C		
diode*		2 mW/K
transistor *		2 mW/K
optocoupler*		3,3 mW/K

ISOLATION RELATED VALUES

External air gap (clearance) input terminals to output terminals	L(I01)	min. 7,2 mm
External tracking path (creepage distance) input terminals to output terminals	L(I02)	min. 7,0 mm
Tracking resistance (KB-value)		KB-100/A

CHARACTERISTICS

$T_j = 25$ °C unless otherwise specified

Diode

Forward voltage* $I_F = 10$ mA	V_F	typ. 1,15 V max. 1,5 V
Reverse current* $V_R = 5$ V	I_R	max. 100 μ A
Capacitance at $f = 1$ MHz $V = 0$	C_d	typ. 50 pF

Transistor

Collector-emitter breakdown voltage* $I_C = 1$ mA	$V_{(BR)CEO}$	min. 30 V
Collector-base breakdown voltage* $I_C = 0,1$ mA	$V_{(BR)CBO}$	min. 70 V
Emitter-collector breakdown voltage* $I_E = 0,1$ mA	$V_{(BR)ECO}$	min. 7 V

* Indicates JEDEC registered data.

4N25 4N25A
4N26 4N27
4N28

Dark current *					
$V_{CE} = 10 \text{ V}$	4N25 to 4N27	I_{CEO}	typ.	2 nA	
			max.	50 nA	
$V_{CB} = 10 \text{ V}$	4N28	I_{CEO}	max.	100 nA	
		I_{CBO}	max.	20 nA	
Optocoupler					
Output/input d.c. current transfer ratio*					
$I_F = 10 \text{ mA}; V_{CE} = 10 \text{ V}$	4N25 to 4N26	I_C/I_F	min.	0,2	
	4N27 4N28	I_C/I_F	min.	0,1	
Collector-emitter saturation voltage*					
$I_F = 50 \text{ mA}; I_C = 2 \text{ mA}$		V_{CEsat}	max.	0,5 V	
			typ.	0,1 V	
Isolation voltage (see notes 1 and 2)		V_{IORM}	min.	2,0 kV(r.m.s.) 2,8 kV(d.c.)	
Capacitance between input and output $V_{IO} = 0; f = 1 \text{ MHz}$		C_{io}	typ.	0,6 pF	
Insulation resistance between input and output $V_{IO} = 500 \text{ V}$		R_{IO}	typ.	$10^{12} \Omega$	
Bandwidth $-I_C = 2 \text{ mA}; V_{CE} = 10 \text{ V}$ $R_L = 100 \Omega$		BW	typ.	300 kHz	
Switching times (unsaturated) see Fig. 2					
Rise time $I_C = 2 \text{ mA}; V_{CC} = 10 \text{ V}; R_L = 100 \Omega$		t_r	typ.	3 μs	
Fall time $I_C = 2 \text{ mA}; V_{CC} = 10 \text{ V}; R_L = 100 \Omega$		t_f	typ.	3 μs	
Switching times (saturated) see Fig. 3					
Turn-on time (TTL def.)					
$I_F = 15 \text{ mA}; V_{CC} = 5 \text{ V}; R_L = 2 \text{ k}\Omega$ $R_{BE} = \infty$		t_{on}	typ.	5 μs	
$I_F = 20 \text{ mA}; V_{CC} = 5 \text{ V}; R_L = 2 \text{ k}\Omega$ $R_{BE} = 100 \text{ k}\Omega$		t_{on}	typ.	5 μs	
Turn-off time (TTL def.)					
$I_F = 15 \text{ mA}; V_{CC} = 5 \text{ V}; R_L = 2 \text{ k}\Omega$ $R_{BE} = \infty$		t_{off}	typ.	30 μs	
$I_F = 20 \text{ mA}; V_{CC} = 5 \text{ V}; R_L = 2 \text{ k}\Omega$ $R_{BE} = 100 \text{ k}\Omega$		t_{off}	typ.	10 μs	

* Indicates JEDEC registered data.

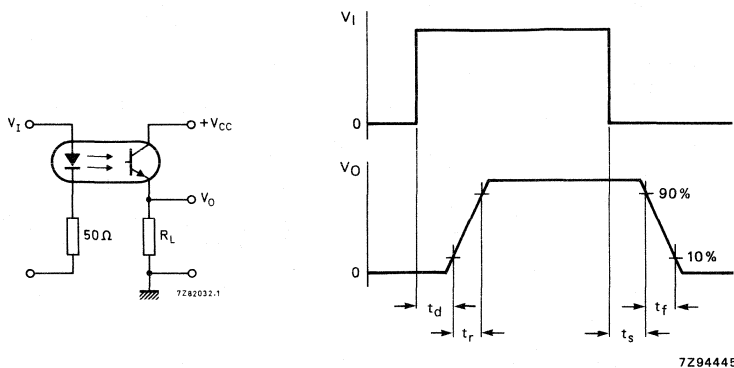

Fig. 2 Measuring circuit and waveforms.

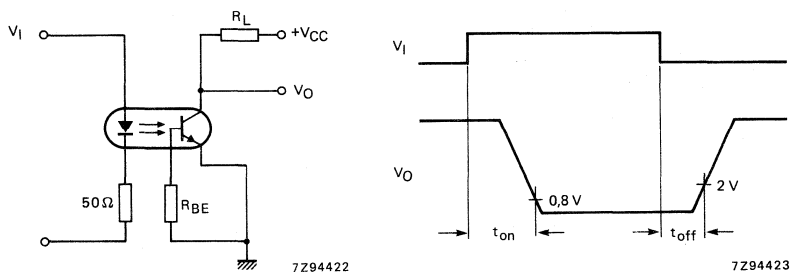

Fig. 3 Measuring circuit and waveforms.

Note 1:

Satisfies JEDEC registered isolation voltage ratings (min. V_{IO}):

4N25	2,5 kV (peak)
4N25-A	1,775 kV (r.m.s.)
4N26	1,5 kV (peak)
4N27	1,5 kV (peak)
4N28	0,5 kV (peak)

Note 2:

Every single product is tested by applying an isolation test voltage of 2500 V (r.m.s.) for 2 seconds between the shorted input (diode) leads and the shorted output (phototransistor) leads.

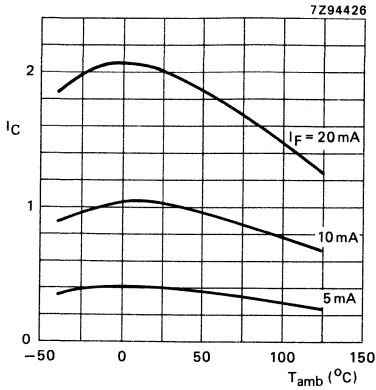

Fig. 4 Normalized at $I_F = 10$ mA; $V_{CE} = 10$ V; $T_{amb} = 25$ °C; typical values.

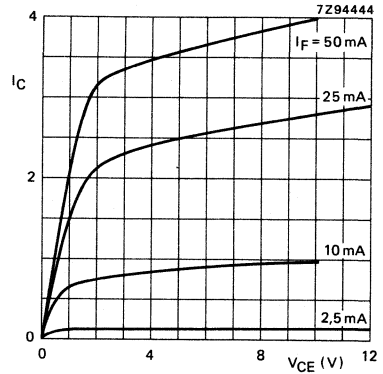

Fig. 5 Normalized at $I_C = 1$ mA; $I_F = 10$ mA; $V_{CE} = 10$ V; typical values.

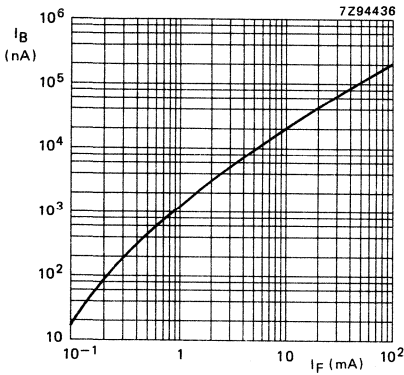

Fig. 6 $V_{CB} = 10$ V; $T_{amb} = 25$ °C; typical values.

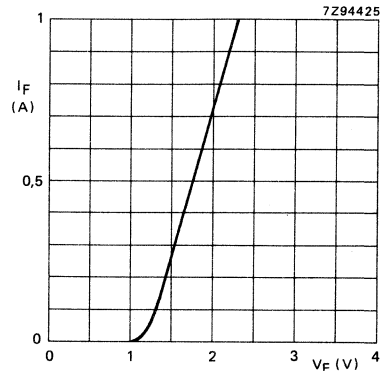

Fig. 7 $T_{amb} = 25$ °C; $t_{on} = 20$ μ s; $\delta = 0,01$; typical values.

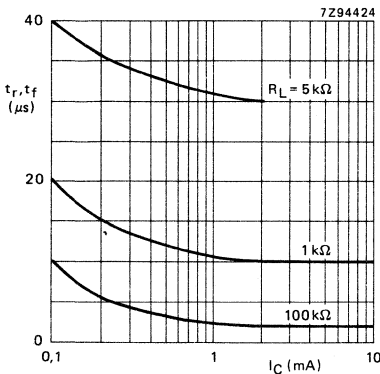

Fig. 8 Normalized at $I_F = 10$ mA; $V_{CE} = 10$ V; $T_{amb} = 25$ °C; typical values.

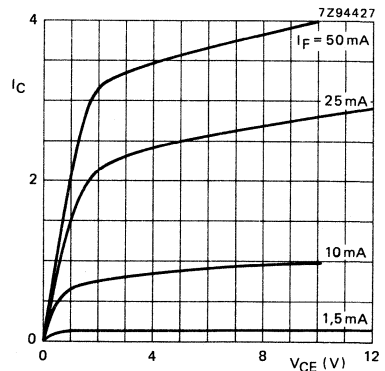

Fig. 9 $T_{amb} = 25$ °C; typical values.

SECTION B1

Special optocouplers (opto high-tech line)

OPTOCOUPLERS

Optocouplers in a hermetically sealed metal envelope. They have high reliability and can be used under severe conditions such as in military or industrial applications. The CNX44 and CNX46 differ only in the pinning connections and both types have an unconnected base.

An outstanding characteristic is the high common-mode rejection ratio.

QUICK REFERENCE DATA

Diode

Continuous reverse voltage	V_R	max.	5 V
Forward current	I_F	max.	100 mA
d.c.	I_{FRM}	max.	3 A
peak value; $t_{ON} = 10 \mu s$; $\delta = 0,01$			
Total power dissipation up to $T_{amb} = 75 \text{ }^\circ\text{C}$ mounted on a p.c.b.	P_{tot}	max.	150 mW

Transistor

Collector-emitter voltage (open base)	V_{CEO}	max.	50 V
Total power dissipation up to $T_{amb} = 75 \text{ }^\circ\text{C}$ mounted on a p.c.b.	P_{tot}	max.	150 mW

Optocoupler

Output/input d.c. current transfer ratio $I_F = 10 \text{ mA}$; $V_{CE} = 0,4 \text{ V}$	I_C/I_F	min.	0,3
Collector cut-off current (dark) $V_{CE} = 15 \text{ V}$; working voltage (d.c.) = 1,0 kV	I_{CEW}	max.	200 nA
Isolation voltage (d.c.)	V_{IORM}	min.	1,0 kV
Common-mode rejection ratio $I_C = 2 \text{ mA}$; $f = 10 \text{ kHz}$	CMRR	typ.	85 dB

MECHANICAL DATA

SOT-104C (see Fig. 1).

MECHANICAL DATA

Fig. 1 SOT-104C.

Dimensions in mm

Lead reference

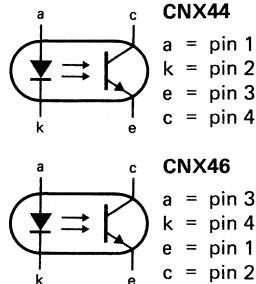
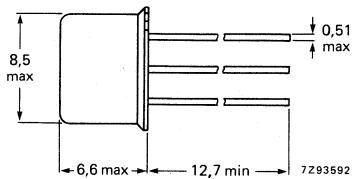
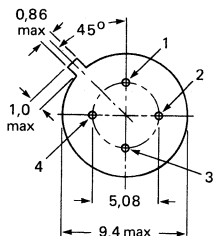

RATINGS

Limiting values in accordance with the Absolute Maximum System (IEC 134)

Diode

Continuous reverse voltage	V_R	max.	5 V
Forward current			
d.c.	I_F	max.	100 mA
peak value; $t_{ON} = 10 \mu s$; $\delta = 0,01$	I_{FRM}	max.	3 A
Total power dissipation up to $T_{amb} = 75 \text{ }^\circ\text{C}$	P_{tot}	max.	150 mW

Transistor

Collector-emitter voltage (open base)	V_{CEO}	max.	50 V
Emitter-collector voltage	V_{ECO}	max.	7 V
Collector current (d.c.)	I_C	max.	100 mA
Total power dissipation up to $T_{amb} = 75 \text{ }^\circ\text{C}$	P_{tot}	max.	150 mW

Optocoupler

Storage temperature	T_{stg}		-65 to +150 $^\circ\text{C}$
Operating ambient temperature	T_{amb}		-55 to +125 $^\circ\text{C}$
Total power dissipation of diode and transistor up to $T_{amb} = 75 \text{ }^\circ\text{C}$	P_{tot}	max.	300 mW

THERMAL RESISTANCE

From junction to ambient			
diode	$R_{th j-a}$	max.	330 K/W
transistor	$R_{th j-a}$	max.	330 K/W

CHARACTERISTICS $T_j = 25\text{ }^\circ\text{C}$ unless otherwise specified**Diode**

Forward voltage

 $I_F = 10\text{ mA}$

V_F	typ.	1,15 V
	max.	1,30 V

 $I_F = 2\text{ mA}; T_{\text{amb}} = 0\text{ to }70\text{ }^\circ\text{C}$

V_F	max.	1,20 V
-------	------	--------

Reverse current

 $V_R = 5\text{ V}$

I_R	typ.	1 μA
	max.	100 μA

Transistor

Collector-emitter breakdown voltage

 $I_C = 1\text{ mA}$

$V_{(\text{BR})\text{CEO}}$	min.	50 V
-----------------------------	------	------

Emitter-collector breakdown voltage

 $I_E = 0,1\text{ mA}$

$V_{(\text{BR})\text{ECO}}$	min.	7 V
-----------------------------	------	-----

Collector cut-off current (dark); diode $I_F = 0$ $V_{\text{CE}} = 20\text{ V}$

I_{CEO}	typ.	5 nA
	max.	100 nA

 $V_{\text{CE}} = 20\text{ V}; T_{\text{amb}} = 70\text{ }^\circ\text{C}$

I_{CEO}	max.	10 μA
------------------	------	------------------

D.C. current gain

 $I_C = 10\text{ mA}; V_{\text{CE}} = 5\text{ V}$

hFE	typ.	600
-----	------	-----

Optocoupler

Output/input d.c. current transfer ratio (C.T.R.)

 $I_F = 10\text{ mA}; V_{\text{CE}} = 0,4\text{ V}$

I_C/I_F	min.	0,3
	typ.	0,6

 $I_F = 10\text{ mA}; V_{\text{CE}} = 5\text{ V}$

I_C/I_F	typ.	1,0
-----------	------	-----

Switching times (see Figs 4 and 5)

 $I_C = 2\text{ mA}; V_{\text{CC}} = 5\text{ V}; R_L = 100\text{ }\Omega$

t_{on}	typ.	5 μs
t_{off}	typ.	5 μs

Collector cut-off current (dark) at
working voltage 1 kV (d.c. value); $V_{\text{CC}} = 15\text{ V}; T_j = 25\text{ }^\circ\text{C}$ (see Fig. 3) $V_{\text{CC}} = 15\text{ V}; T_j = 70\text{ }^\circ\text{C}$ (see Fig. 3)

I_{CEW}	max.	200 nA*
	max.	50 μA *

Isolation voltage (d.c. value) between
shorted input and shorted output terminals

V_{IORM}	min.	1,0 kV
-------------------	------	--------

Capacitance between input and output

 $V = 0; f = 1\text{ MHz}$

C_{IO}	typ.	1 pF
-----------------	------	------

Insulation resistance between input and output

 $V_{\text{IO}} = 500\text{ V}$

R_{IO}	min.	$10^{11}\text{ }\Omega$
	typ.	$10^{12}\text{ }\Omega$

Common-mode rejection ratio (see Fig. 2)

 $I_C = 2\text{ mA}; f = 10\text{ kHz}$

CMRR	typ.	85 dB
------	------	-------

* As quality assurance (on a sample basis), these parameters are covered by a 1000 h reliability test.

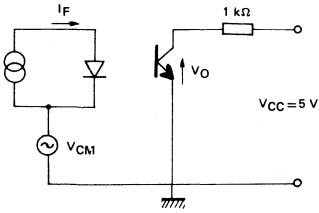

Fig. 2.

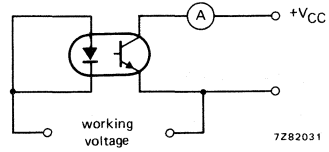

Fig. 3.

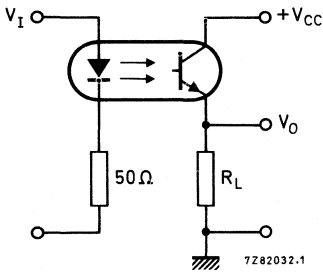

Fig. 4.

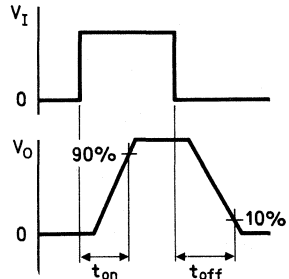

Fig. 5.

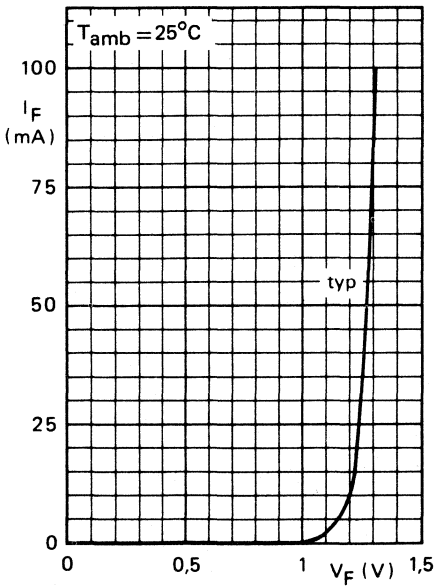

Fig. 6.

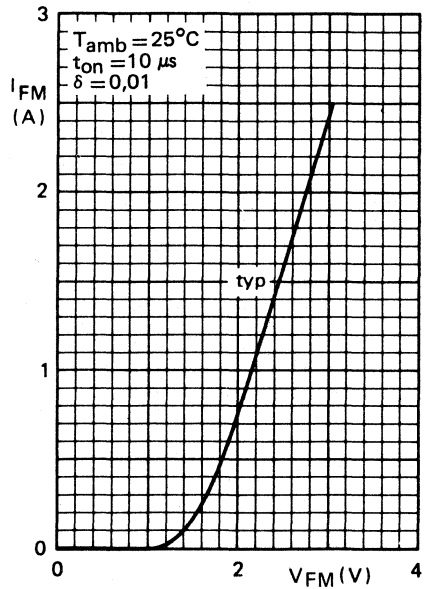

Fig. 7.

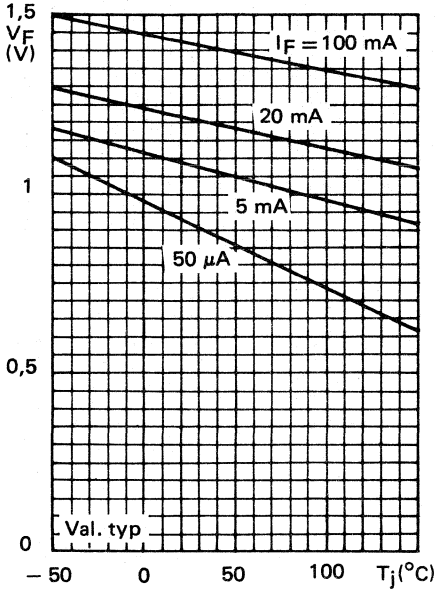

Fig. 8.

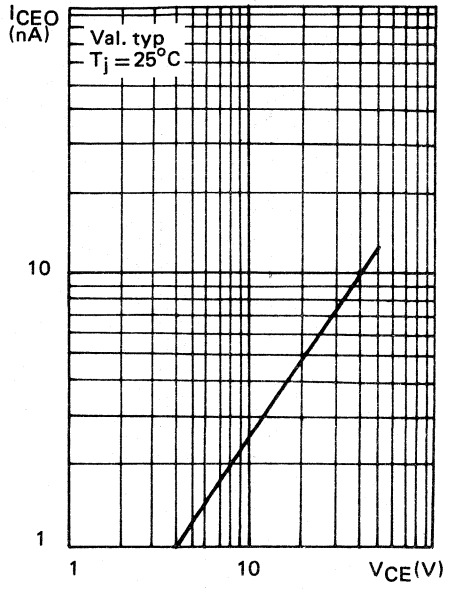

Fig. 9.

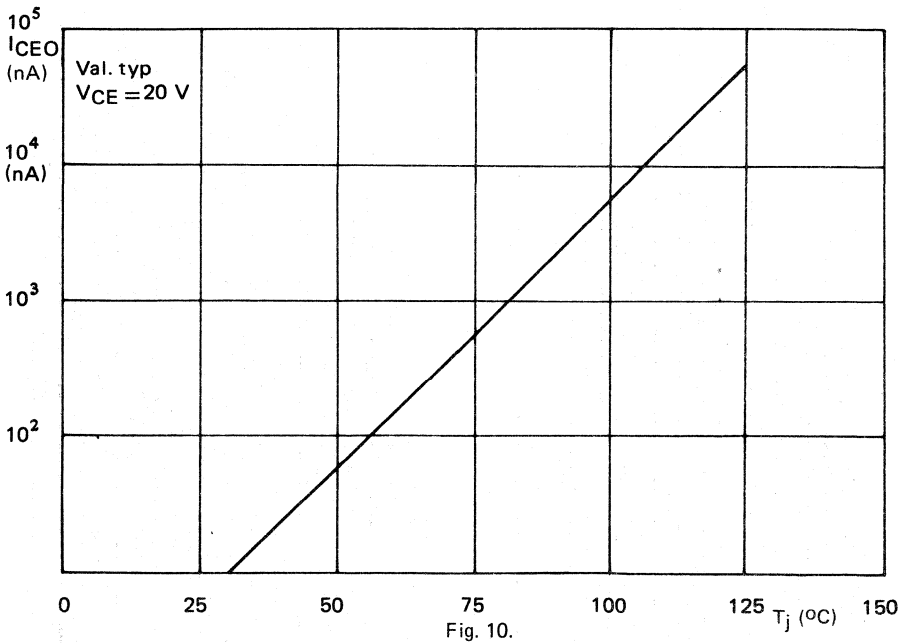

Fig. 10.

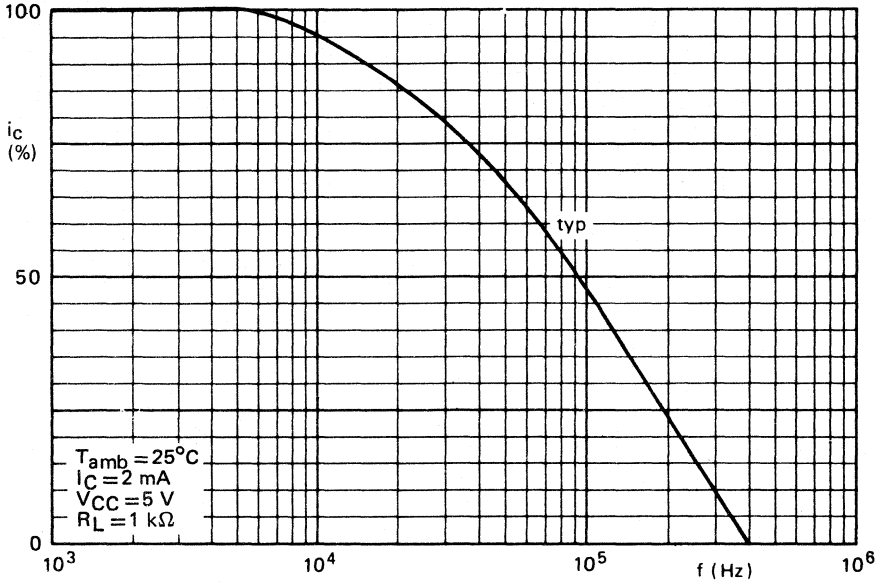

Fig. 11.

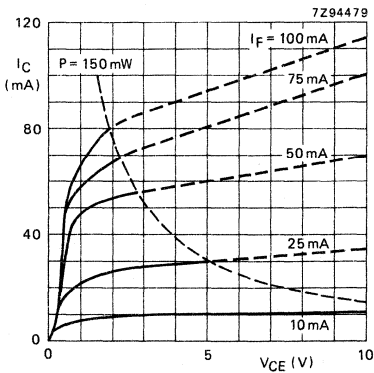

Fig. 12 $T_{amb} = 25^\circ C$; typical values.

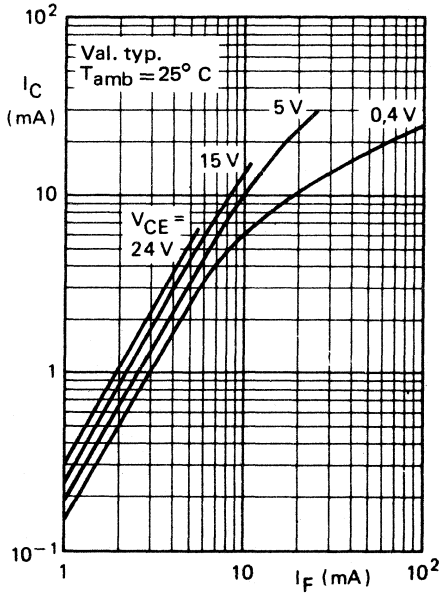

Fig. 13.

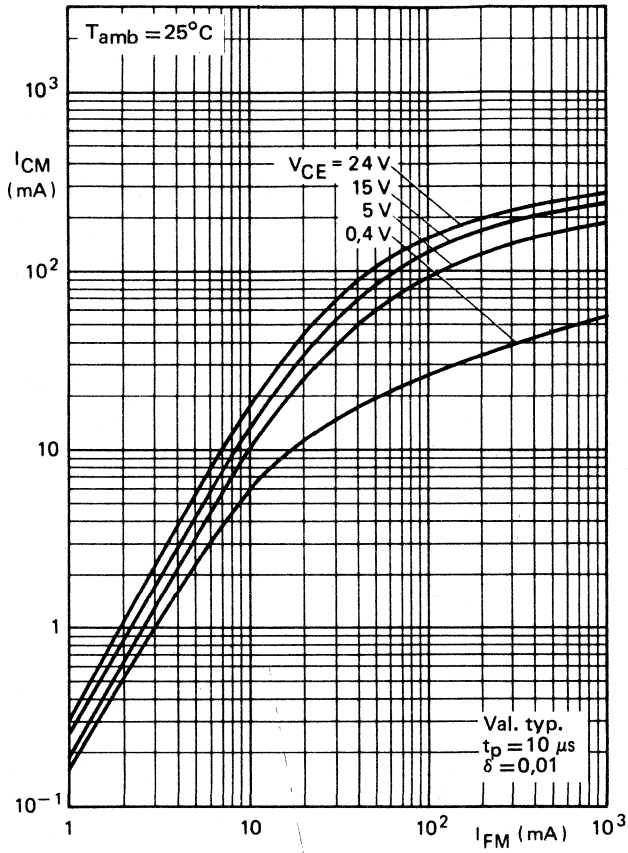

Fig. 14.

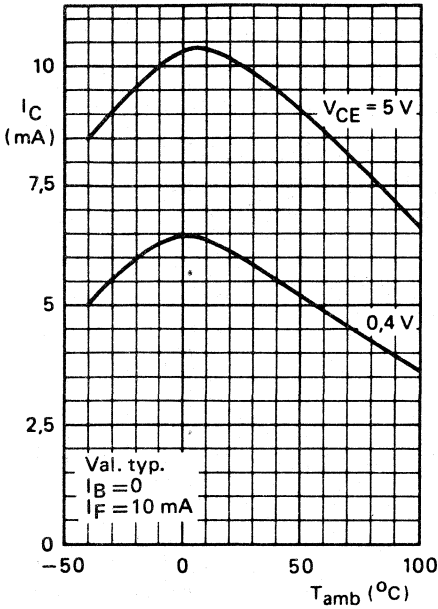

Fig. 15.

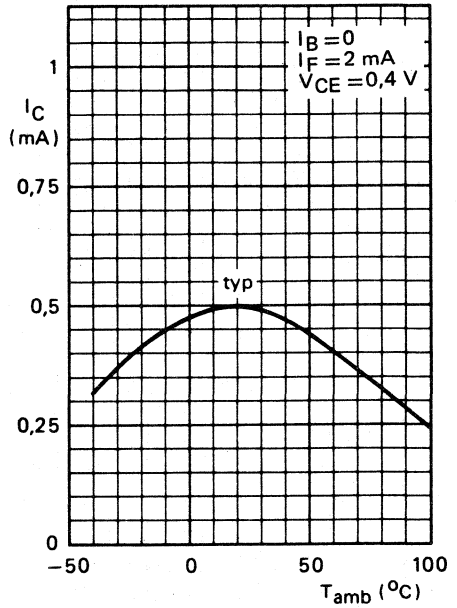

Fig. 16.

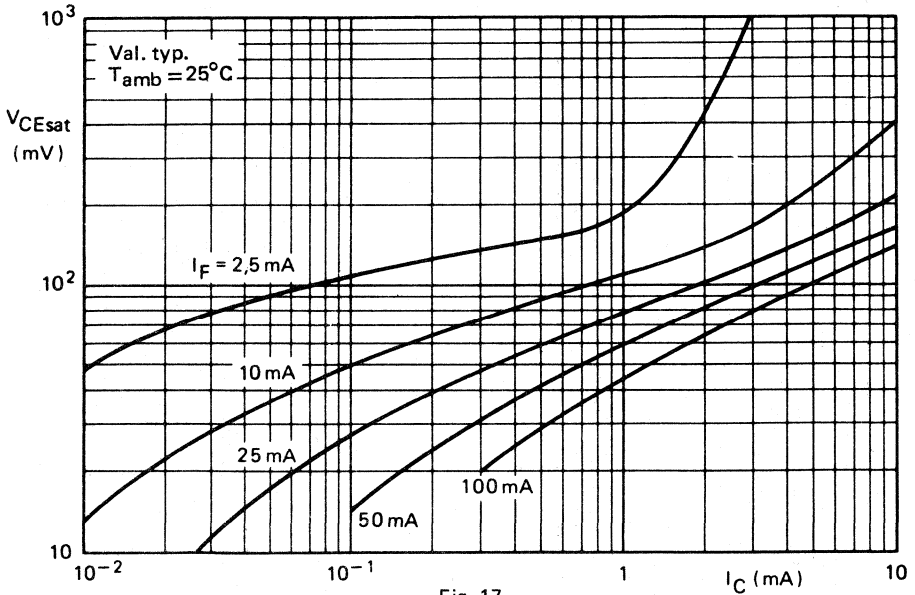

Fig. 17.

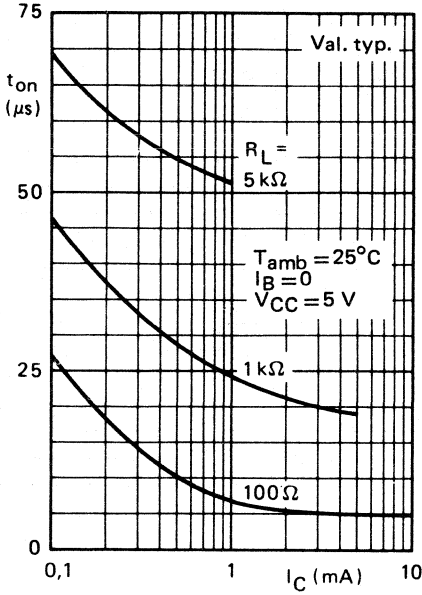

Fig. 18.

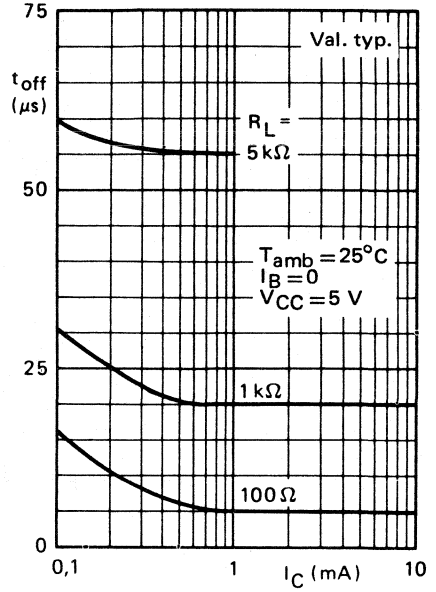

Fig. 19.

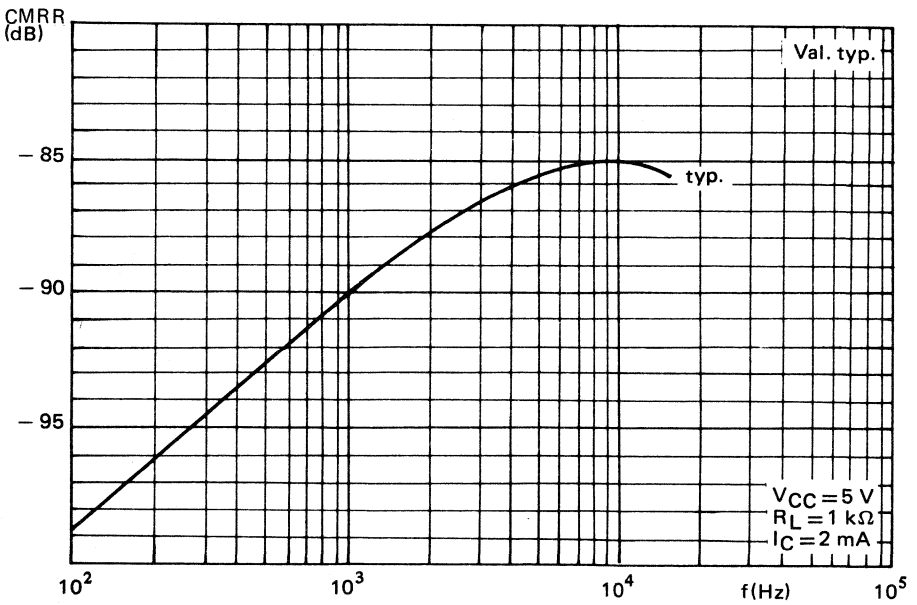

Fig. 20 $T_{amb} = 25^\circ C$.

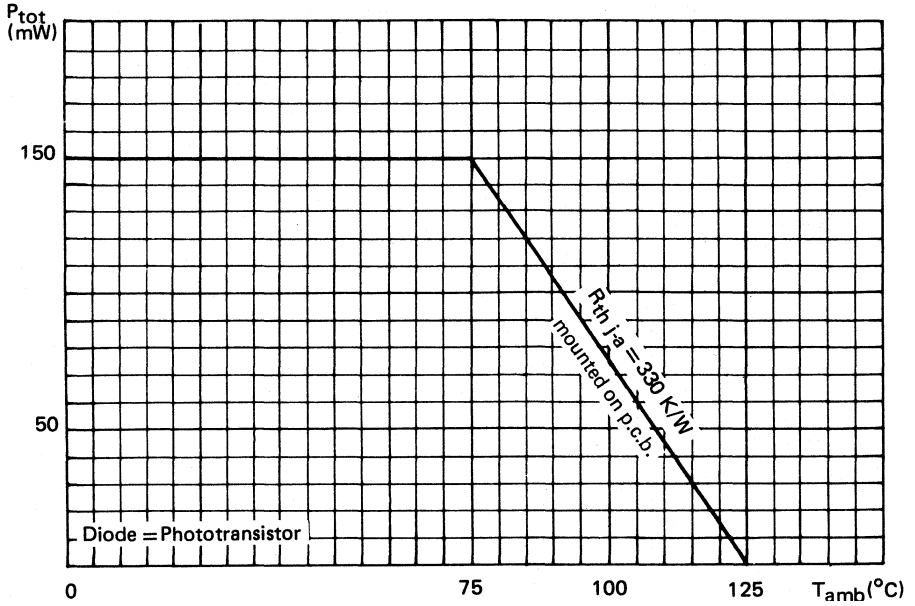

Fig. 21.

OPTOCOUPLER

Optocoupler in a hermetically sealed metal envelope. It has high reliability and can be used under severe conditions such as military or industrial applications.

An outstanding characteristic is the high common-mode rejection ratio.

QUICK REFERENCE DATA

Diode

Forward current d.c. (peak value); $t_p = 10 \mu s$; $\delta = 0,01$	I_F I_{FRM}	max. max.	100 mA 3 A
---	--------------------	--------------	---------------

Transistor

Collector-emitter voltage (open base)	V_{CEO}	max.	60 V
---------------------------------------	-----------	------	------

Optocoupler

Output/input d.c. current transfer ratio (C.T.R.) $I_F = 10 \text{ mA}$; $V_{CE} = 0,4 \text{ V}$	I_C/I_F	min.	0,3
Collector cut-off current (dark) $V_{CE} = 15 \text{ V}$; working voltage (d.c.) = 1,0 kV	I_{CEW}	max.	200 nA
Isolation voltage d.c. value	V_{IORM}	min.	1,0 kV
Common mode rejection ratio $I_C = 2 \text{ mA}$; $f = 10 \text{ kHz}$	CMRR	typ.	85 dB

MECHANICAL DATA

SOT-104C (see Fig. 1).

MECHANICAL DATA

Fig. 1 SOT-104C.

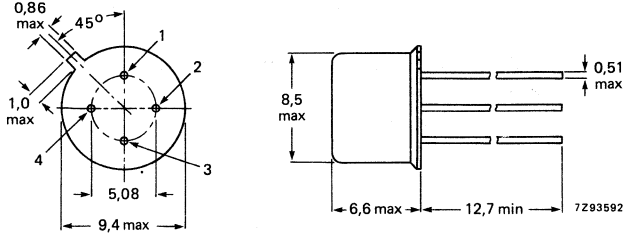

Dimensions in mm

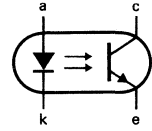

Pinning

- pin 1 = anode
- pin 2 = cathode
- pin 3 = emitter
- pin 4 = collector

RATINGS

Limiting values in accordance with the Absolute Maximum System (IEC 134)

Diode

Continuous reverse voltage	V_R	max.	5 V
Forward current d.c. (peak value); $t_p = 10 \mu s$; $\delta = 0,01$	I_F	max.	100 mA
	I_{FRM}	max.	3 A
Total power dissipation up to $T_{amb} = 75 \text{ }^\circ\text{C}$	P_{tot}	max.	150 mW

Transistor

Collector-emitter voltage (open base)	V_{CEO}	max.	60 V
Emitter-collector voltage (open base)	V_{ECO}	max.	7 V
Collector current	I_C	max.	100 mA
Total power dissipation up to $T_{amb} = 75 \text{ }^\circ\text{C}$	P_{tot}	max.	150 mW

Optocoupler

Total power dissipation up to $T_{amb} = 75 \text{ }^\circ\text{C}$	P_{tot}	max.	300 mW
Storage temperature	T_{stg}		-65 to +150 $^\circ\text{C}$
Operating ambient temperature	T_{amb}		-55 to +125 $^\circ\text{C}$

THERMAL RESISTANCE

From junction to ambient in free air			
diode	$R_{th j-a}$	max.	330 K/W
transistor	$R_{th j-a}$	max.	330 K/W

CHARACTERISTICS

$T_j = 25\text{ }^\circ\text{C}$ unless otherwise specified

Diode

Forward voltage $I_F = 10\text{ mA}$	V_F	typ. max.	1,15 V 1,3 V
Forward voltage $I_F = 2\text{ mA}; T_{amb} = 0\text{ }^\circ\text{C to } 70\text{ }^\circ\text{C}$	V_F	max.	1,2 V
Reverse current $V_R = 5\text{ V}$	I_R	typ. max.	1 μA 100 μA

Transistor

Collector-emitter breakdown voltage open base; $I_C = 1\text{ mA}$	$V_{(BR)CEO}$	min.	60 V
Emitter-collector breakdown voltage open base; $I_E = 0,1\text{ mA}$	$V_{(BR)ECO}$	min.	7 V
Collector cut-off current (dark) $V_{CE} = 20\text{ V}$	I_{CEO}	typ. max.	5 nA 100 nA
$V_{CE} = 20\text{ V}; T_a = 70\text{ }^\circ\text{C}$	I_{CEO}	max.	10 μA
D.C. current gain $I_C = 10\text{ mA}; V_{CE} = 5\text{ V}$	h_{FE}	typ.	600

Optocoupler

Output/input d.c. current transfer ratio (C.T.R.) $I_F = 10\text{ mA}; V_{CE} = 0,4\text{ V}$	I_C/I_F	min. typ.	0,4 0,8
$I_F = 10\text{ mA}; V_{CE} = 5\text{ V}$	I_C/I_F	typ.	1,0
Switching times $I_C = 2\text{ mA}; V_{CC} = 5\text{ V}; R_L = 100\ \Omega$			
Turn-on time	t_{on}	typ.	5 μs
Turn-off time	t_{off}	typ.	5 μs
Isolation voltage, d.c. value between shorted input leads and shorted output leads	V_{IORM}	min.	1,0 kV
Collector cut-off current (dark) $V_{CC} = 15\text{ V};$ working voltage (d.c.) = 1 kV $T_j = 25\text{ }^\circ\text{C}$ $T_j = 70\text{ }^\circ\text{C}$ (see Fig. 3)	I_{CEW} I_{CEW}	max. max.	200 nA* 50 μA *
Insulation resistance between input and output $V_{IO} = 500\text{ V}$	R_{IO}	min. typ.	$10^{11}\ \Omega$ $10^{12}\ \Omega$
Capacitance between input and output $V = 0; f = 1\text{ MHz}$	C_{IO}	typ.	1 pF

* As quality assurance (on a sample basis), these parameters are covered by a 1000 h reliability test.

Common mode rejection ratio
 $I_C = 2 \text{ mA}$; $f = 10 \text{ kHz}$
(see Fig. 2)

CMRR typ. 85 dB

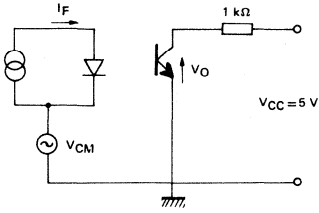

Fig. 2.

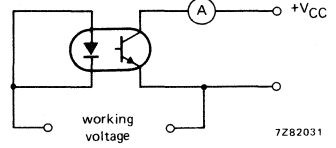

Fig. 3

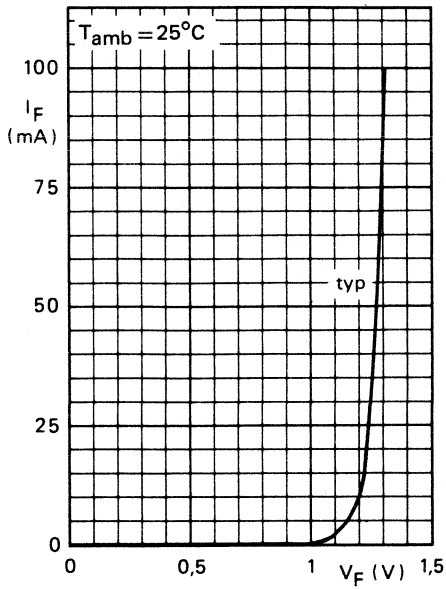

Fig. 4 Typical values.

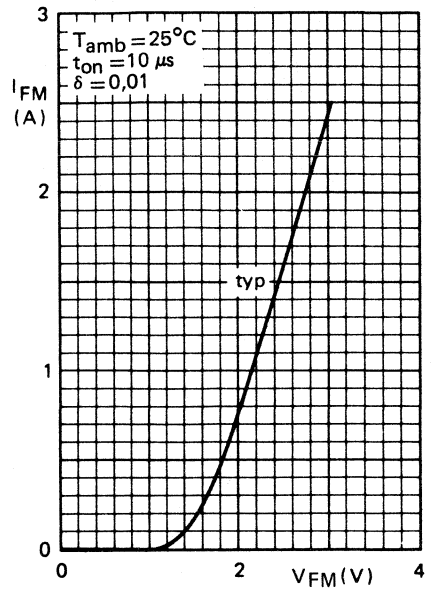

Fig. 5 Typical values.

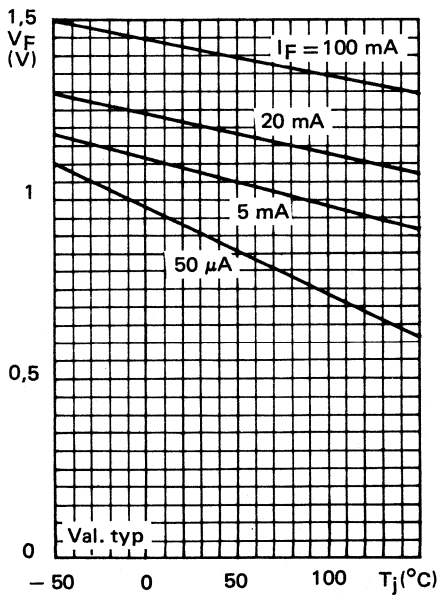

Fig. 6 Typical values.

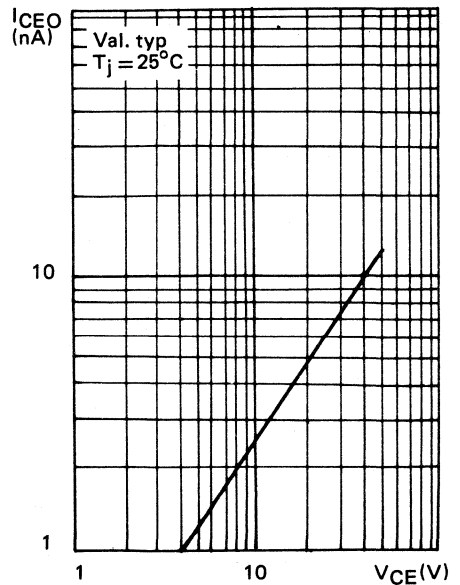

Fig. 7 Typical values.

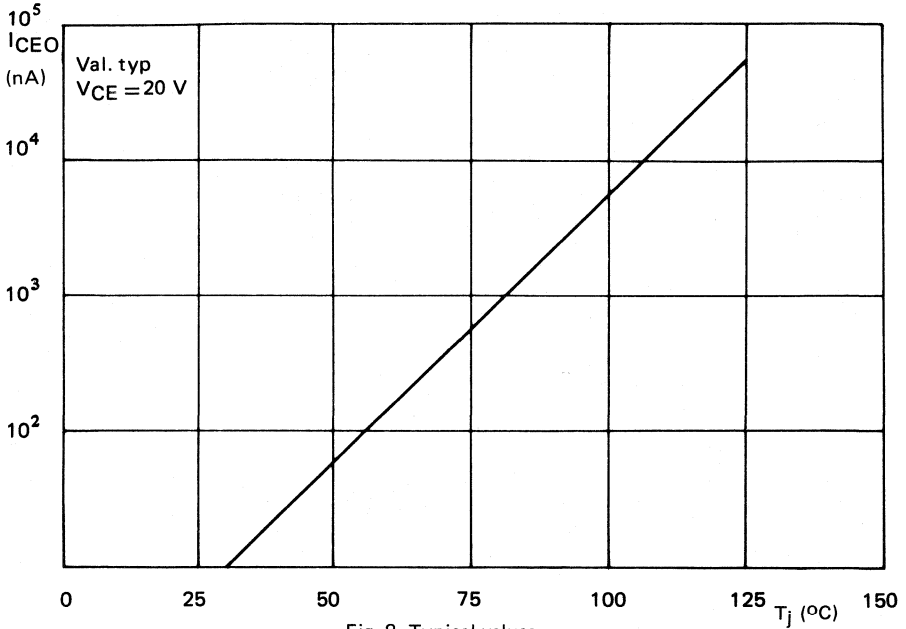

Fig. 8 Typical values.

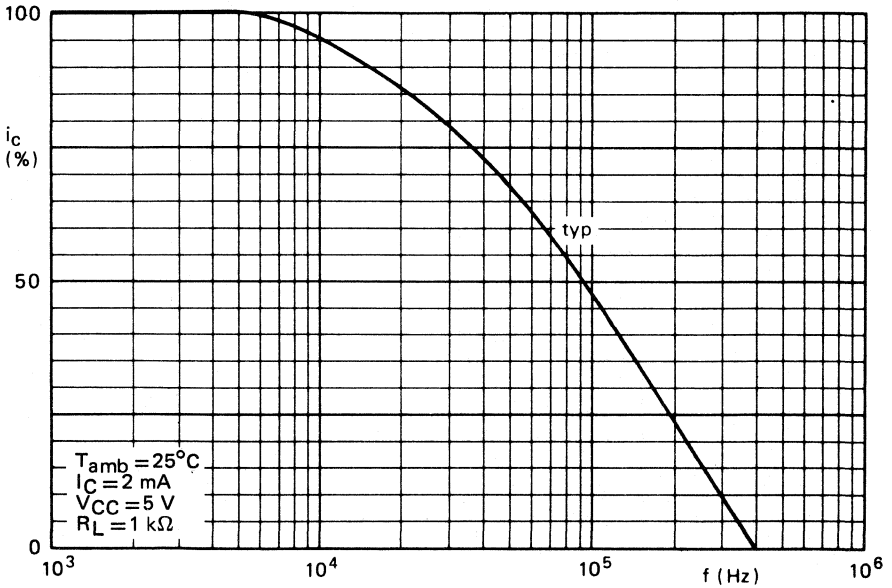

Fig. 9 Typical values.

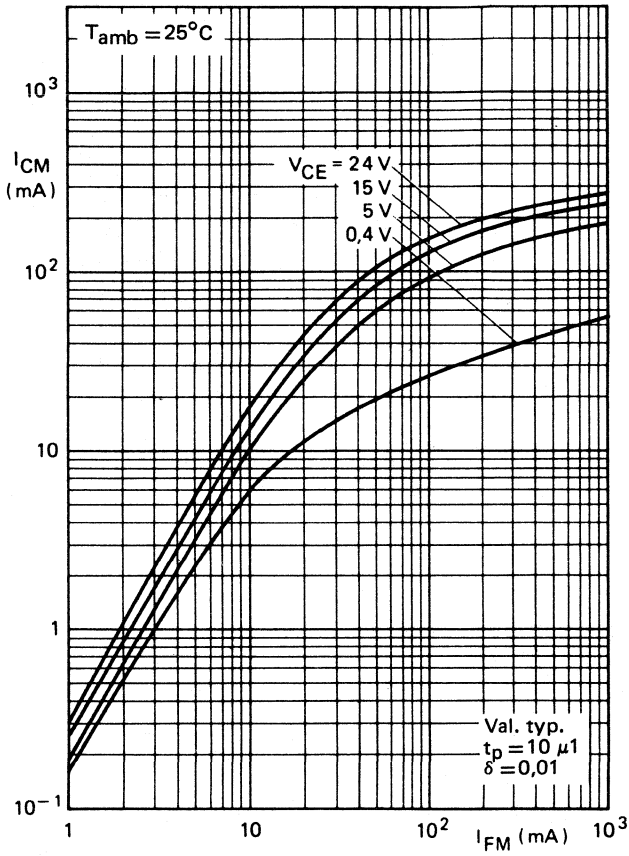

Fig. 10 Typical values.

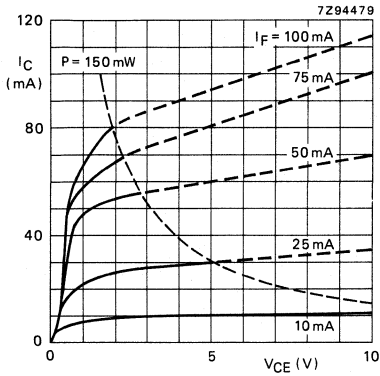

Fig. 11 $T_{amb} = 25^\circ\text{C}$; typical values.

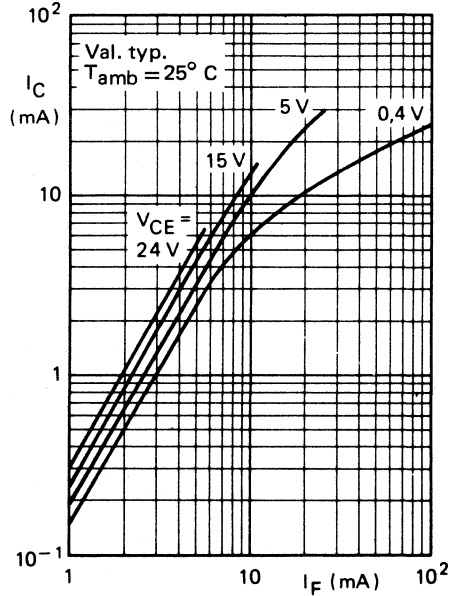

Fig. 12 Typical values.

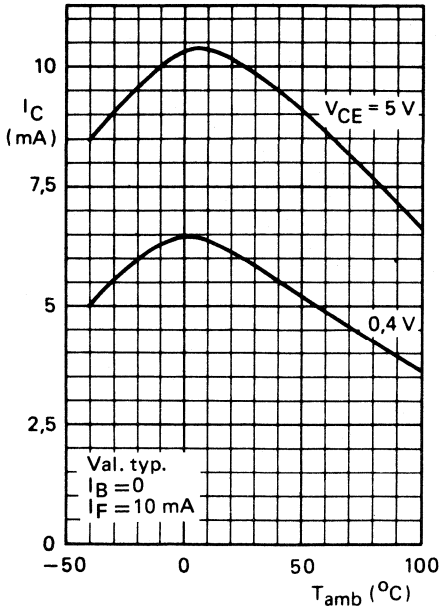

Fig. 13 Typical values.

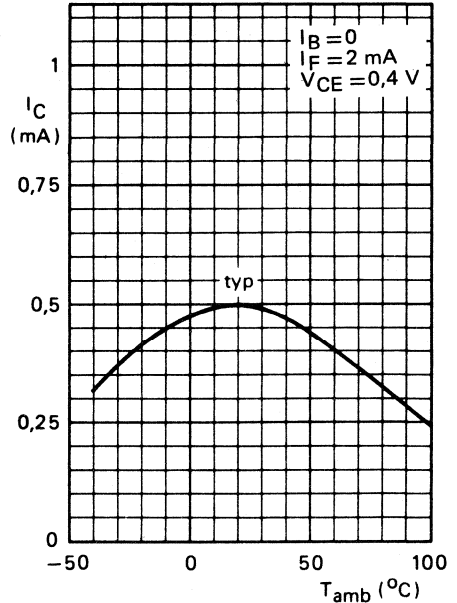

Fig. 14 Typical values.

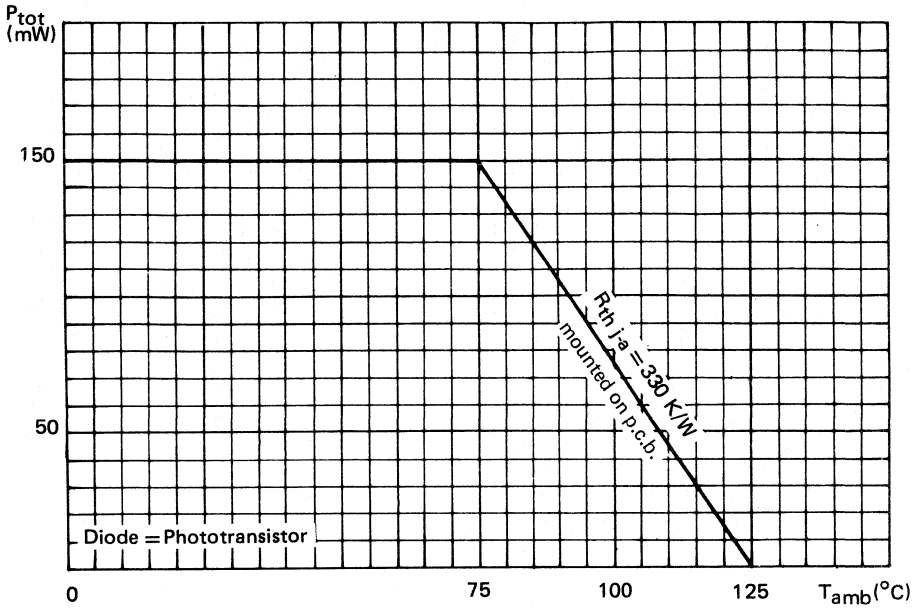

Fig. 15 Typical values.

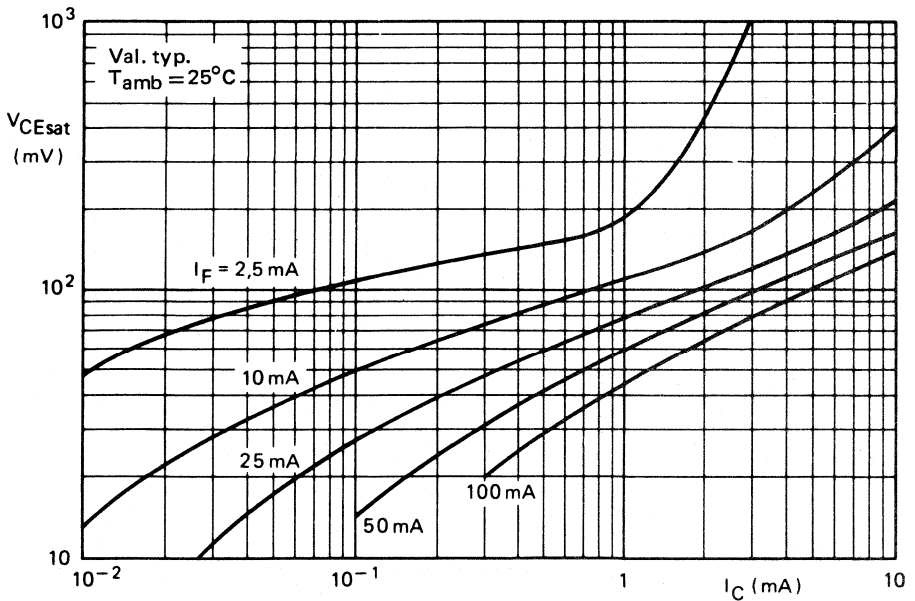

Fig. 16 Typical values.

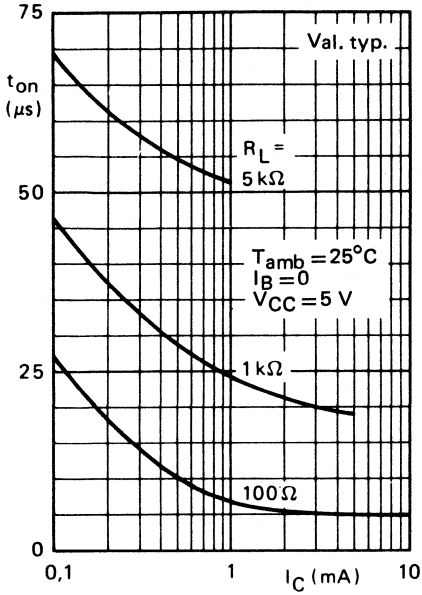

Fig. 17 Typical values.

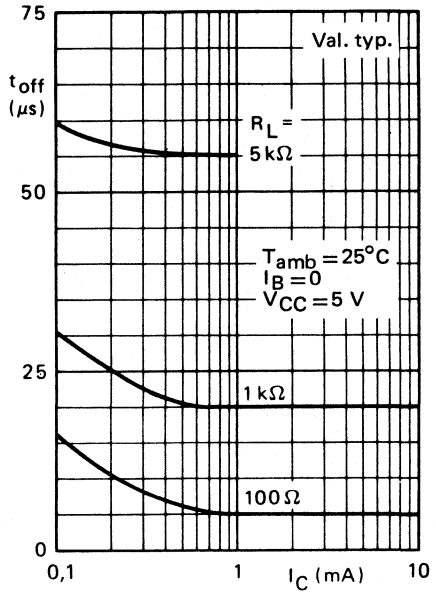

Fig. 18 Typical values.

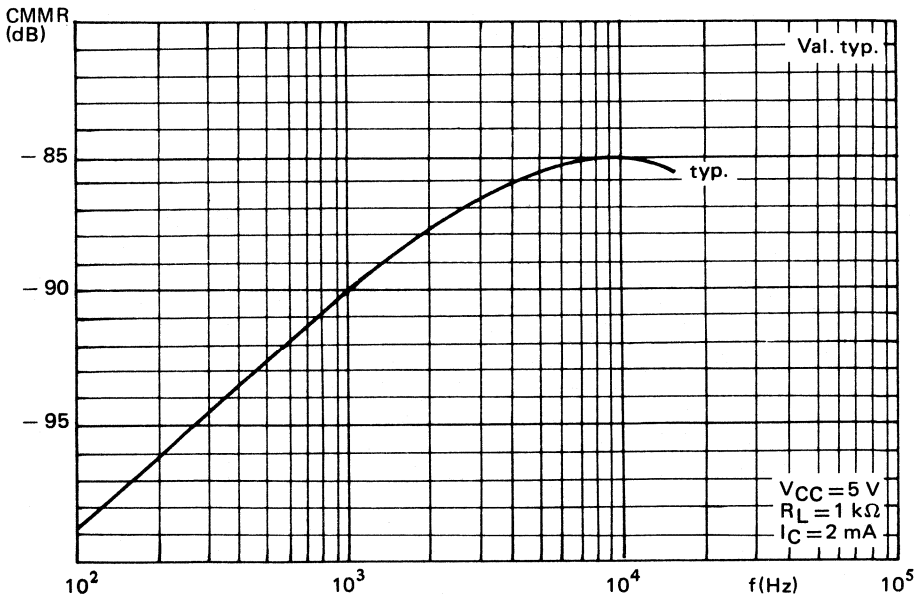

Fig. 19 $T_{amb} = 25^\circ C$; typical values.

OPTOCOUPLERS

Optically coupled isolators consisting of an infrared emitting GaAlAs diode and a silicon n-p-n phototransistor. Hermetically sealed in a SOT-18F envelope, the CNX91 and CNX92 are intended for professional applications.

The difference between the two types is the pinning of the phototransistor.

QUICK REFERENCE DATA

Diode

Continuous reverse voltage	V_R	max.	5 V
Forward current			
d.c.	I_F	max.	100 mA
(peak value); $t_p = 10 \mu s$; $\delta = 0,01$	I_{FRM}	max.	2,5 A

Transistor

Collector-emitter voltage (open base)	V_{CEO}	max.	50 V
Collector current	I_C	max.	100 mA

Optocoupler

Leakage current under working voltage 500 V d.c. value $V_{CE} = 15 V$ $T_j = 25 \text{ }^\circ C$ $T_j = 70 \text{ }^\circ C$	I_{CEW} I_{CEW}	max. max.	200 nA 100 μA
Isolation voltage d.c. value	V_{IORM}	min.	0,8 kV
Common mode rejection ratio $I_C = 2 \text{ mA}$; $f = 10 \text{ kHz}$	CMRR	min.	80 dB

MECHANICAL DATA

SOT-18F (see Fig. 1).

MECHANICAL DATA

Fig. 1 SOT-18F.

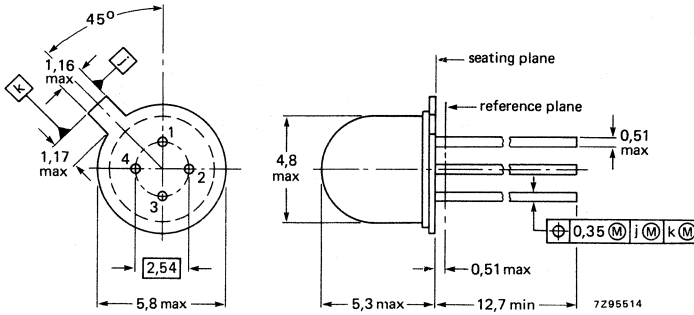

Dimensions in mm

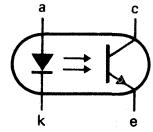

Pin reference

CNX91

- pin 1 = anode
- pin 2 = collector
- pin 3 = emitter
- pin 4 = cathode

CNX92

- pin 1 = anode
- pin 2 = emitter
- pin 3 = collector
- pin 4 = cathode

RATINGS

Limiting values in accordance with the Absolute Maximum System (IEC 134)

Diode

Continuous reverse voltage	V_R	max.	5 V
Forward current			
d.c.	I_F	max.	100 mA
(peak value); $t_p = 10 \mu s$; $\delta = 0,01$	I_{FRM}	max.	2,5 A

Transistor

Collector-emitter voltage (open base)	V_{CEO}	max.	50 V
Emitter-collector voltage (open base)	V_{ECO}	max.	7 V
Collector current	I_C	max.	100 mA

Optocoupler

Total power dissipation up to $T_{amb} = 25 \text{ }^\circ\text{C}$	P_{tot}	max.	230 mW
Storage temperature	T_{stg}		-65 to +150 $^\circ\text{C}$
Operating ambient temperature	T_{amb}		-55 to +125 $^\circ\text{C}$
Soldering temperature 2 mm from the seating plane; < 10 s	T_{sld}		260 $^\circ\text{C}$

THERMAL RESISTANCE

From junction to ambient in free air			
diode	$R_{th\ j-a}$	max.	600 K/W
transistor	$R_{th\ j-a}$	max.	500 K/W
From junction to case			
diode	$R_{th\ j-c}$	max.	300 K/W
transistor	$R_{th\ j-c}$	max.	200 K/W

CHARACTERISTICS

$T_j = 25\text{ }^\circ\text{C}$ unless otherwise specified

Diode

Forward voltage			
$I_F = 2\text{ mA}$	V_F	max.	1,5 V
$I_F = 10\text{ mA}$	V_F	max.	1,65 V
$I_F = 50\text{ mA}$	V_F	max.	1,80 V
Reverse current			
$V_R = 5\text{ V}$	I_R	max.	100 μA
Diode capacitance	C_d	typ.	200 pF

Transistor

Collector-emitter breakdown voltage			
open base; $I_C = 1\text{ mA}$	$V_{(BR)CEO}$	min.	50 V
Emitter-collector breakdown voltage			
open base; $I_E = 0,1\text{ mA}$	$V_{(BR)ECO}$	min.	7 V
Collector cut-off current (dark)			
$V_{CE} = 50\text{ V}$	I_{CEO}	typ.	5 nA
$V_{CE} = 5\text{ V}$	I_{CEO}	max.	50 nA
	I_{CEO}	max.	10 nA

Optocoupler

Collector current			
$I_F = 10\text{ mA}$; $V_{CE} = 0,4\text{ V}$	I_C	min.	3 mA
		max.	20 mA
Saturation voltage			
$I_F = 50\text{ mA}$; $I_C = 10\text{ mA}$	V_{CEsat}	max.	0,4 V
Switching times			
$I_C = 2\text{ mA}$; $V_{CC} = 5\text{ V}$; $R_L = 100\ \Omega$			
Delay time	t_d	typ.	2 μs
		max.	4 μs
Rise time	t_r	typ.	4 μs
		max.	5 μs
Storage time	t_s	typ.	0,4 μs
		max.	0,5 μs
Fall time	t_f	typ.	4 μs
		max.	5 μs
Isolation voltage, d.c. value			
connected between shorted input			
leads and shorted output leads	V_{IORM}	min.	0,8 kV

Collector cut-off current (dark)

$V_{CE} = 15 \text{ V}$;
working voltage (d.c.) = 500 V
 $T_j = 25 \text{ }^\circ\text{C}$
 $T_j = 70 \text{ }^\circ\text{C}$
(see Fig. 3)

I_{CEW}	max.	200 nA
I_{CEW}	max.	100 μA

Insulation resistance between input
and output

$V_{IO} = 500 \text{ V}$

r_{IO}	min.	$10^{12} \text{ } \Omega$
----------	------	---------------------------

Capacitance between input and output

$V = 0$; $f = 1 \text{ MHz}$

C_{io}	typ.	1 pF
	max.	2 pF

Common mode rejection ratio

$I_C = 2 \text{ mA}$; $f = 10 \text{ kHz}$
(see Fig. 2)

CMRR	min.	80 dB
	typ.	90 dB

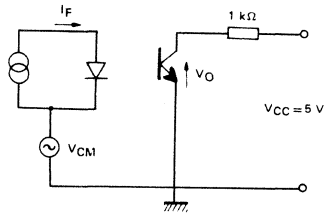

Fig. 2.

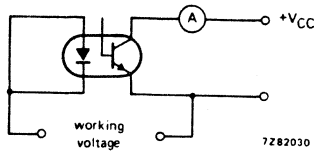

Fig. 3.

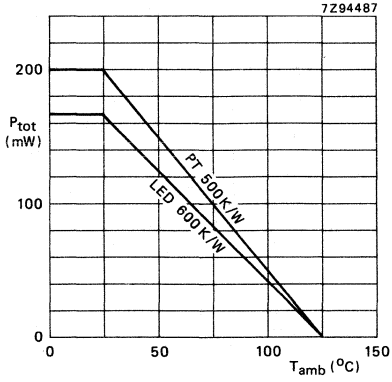

Fig. 4 Power derating curve.

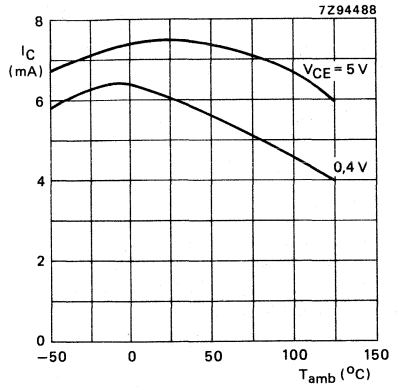

Fig. 5 $I_F = 10$ mA; typical values.

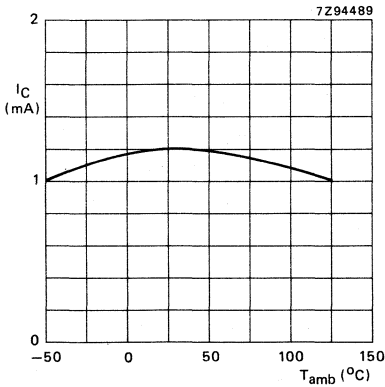

Fig. 6 $I_F = 2$ mA; $V_{CE} = 5$ V; typical values.

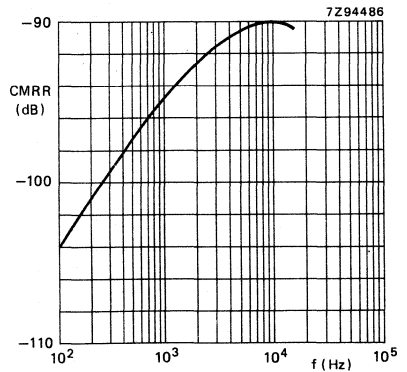

Fig. 7 $I_C = 2$ mA, $V_{CE} = 5$ V; $R_L = 1$ k Ω ; typical values.

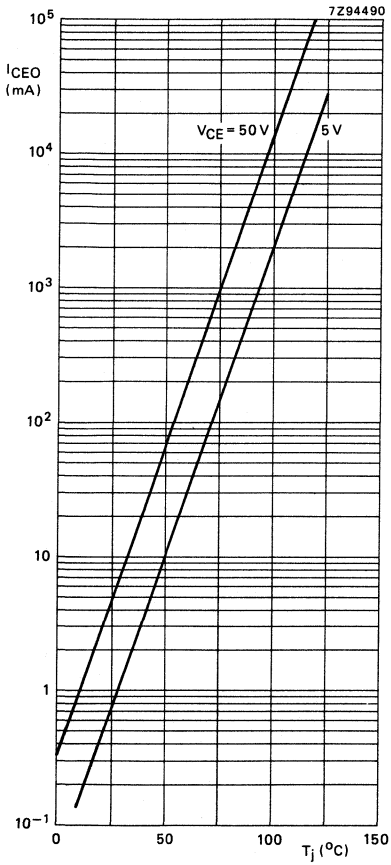

Fig. 8 $T_{amb} = 25\text{ }^\circ\text{C}$; typical values.

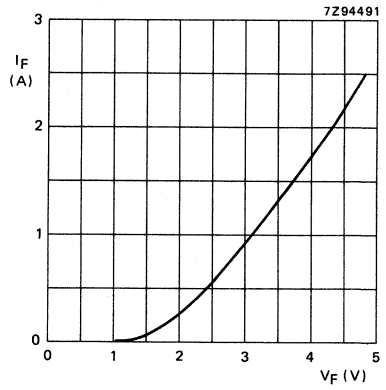

Fig. 9 $T_{amb} = 25\text{ }^\circ\text{C}$; $\delta = 0,01$; $T_{on} = 10\text{ }\mu\text{s}$; typical values.

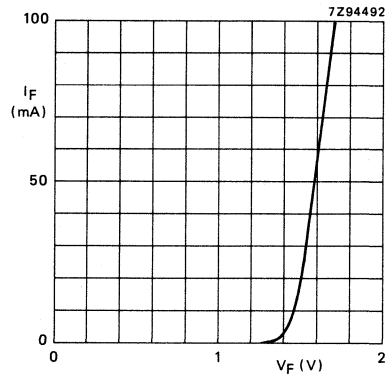

Fig. 10 $T_{amb} = 25\text{ }^\circ\text{C}$; typical values.

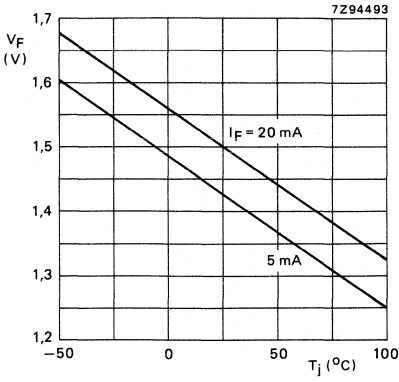

Fig. 11 Typical values.

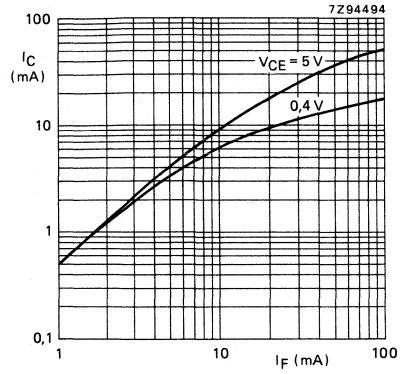

Fig. 12 $T_{amb} = 25$ °C; typical values.

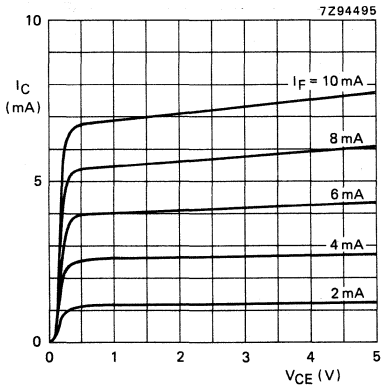

Fig. 13 Typical values.

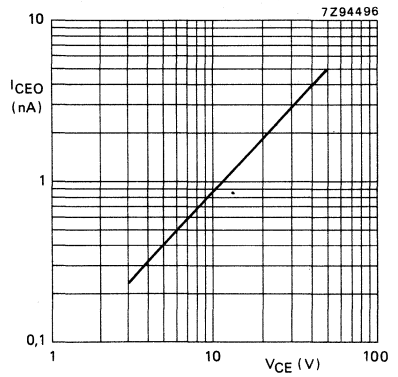

Fig. 14 $T_j = 25$ °C; typical values.

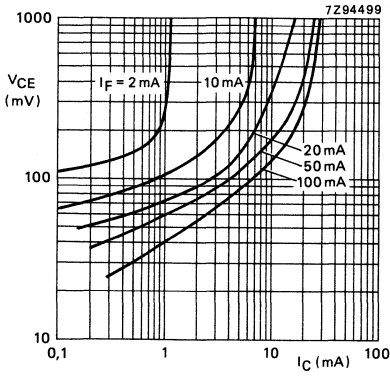

Fig. 15 $T_{amb} = 25^\circ C$; $V_{CC} = 5 V$; typical values.

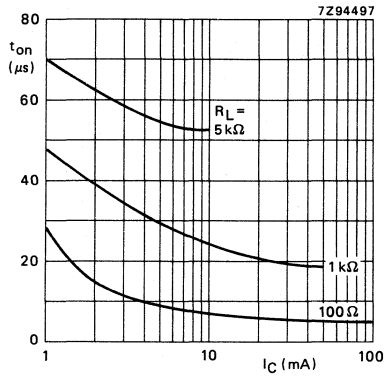

Fig. 16 $V_{CC} = 5 V$; typical values.

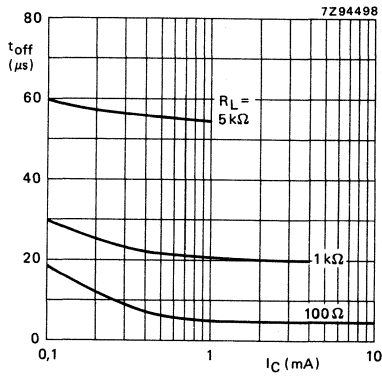

Fig. 17 $T_{amb} = 25^\circ C$; typical values.

OPTOCOUPLER

Optically coupled isolator consisting of an infrared emitting GaAs diode and a silicon n-p-n photo-transistor with accessible base. Hermetically encapsulated in a metal envelope. The CNY50 is intended for professional applications.

QUICK REFERENCE DATA

Diode

Continuous reverse voltage	V_R	max.	5 V
Forward current d.c. (peak value); $t_p = 10 \mu s$; $\delta = 0,01$	I_F	max.	100 mA
	I_{FRM}	max.	3 A
Total power dissipation up to $T_{amb} = 75 \text{ }^\circ\text{C}$	P_{tot}	max.	150 mW

Transistor

Collector-emitter voltage (open base)	V_{CEO}	max.	50 V
Total power dissipation up to $T_{amb} = 75 \text{ }^\circ\text{C}$	P_{tot}	max.	150 mW

Optocoupler

Output/input d.c. current transfer ratio (C.T.R.)
 $I_F = 10 \text{ mA}$; $V_{CE} = 0,4 \text{ V}$; ($I_B = 0$)

CNY50-1	I_C/I_F	min.	0,25
		max.	1,0
CNY50-2	I_C/I_F	min.	0,4
		max.	1,6

Collector cut-off current (dark)

$V_{CC} = 15 \text{ V}$; working voltage (d.c.) = 1 kV

I_{CEW}	max.	200 nA
-----------	------	--------

Isolation voltage(d.c.)

V_{IORM}	min.	1,5 kV
------------	------	--------

MECHANICAL DATA

Fig. 1 SOT-104B.

Dimensions in mm

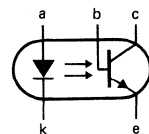
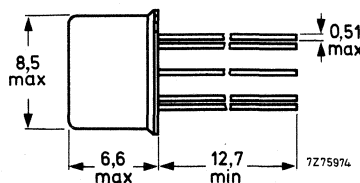
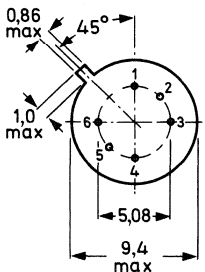

Lead reference
 pin 1 = emitter
 pin 2 = base
 pin 3 = collector
 pin 4 = anode
 pin 5 = N.C.
 pin 6 = cathode

Maximum lead diameter guaranteed only for 12,7 mm.

→ RATINGS

Limiting values in accordance with the Absolute Maximum System (IEC 134)

Diode

Continuous reverse voltage	V_R	max.	5 V
Forward current			
d.c.	I_F	max.	100 mA
(peak value); $t_p = 10 \mu s$; $\delta = 0,01$	I_{FRM}	max.	3 A
Total power dissipation up to $T_{amb} = 75 \text{ }^\circ\text{C}$ (see Fig. 2)	P_{tot}	max.	150 mW
Operating junction temperature	T_j	max.	125 $^\circ\text{C}$

Transistor

Collector-base voltage (open emitter)	V_{CBO}	max.	70 V
Collector-emitter voltage (open base)	V_{CEO}	max.	50 V
Emitter-collector voltage (open base)	V_{ECO}	max.	7 V
Collector current (d.c.)	I_C	max.	100 mA
Total power dissipation up to $T_{amb} = 75 \text{ }^\circ\text{C}$	P_{tot}	max.	150 mW
Operating junction temperature	T_j	max.	125 $^\circ\text{C}$

Optocoupler

Total power dissipation up to $T_{amb} = 75 \text{ }^\circ\text{C}$	P_{tot}	max.	300 mW
Storage temperature	T_{stg}		-65 to +150 $^\circ\text{C}$
Operating ambient temperature	T_{amb}		-55 to +125 $^\circ\text{C}$

THERMAL RESISTANCE

From junction to ambient in free air

diode	$R_{th j-a}$	=	330 K/W
transistor	$R_{th j-a}$	=	330 K/W

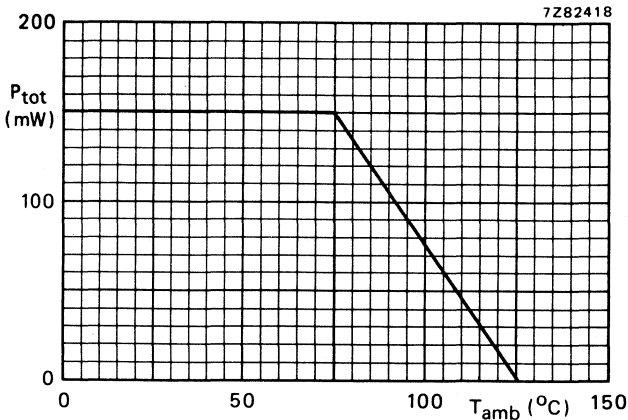

Fig. 2 Power/temperature derating curve for diode and transistor.

CHARACTERISTICS $T_j = 25\text{ }^\circ\text{C}$ unless otherwise specified**Diode**

Forward voltage

 $I_F = 2\text{ mA}; T_{\text{amb}} = 0\text{ }^\circ\text{C to } 70\text{ }^\circ\text{C}$

V_F	<	1,2 V
	typ.	1,15 V

 $I_F = 10\text{ mA}$

V_F	<	1,3 V
-------	---	-------

Reverse current

 $V_R = 5\text{ V}$

I_R	typ.	1 μA
	<	20 μA

Diode capacitance

 $V_R = 0; f = 1\text{ MHz}$

C_d	typ.	75 pF
-------	------	-------

Transistor (diode: $I_F = 0$)

Collector-base breakdown voltage

open emitter; $I_C = 0,1\text{ mA}$

$V_{(BR)CBO}$	>	70 V
---------------	---	------

Collector-emitter breakdown voltage

open base; $I_C = 1\text{ mA}$

$V_{(BR)CEO}$	>	50 V
---------------	---	------

Emitter-collector breakdown voltage

open base; $I_E = 0,1\text{ mA}$

$V_{(BR)ECO}$	>	7 V
---------------	---	-----

Collector cut-off current (dark)

 $I_E = 0; V_{CB} = 10\text{ V}$

I_{CBO}	<	20 nA
-----------	---	-------

 $I_B = 0; V_{CE} = 20\text{ V}$

I_{CEO}	typ.	5 nA
-----------	------	------

 $I_B = 0; V_{CE} = 20\text{ V}; T_{\text{amb}} = 70\text{ }^\circ\text{C}$

I_{CEO}	<	100 nA
-----------	---	--------

I_{CEO}	<	10 μA
-----------	---	------------------

D.C. current gain

 $I_C = 10\text{ mA}; V_{CE} = 5\text{ V}$

h_{FE}	min.	200
	typ.	600

Optocoupler ($I_B = 0$)

Output/input d.c. current transfer ratio (C.T.R.)

 $I_F = 10\text{ mA}; V_{CE} = 0,4\text{ V}$

CNY50-1	I_C/I_F	min.	0,25
		typ.	0,4
		max.	1,0

CNY50-2	I_C/I_F	min.	0,4
		typ.	0,8
		max.	1,6

Collector cut-off current (dark) see Fig. 3

 $V_{CC} = 15\text{ V};$ working voltage (d.c.) = 1 kV $T_j = 25\text{ }^\circ\text{C}$ $T_j = 70\text{ }^\circ\text{C}$

I_{CEW}	<	200 nA
-----------	---	--------

I_{CEW}	<	100 μA
-----------	---	-------------------

Isolation voltage, d.c. value

between shorted input
and shorted output terminals

V_{IORM}	min.	1,5 kV
------------	------	--------

Capacitance between input and output

 $I_F = 0; V = 0; f = 1\text{ MHz}$

C_{io}	typ.	1 pF
	max.	2,5 pF

Insulation resistance between input and output
 $\pm V_{IO} = 500 \text{ V}$

r_{IO}	>	$10^{11} \Omega$
	typ.	$10^{12} \Omega$

Switching times

$I_F = 10 \text{ mA}$; $V_{CC} = 5 \text{ V}$; $R_L = 2 \text{ k}\Omega$

t_{on}	typ.	$20 \mu\text{s}$
t_{off}	typ.	$70 \mu\text{s}$

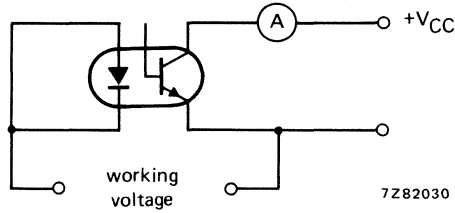
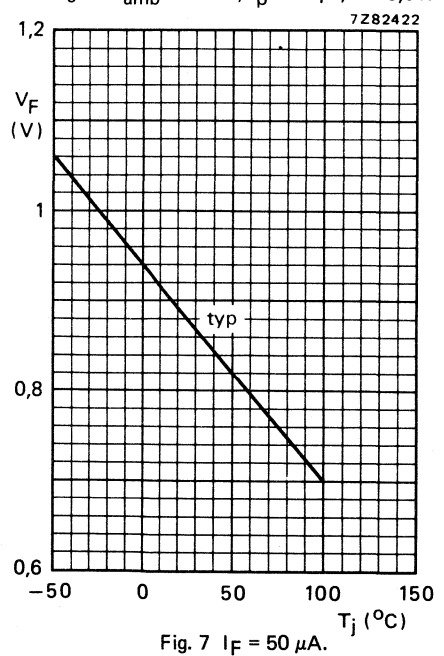
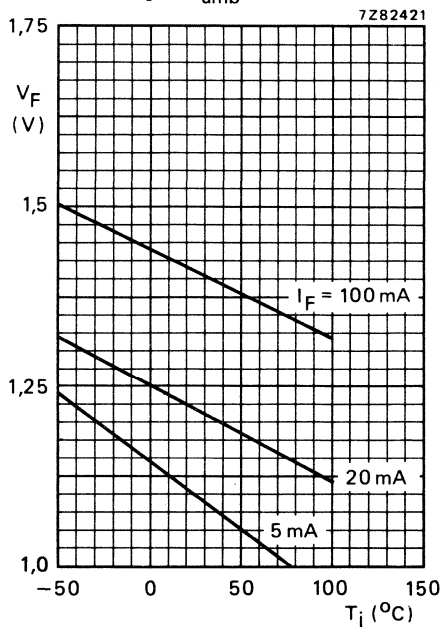
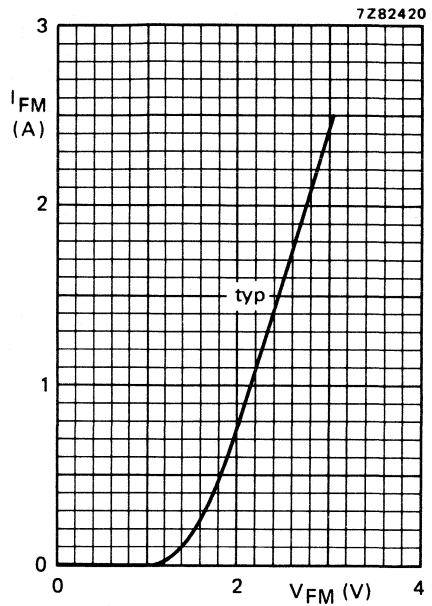
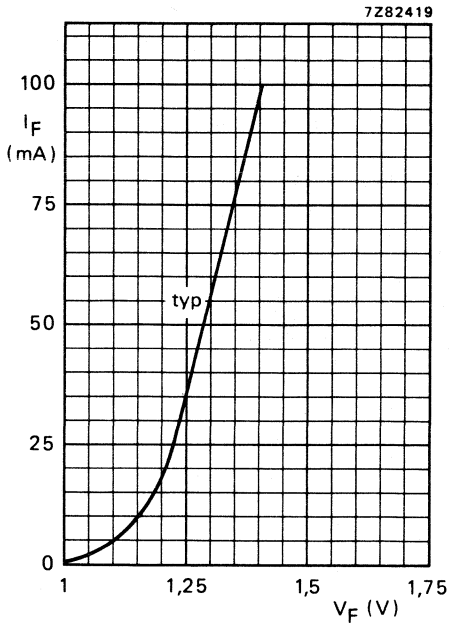

Fig. 3.



7Z82433

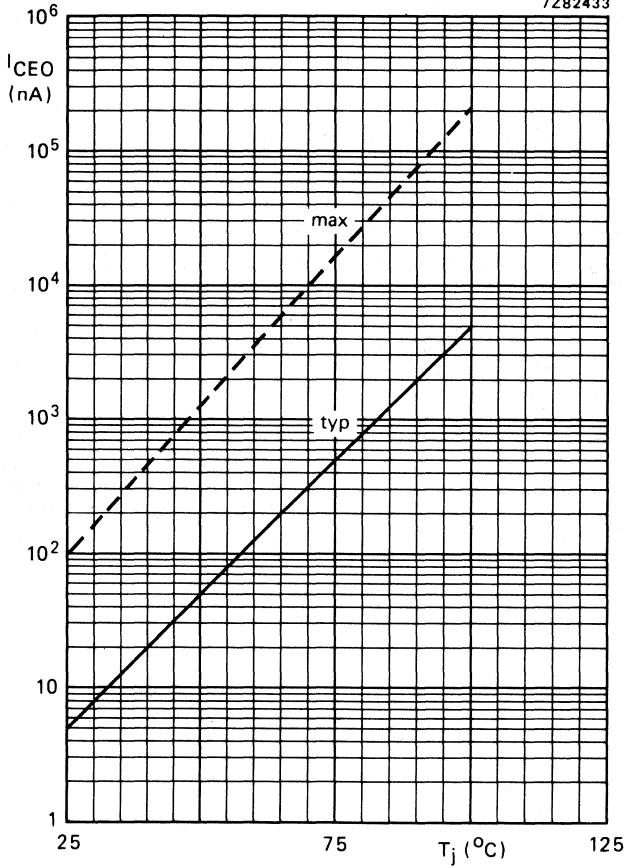

Fig. 8 $I_F = 0$; $V_{CE} = 20$ V.

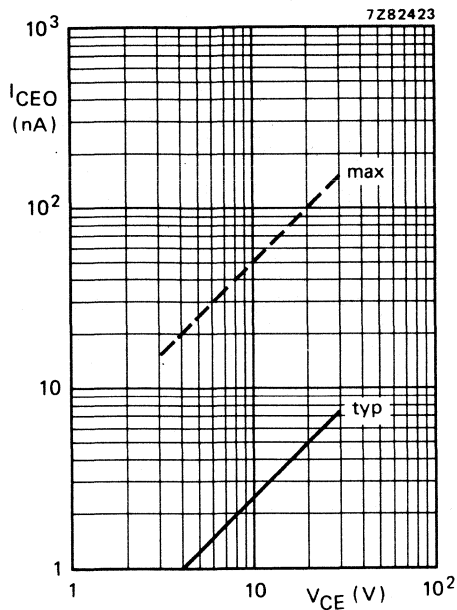

Fig. 9 $I_F = 0$; $T_j = 25^\circ\text{C}$.

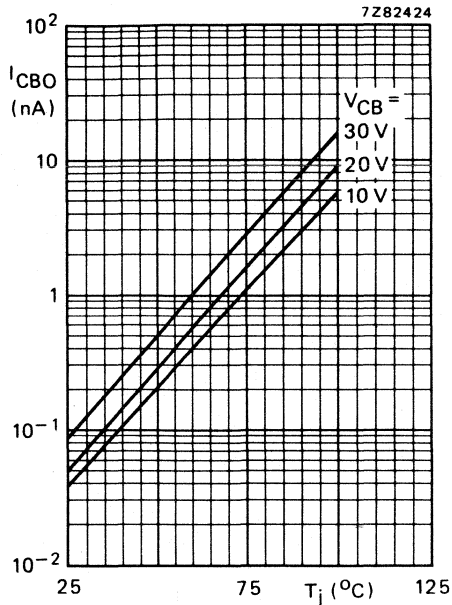

Fig. 10 $I_F = 0$; typical values.

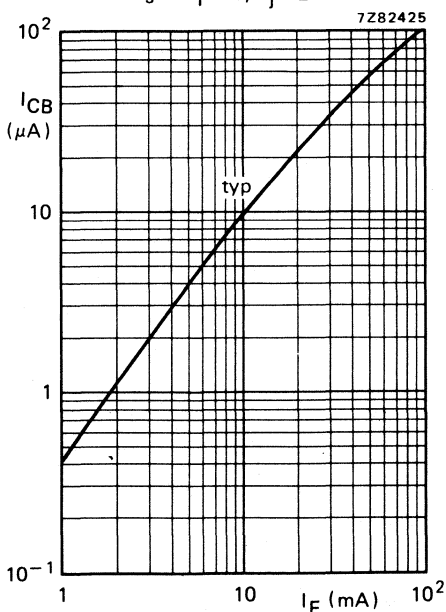

Fig. 11 $I_E = 0$; $V_{CB} = 5\text{ V}$; $T_{amb} = 25^\circ\text{C}$.

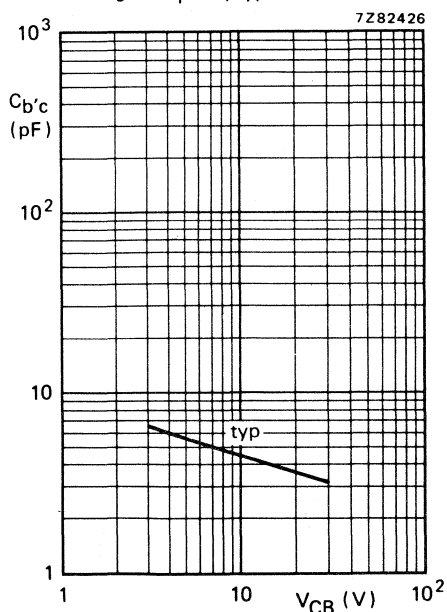

Fig. 12 $f = 1\text{ MHz}$; $T_{amb} = 25^\circ\text{C}$.

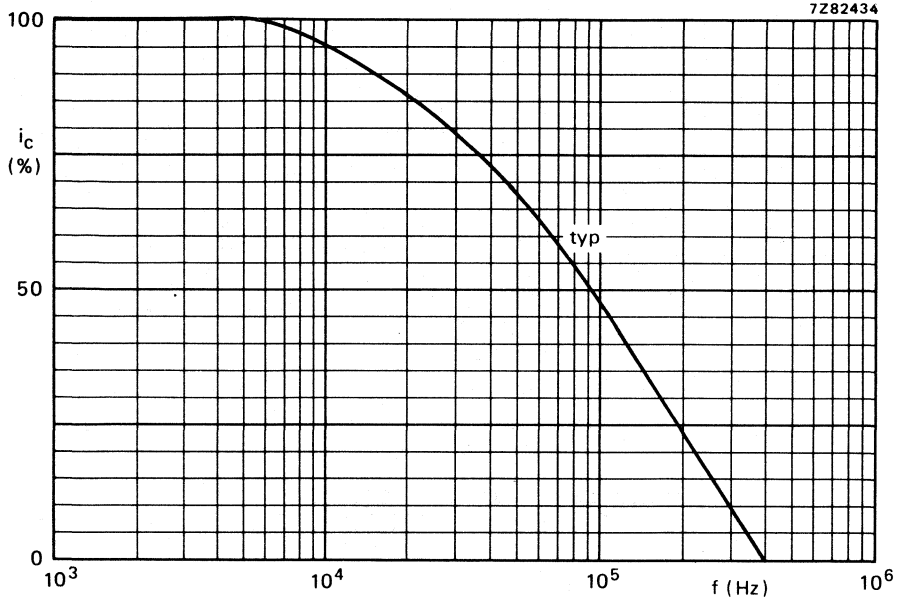

Fig. 13 $I_B = 0$; $I_C = 2 \text{ mA}$; $V_{CC} = 5 \text{ V}$; $R_L = 1 \text{ k}\Omega$; $T_{\text{amb}} = 25 \text{ }^\circ\text{C}$.

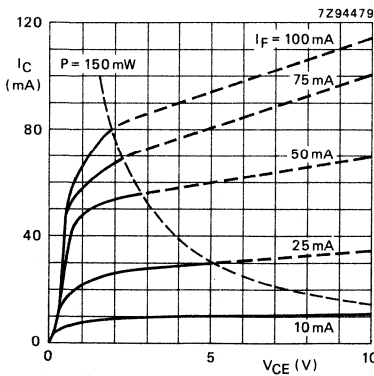

Fig. 14 $T_{\text{amb}} = 25 \text{ }^\circ\text{C}$; typical values.

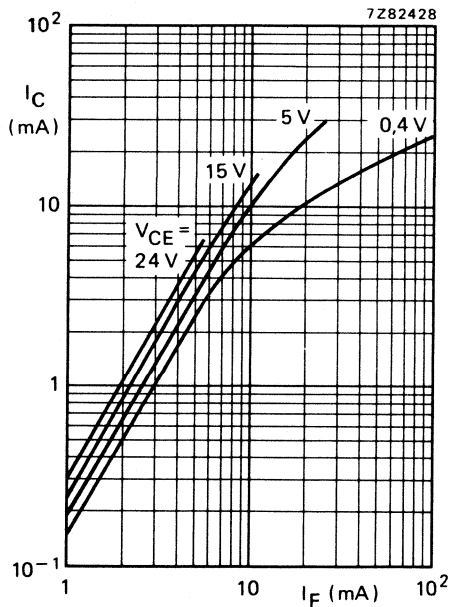

Fig. 15 $T_{\text{amb}} = 25 \text{ }^\circ\text{C}$; typical values.

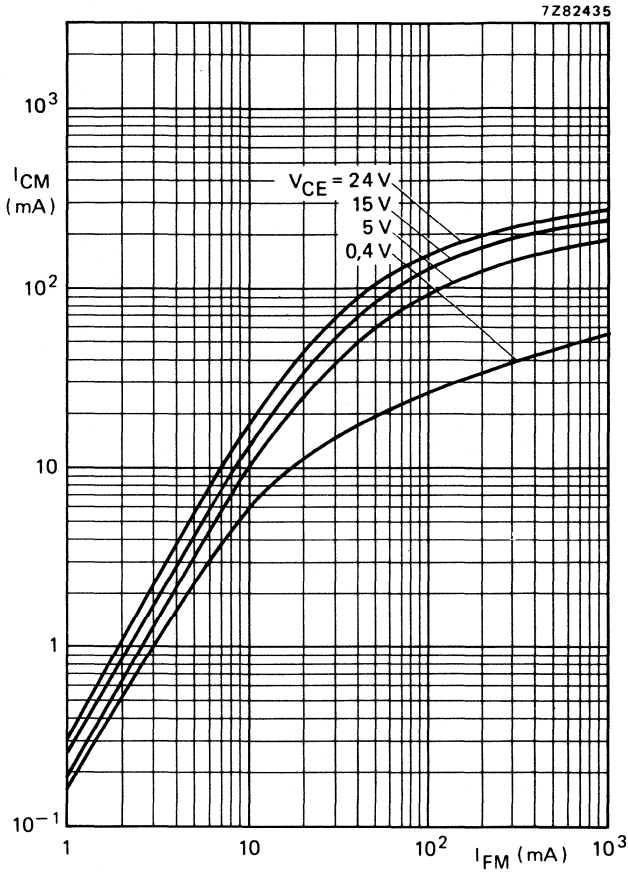

Fig. 16 $T_{amb} = 25$ °C; $t_p = 10$ μ s; $\delta = 0,01$; typical values.

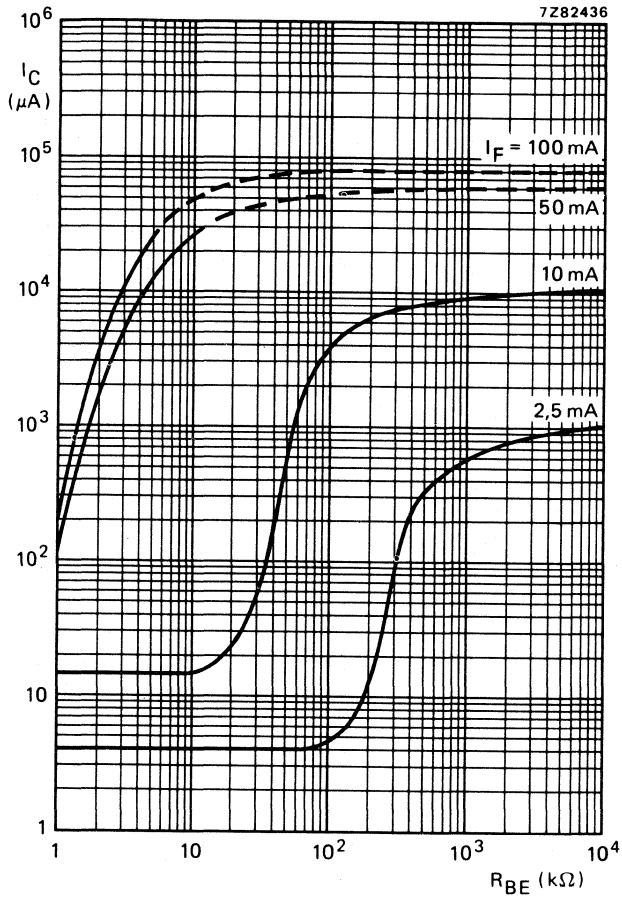

Fig. 17 $I_B = 0$; $V_{CE} = 5 \text{ V}$; $T_{\text{amb}} = 25 \text{ }^\circ\text{C}$; typical values.

7Z82429

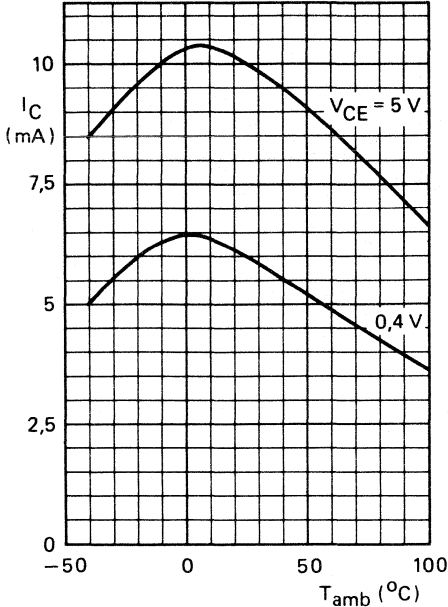

Fig. 18 $I_B = 0$; $I_F = 10$ mA; typical values.

7Z82430

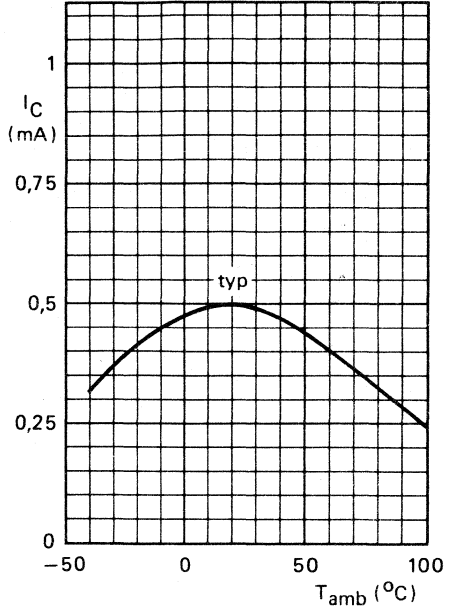

Fig. 19 $I_B = 0$; $I_F = 2$ mA; $V_{CE} = 0.4$ V.

7Z82437

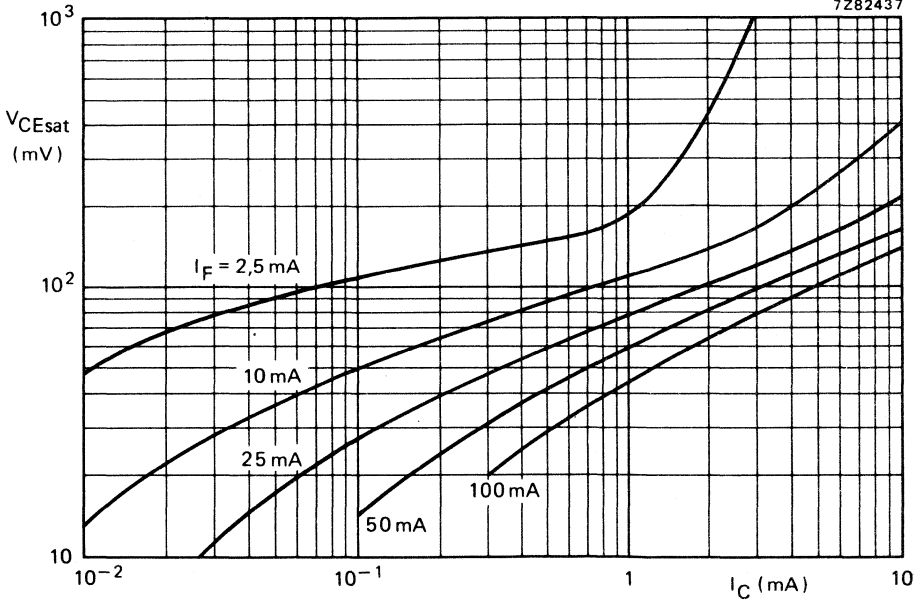

Fig. 20 $I_B = 0$; $T_{amb} = 25^{\circ}C$; typical values.

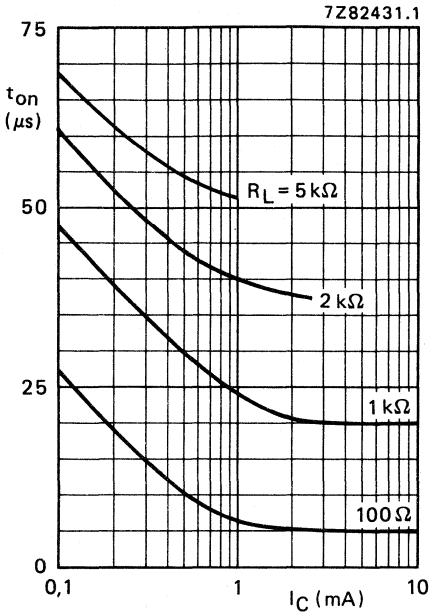

Fig. 21 $I_B = 0$; $V_{CC} = 5 V$; $T_{amb} = 25^\circ C$; typical values. (See Fig. 23).

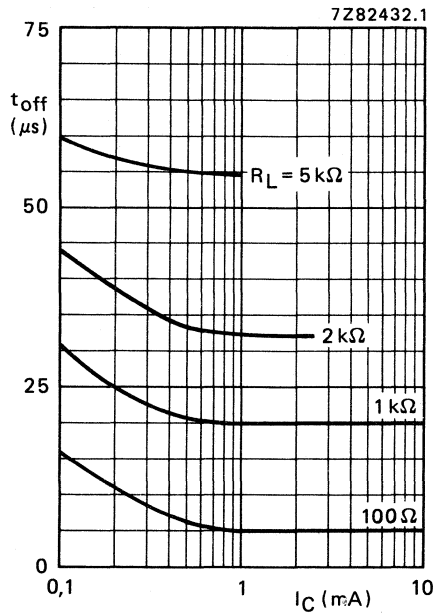
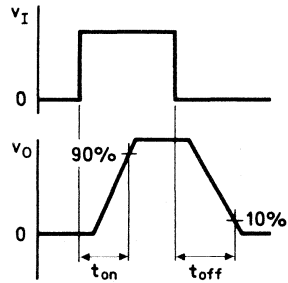
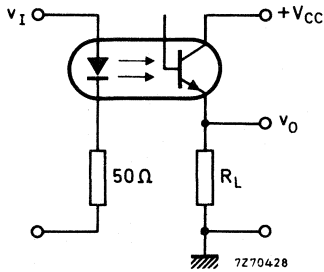

Fig. 22 $I_B = 0$; $V_{CC} = 5 V$; $T_{amb} = 25^\circ C$; typical values. (See Fig. 23).



7267238.1

Fig. 23 Switching circuit and waveforms.

SECTION B2

Photosensitive semiconductors

SILICON PHOTOTRANSISTOR

N-P-N silicon phototransistor in epoxy resin encapsulation intended for optical coupling and encoding. The base is inaccessible. Combination with IR emitter diode CQY58A is recommended.

QUICK REFERENCE DATA

Collector-emitter voltage	V_{CE0}	max.	50 V
Collector current (d.c.)	I_C	max.	25 mA
Total power dissipation up to $T_{amb} = 25\text{ }^\circ\text{C}$	P_{tot}	max.	100 mW
Collector dark current $V_{CE} = 30\text{ V}; E = 0$	$I_{CE0(D)}$	<	100 nA
Collector light current $V_{CE} = 5\text{ V}; E_e = 1\text{ mW/cm}^2; \lambda_p = 930\text{ nm}$	BPW22A-1 BPW22A-2	$I_{CE0(L)}$ $I_{CE0(L)}$	> 1,5 to 8 mA > 5 to 25 mA
Wavelength at peak response	λ_p	typ.	800 nm

MECHANICAL DATA

Dimensions in mm

Fig. 1 SOD-53F.

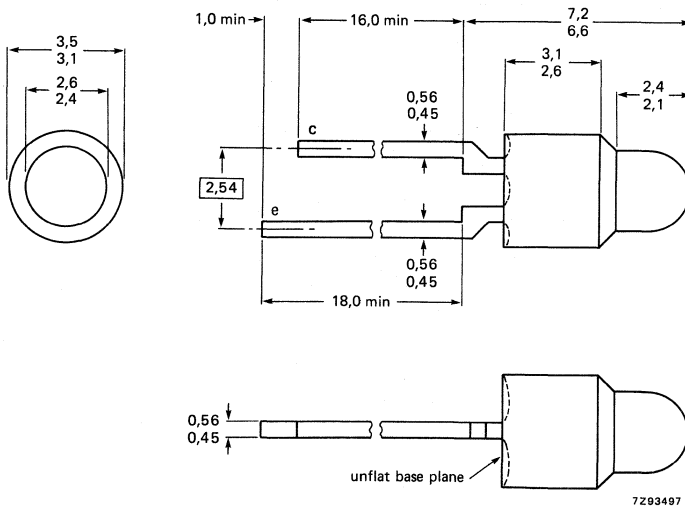

RATINGS

Limiting values in accordance with the Absolute Maximum System (IEC 134)

Collector-emitter voltage	V_{CE0}	max.	50 V
Emitter-collector voltage	V_{ECO}	max.	7 V
Collector current			
d.c.	I_C	max.	25 mA
peak value	I_{CM}	max.	50 mA
Total power dissipation up to $T_{amb} = 25\text{ }^\circ\text{C}$	P_{tot}	max.	100 mW
Storage temperature	T_{stg}		-55 to +100 $^\circ\text{C}$
Junction temperature	T_j	max.	100 $^\circ\text{C}$
Lead soldering temperature			
> 1,5 mm from the seating plane; $t_{sld} < 7\text{ s}$	T_{sld}	max.	260 $^\circ\text{C}$

THERMAL RESISTANCE

From junction to ambient,
device mounted on printed-circuit board

$R_{th\ j-a} = 750\text{ K/W}$

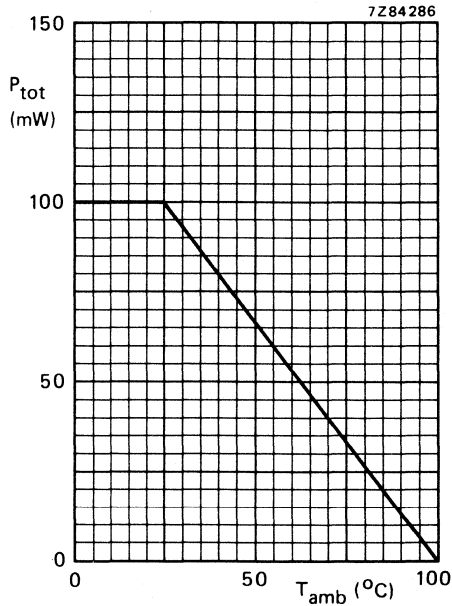

Fig. 2 Power derating curve versus ambient temperature.

CHARACTERISTICS

$T_j = 25\text{ }^\circ\text{C}$ unless otherwise specified

Collector dark current

$V_{CE} = 30\text{ V}; E = 0$

$I_{CEO(D)} < 100\text{ nA}$

Collector light current

$V_{CE} = 5\text{ V}; E_e = 1\text{ mW/cm}^2; \lambda_p = 930\text{ nm}$

BPW22A-1
BPW22A-2

$I_{CEO(L)}$ 1,5 to 8 mA
 $I_{CEO(L)}$ 5 to 25 mA

Collector-emitter saturation voltage

$I_C = 1\text{ mA}; E_e = 1\text{ mW/cm}^2; \lambda_p = 930\text{ nm}$

$V_{CEsat} < 0,4\text{ V}$

Wavelength at peak response

λ_p typ. 800 nm

Bandwidth at half height

$\Delta\lambda$ typ. 400 nm

Half sensitivity angle

$\theta_{1/2}$ typ. 20°

Switching times (see Figs 3, 4, 9 and 10)

$I_{Con} = 2\text{ mA}; V_{CC} = 5\text{ V}; R_E = 100\text{ }\Omega; T_{amb} = 25\text{ }^\circ\text{C}$

turn-on time

t_{on} typ. 3 μs

turn-off time

t_{off} typ. 3 μs

$I_{Con} = 2\text{ mA}; V_{CC} = 5\text{ V}; R_E = 1\text{ k}\Omega; T_{amb} = 25\text{ }^\circ\text{C}$

turn-on time

t_{on} typ. 12,0 μs

turn-off time

t_{off} typ. 12,0 μs

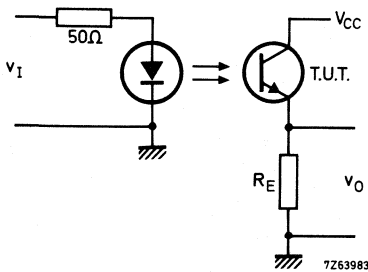

Fig. 3 Switching circuit with light emitting diode CQY58A. T.U.T. = BPW22A.

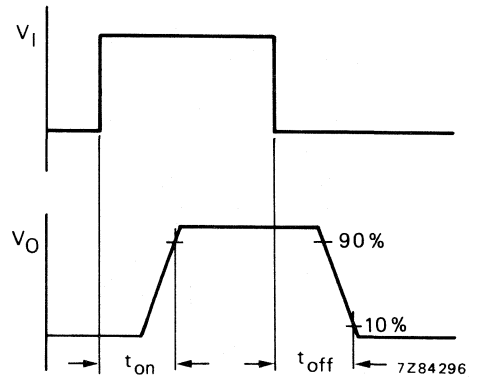

Fig. 4 Input and output switching waveforms.

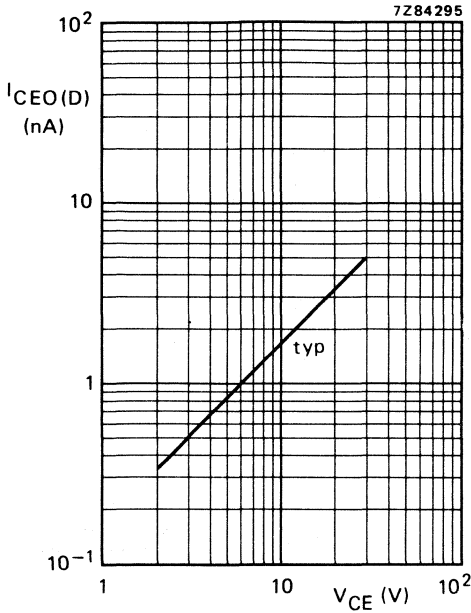

Fig. 5 $E = 0$; $T_j = 25^\circ\text{C}$.

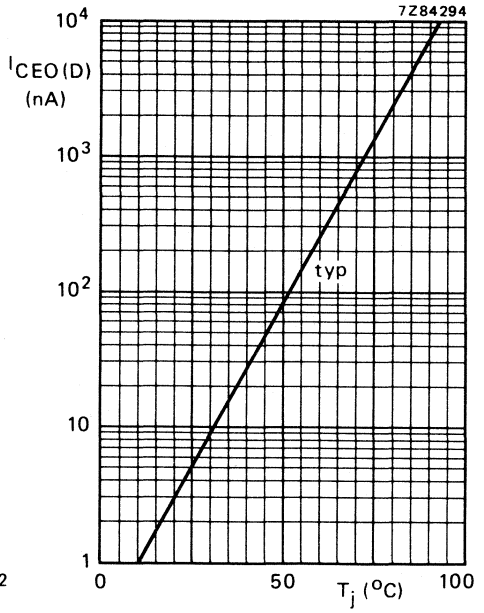

Fig. 6 $E = 0$; $V_{CE} = 30\text{ V}$.

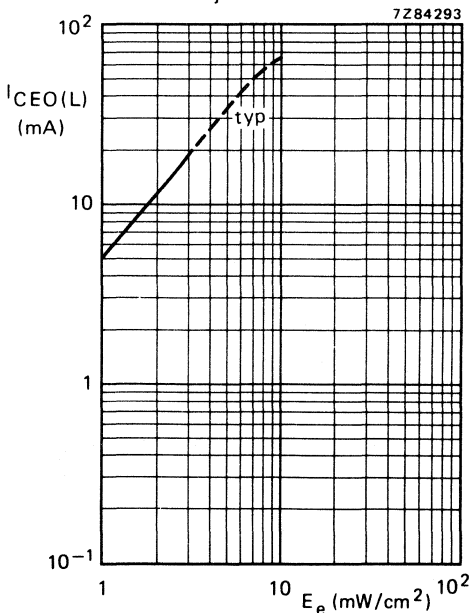

Fig. 7 GaAs source; $\lambda_{pk} = 930\text{ nm}$;
 $V_{CE} = 5\text{ V}$; $T_j = 25^\circ\text{C}$.

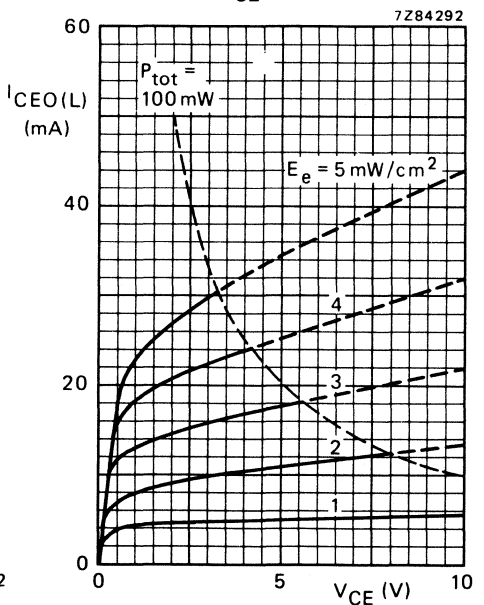

Fig. 8 $\lambda_{pk} = 930\text{ nm}$; $T_j = 25^\circ\text{C}$;
typical values.

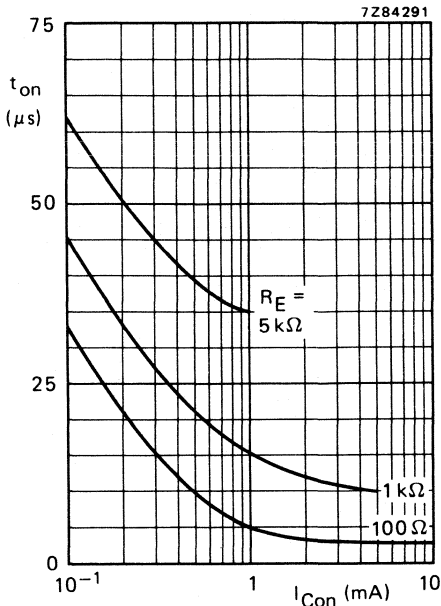

Fig. 9 $V_{CC} = 5 V$; $T_{amb} = 25^\circ C$; typical values; see also Figs 3 and 4.

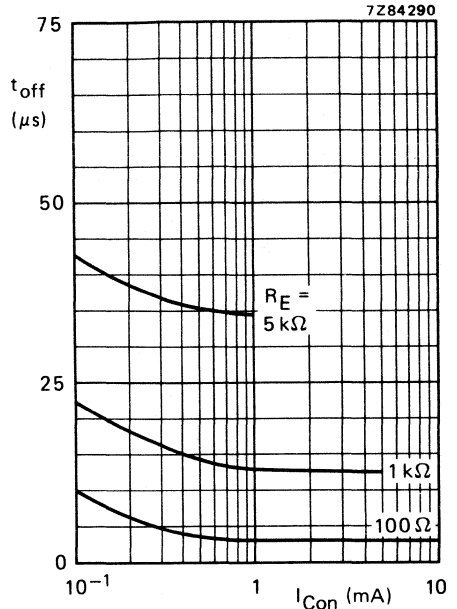

Fig. 10 $V_{CC} = 5 V$; $T_{amb} = 25^\circ C$; typical values; see also Figs 3 and 4.

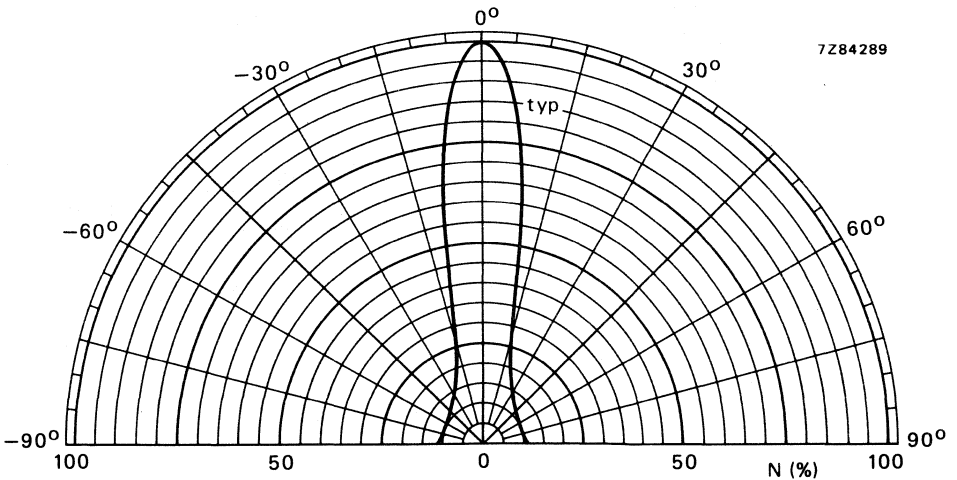

Fig. 11.

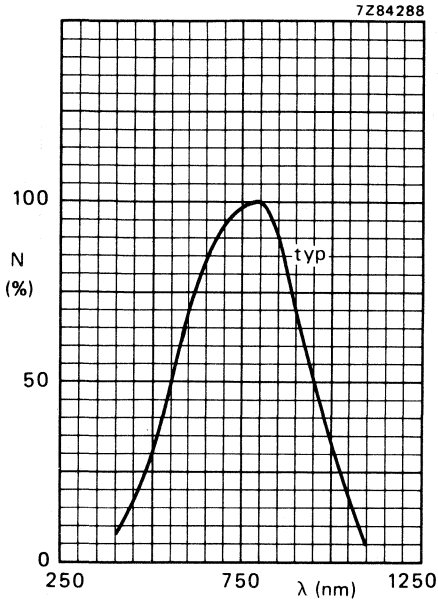

Fig. 12 Spectral response.

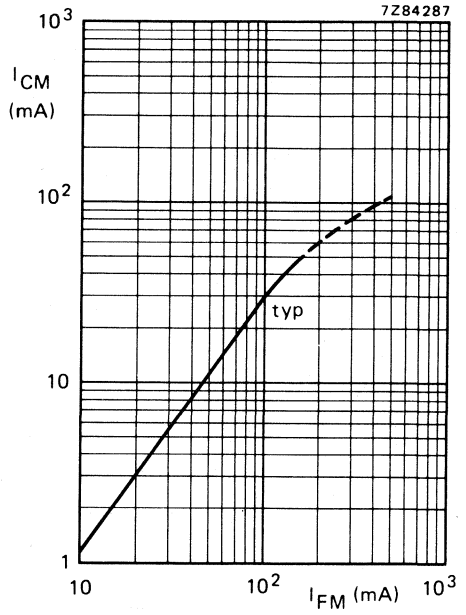

Fig. 13 $V_{CE} = 5$ V; $t_p(I_{FM}) = 10 \mu s$; $T = 1$ ms; $d^* = 10$ mm; $T_{amb} = 25$ °C.

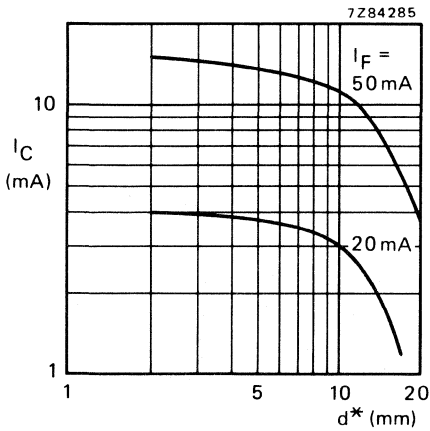

Fig. 14 $V_{CE} = 5$ V; $T_{amb} = 25$ °C; typical values.

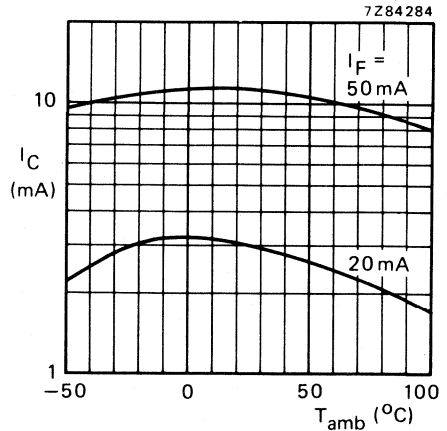

Fig. 15 $V_{CE} = 5$ V; $d^* = 10$ mm; typical values.

* d = shortest free distance of mechanical on-axis when BPW22A is coupled with CQY58A.

HIGH-SPEED SILICON PHOTO P-I-N DIODE

The BPW50 is optimized for applications with remote control systems. Combination with IR emitter diode CQY89A-2 or CQW89A is recommended. If combined with high-speed IR emitting diode CQW89A, carrier frequencies of up to 1 MHz can be applied.

QUICK REFERENCE DATA

Continuous reverse voltage	V_R	max.	32 V
Total power dissipation up to $T_{amb} = 47,5\text{ }^\circ\text{C}$	P_{tot}	max.	150 mW
Junction temperature	T_j	max.	100 $^\circ\text{C}$
Dark reverse current $V_R = 10\text{ V}; E_e = 0$	$I_{R(D)}$	<	30 nA
Light reverse current $V_R = 5\text{ V}; E_e = 1\text{ mW/cm}^2; \lambda = 930\text{ nm}$	$I_{R(L)}$	>	30 μA
Wavelength at peak response $V_R = 5\text{ V}$	λ_p	typ.	930 nm
Sensitive area	A	typ.	5 mm ²

MECHANICAL DATA

Dimensions in mm

Fig. 1 SOD-67.

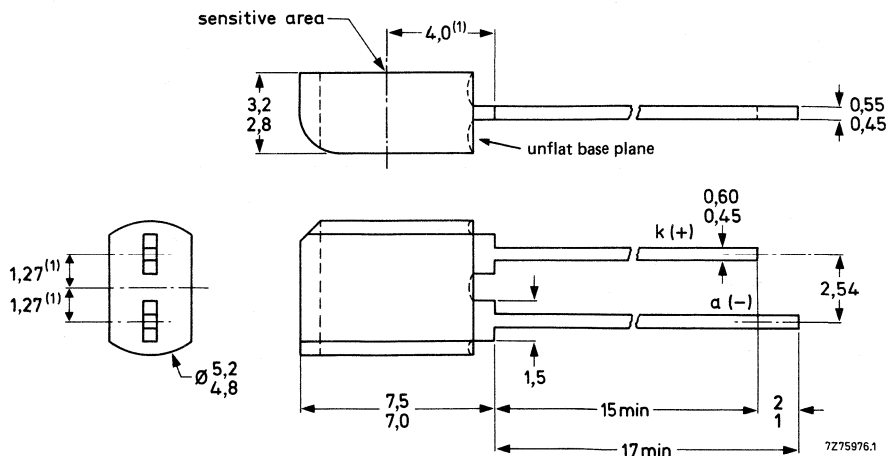

(1) Reference for the positional tolerance of the sensitive area.

RATINGS

Limiting values in accordance with the Absolute Maximum System (IEC 134)

Continuous reverse voltage	V_R	max.	32 V
Total power dissipation up to $T_{amb} = 47,5\text{ }^\circ\text{C}$	P_{tot}	max.	150 mW
Storage temperature	T_{stg}		-30 to $+100\text{ }^\circ\text{C}$
Junction temperature	T_j	max.	100 $^\circ\text{C}$
Lead soldering temperature up to the seating plane; $t_{sld} < 10\text{ s}$	T_{sld}	max.	260 $^\circ\text{C}$

THERMAL RESISTANCE

→ From junction to ambient in free air $R_{th\ j-a} = 350\text{ K/W}$

CHARACTERISTICS

$T_j = 25\text{ }^\circ\text{C}$

Dark reverse current
 $V_R = 10\text{ V}; E_e = 0$

$I_{R(D)}$ typ. 2 nA
< 30 nA

Light reverse current
 $V_R = 5\text{ V}; E_e = 1\text{ mW/cm}^2; \lambda = 930\text{ nm}$

$I_{R(L)}$ > 30 μA
typ. 45 μA

Reverse voltage
 $I_R = 0,1\text{ mA}; E_e = 0$

$V_R > 32\text{ V}$

→ Wavelength at peak response
 $V_R = 5\text{ V}$

λ_p typ. 930 nm

Diode capacitance
 $V_R = 3\text{ V}$

C_d typ. 17 pF
< 30 pF

$V_R = 0$

C_d typ. 50 pF

Light switching times (see Figs 2 and 3)
Rise time and fall time
 $V_{KK} = 10\text{ V}; R_A = 1\text{ k}\Omega$

t_r, t_f typ. 50 ns

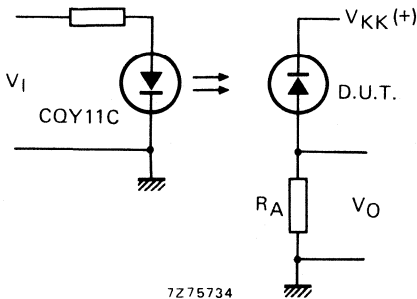

Fig. 2 Switching circuit.

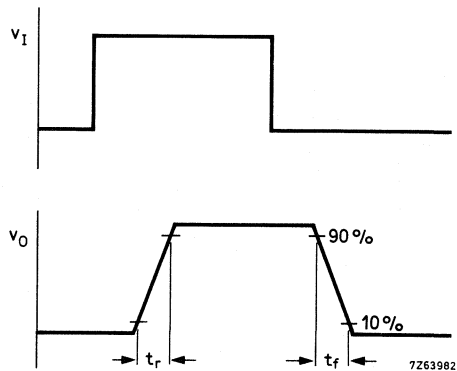

Fig. 3 Input and output switching waveforms.

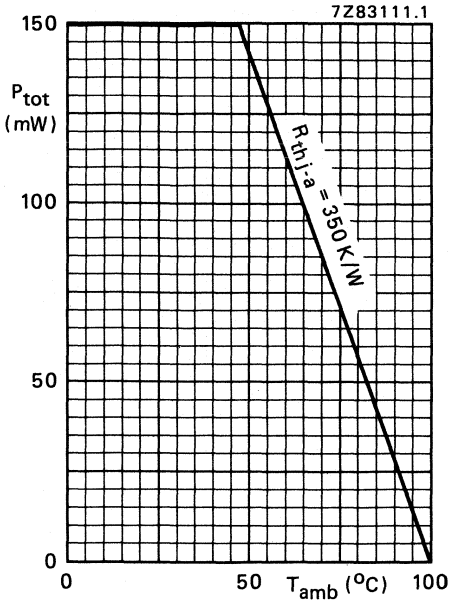

Fig. 4 Maximum permissible power dissipation as a function of temperature.

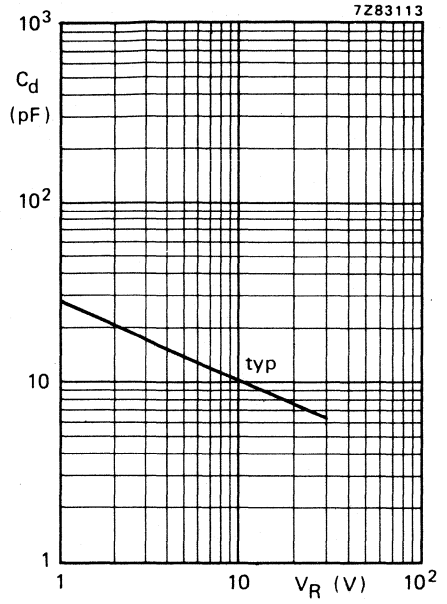

Fig. 5 $T_{amb} = 25 \text{ }^{\circ}\text{C}$.

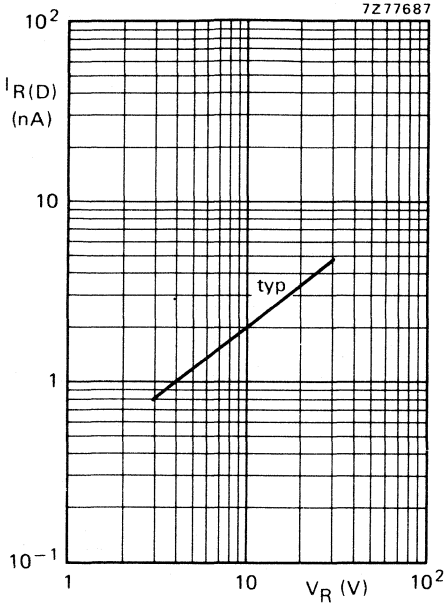

Fig. 6 $E = 0$; $T_{amb} = 25^\circ\text{C}$.

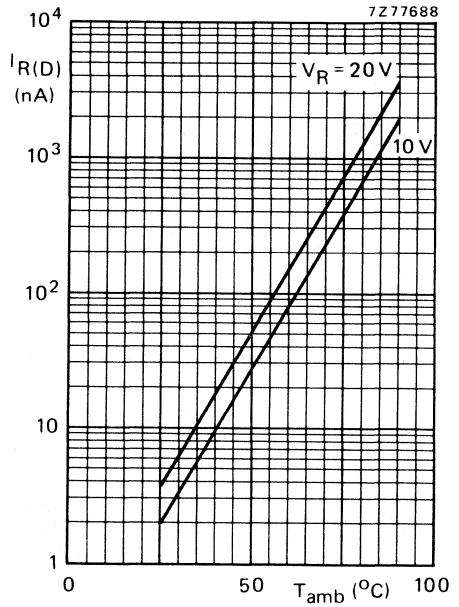

Fig. 7 $E = 0$; typical values.

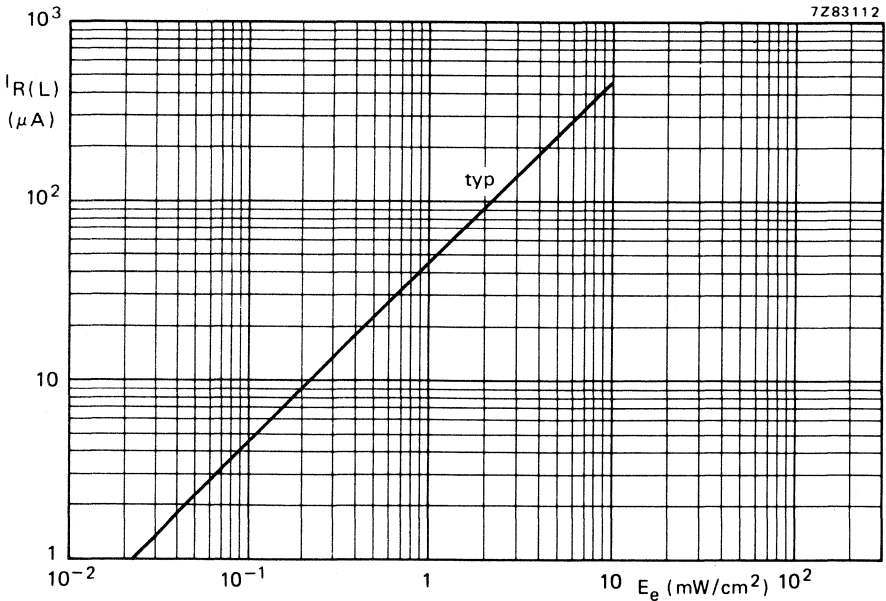

Fig. 8 $V_R = 5\text{ V}$; $\lambda = 930\text{ nm}$; $T_{amb} = 25^\circ\text{C}$.

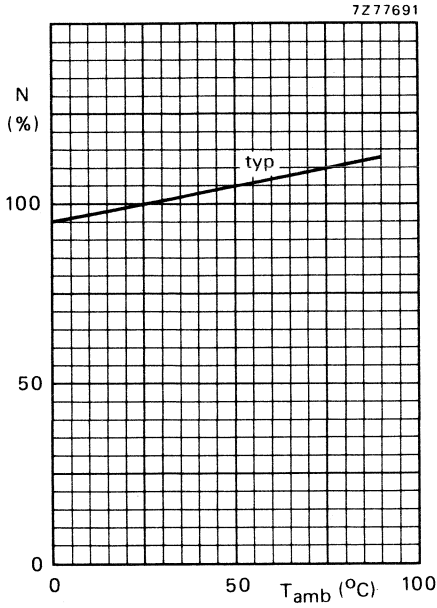

Fig. 9 $E_e = 1 \text{ mW/cm}^2$; $\lambda = 930 \text{ nm}$.

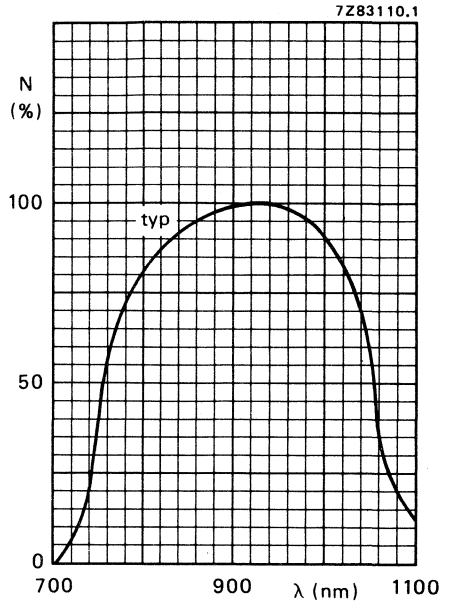

Fig. 10 $V_R = 5 \text{ V}$; $T_{amb} = 25 \text{ }^\circ\text{C}$.

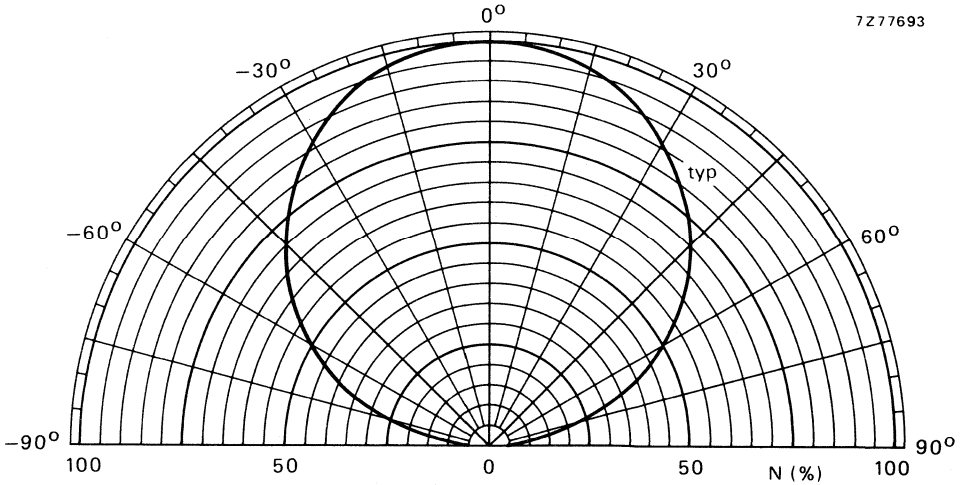

Fig. 11.

SILICON PHOTO-DARLINGTON TRANSISTOR

N-P-N subminiature photo-darlington transistor mounted in a SOT-71 envelope.

This envelope is designed for assembly onto printed circuit boards.

QUICK REFERENCE DATA

Collector-emitter voltage	V_{CE0}	max.	30 V
Collector current (peak value)	I_{CM}	max.	150 mA
Junction temperature	T_j	max.	150 °C
Collector dark current $V_{CE} = 10 \text{ V}; E = 0$	I_{CEO}	max.	100 nA
Collector current $V_{CE} = 5 \text{ V}; E = 1 \text{ mW/cm}^2$ (see note 1)	I_C	min.	15 mA
Wavelength of maximum sensitivity $E = 1 \text{ mW/cm}^2$	λ	typ.	800 nm

MECHANICAL DATA

Dimensions in mm

SOT-71A (see Fig. 1).

MECHANICAL DATA

Fig. 1 SOT-71A.

Dimensions in mm

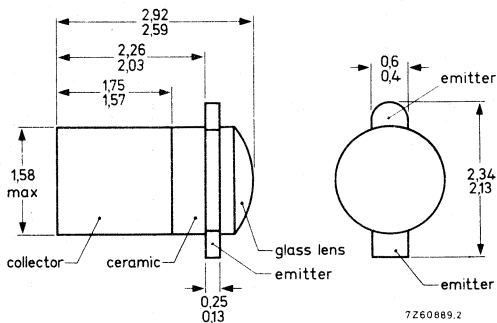

RATINGS

Limiting values in accordance with the Absolute Maximum System (IEC 134)

Collector-emitter voltage	V_{CEO}	max.	30 V
Emitter-collector voltage	V_{ECO}	max.	7 V
Collector current (d.c.)	I_C	max.	100 mA
Collector current (peak value) $t_p = 100 \mu s; \delta = 0,1$	I_{CM}	max.	150 mA
Total power dissipation up to $T_{amb} = 55 \text{ }^\circ\text{C}$ when mounted on a printed circuit board	P_{tot}	max.	100 mW
Storage temperature	T_{stg}		-65 to +150 $^\circ\text{C}$
Junction temperature	T_j	max.	150 $^\circ\text{C}$
Lead soldering temperature; < 10 s	T_{slid}	max.	240 $^\circ\text{C}$

THERMAL RESISTANCE

Thermal resistance from junction to ambient	$R_{th j-a}$	max.	2000 K/W
Thermal resistance from junction to ambient when device is mounted on a P.C.B.	$R_{th j-a}$	max.	950 K/W

CHARACTERISTICS $T_j = 25\text{ }^\circ\text{C}$ unless otherwise stated

Collector-emitter breakdown voltage

 $I_C = 1\text{ mA}$ $V_{(BR)CEO}$ min. 30 V

Emitter-collector breakdown voltage

 $I_C = 0,1\text{ mA}$ $V_{(BR)ECO}$ min. 7 V

Collector dark current

 $V_{CE} = 10\text{ V}; E = 0$ I_{CEO} typ. 25 nA
max. 100 nA $V_{CE} = 10\text{ V}; E = 0; T_j = 100\text{ }^\circ\text{C}$ I_{CEO} typ. 200 μA

Collector current

 $V_{CE} = 5\text{ V}; E = 1\text{ mW/cm}^2$

(see note 1)

 I_C min. 15 mA
typ. 37 mA

Collector-emitter saturation voltage

 $I_C = 2\text{ mA}; E = 1\text{ mW/cm}^2$

(see note 1)

 V_{CEsat} max. 1,1 V

Switching times (see Fig. 2 and 3)

 $I_C = 5\text{ mA}; V_{CC} = 5\text{ V}; R_L = 100\ \Omega$

Delay time

 t_d typ. 25 μs

Rise time

 t_r typ. 60 μs
max. 300 μs

Storage time

 t_s typ. 2,0 μs

Fall time

 t_f typ. 40 μs
max. 200 μs

Wavelength of maximum sensitivity

 $E = 1\text{ mW/cm}^2$ λ typ. 800 nm

Bandwidth of half sensitivity

 $E = 1\text{ mW/cm}^2$ $\Delta\lambda$ typ. 400 nm

Halve sensitivity angle

 $\theta_{1/2}$ typ. 20 $^\circ$

Sensitive area

A typ. 1,7 mm^2

Note 1: For this measurement, the source is a GaAs diode (930 nm).

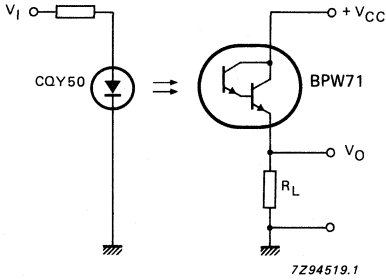

Fig. 2 Measuring circuit.

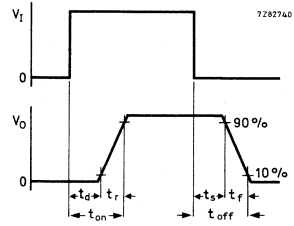

Fig. 3 Waveforms.

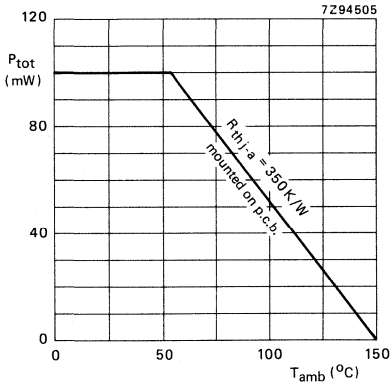

Fig. 4 Power derating curve.

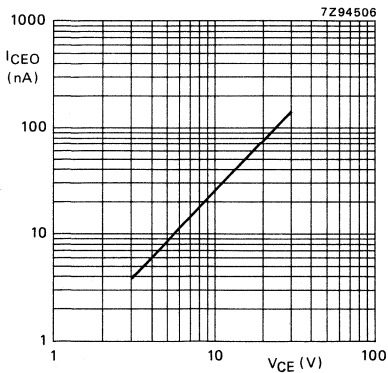

Fig. 5 $T_j = 25 \text{ }^\circ\text{C}$; typical values.

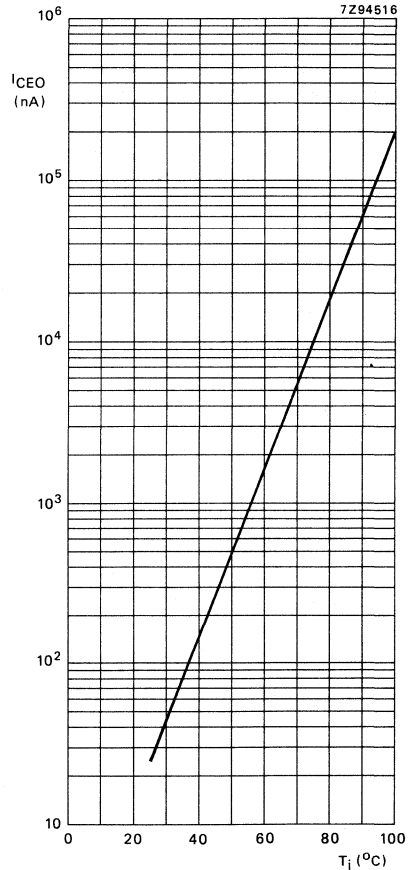

Fig. 6 $V_{CE} = 10 \text{ V}$; typical values.

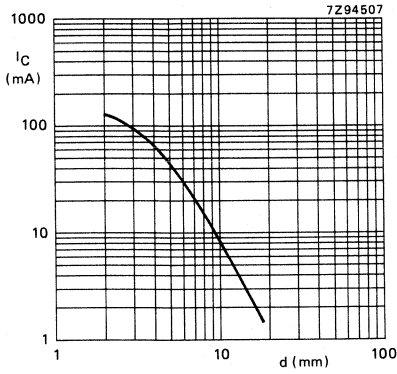

Fig. 7 $V_{CE} = 5$ V; $I_F = 20$ mA;
 $T_{amb} = 25$ °C; typical values.

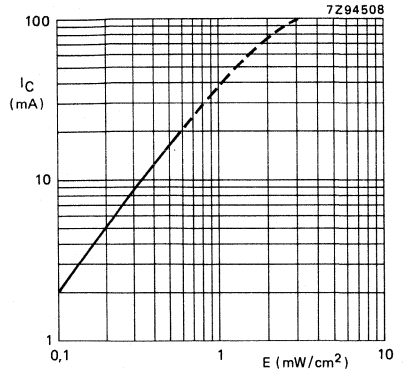

Fig. 8 $V_{CE} = 5$ V; source $\lambda = 930$ nm;
typical values.

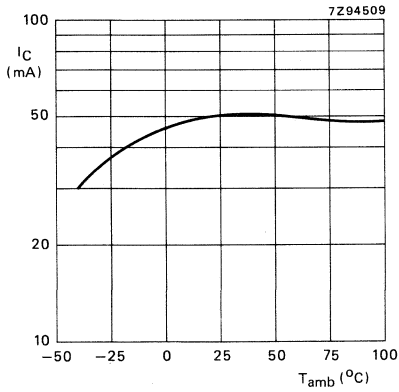

Fig. 9 $V_{CE} = 5$ V; $I_F = 20$ mA;
typical values.

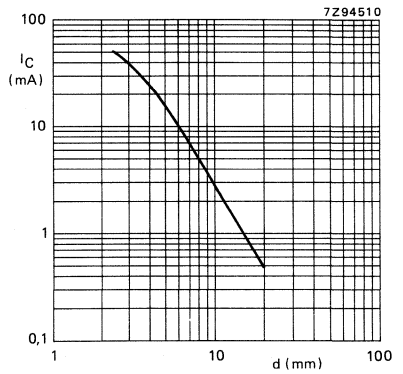
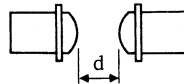

Fig. 10 $V_{CE} = 5$ V; $I_F = 10$ mA;
 $T_{amb} = 25$ °C; $d = 5$ mm; typical values.



(coupled with CQY50)

7Z94517

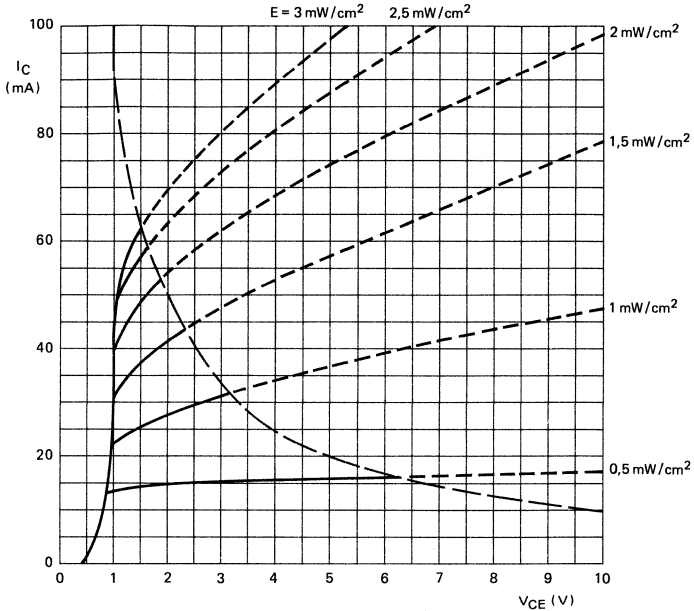

Fig. 11 $T_{amb} = 25\text{ }^\circ\text{C}$; source $\lambda = 930\text{ nm}$; typical values.

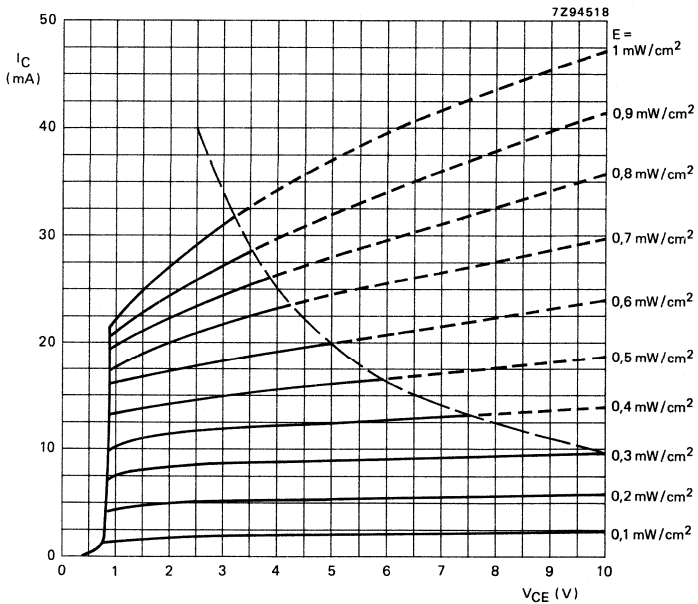

Fig. 12 $T_{amb} = 25\text{ }^\circ\text{C}$; source $\lambda = 930\text{ nm}$; typical values.

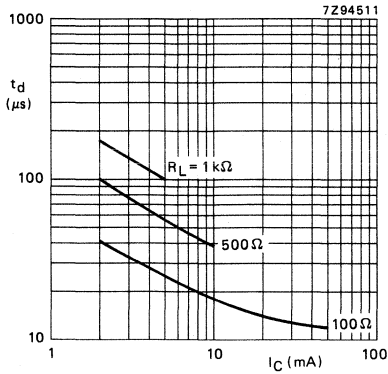

Fig. 13 $T_{\text{amb}} = 25\ \text{°C}$; $V_{\text{CC}} = 5\ \text{V}$; typical values.

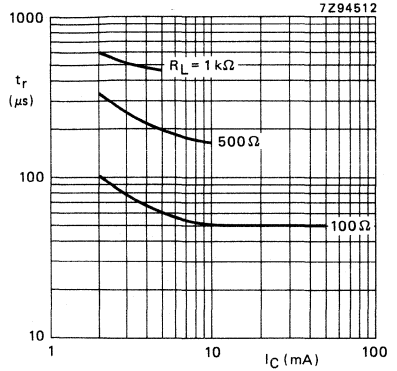

Fig. 14 $T_{\text{amb}} = 25\ \text{°C}$; $V_{\text{CC}} = 5\ \text{V}$; typical values.

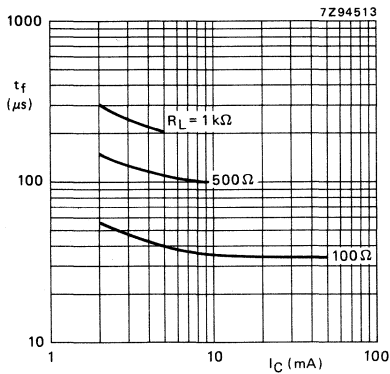

Fig. 15 $T_{\text{amb}} = 25\ \text{°C}$; $V_{\text{CC}} = 5\ \text{V}$; typical values.

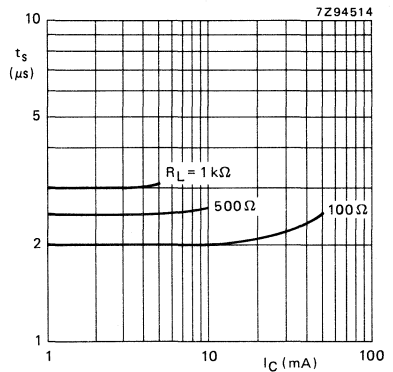

Fig. 16 $T_{\text{amb}} = 25\ \text{°C}$; $V_{\text{CC}} = 5\ \text{V}$; typical values.

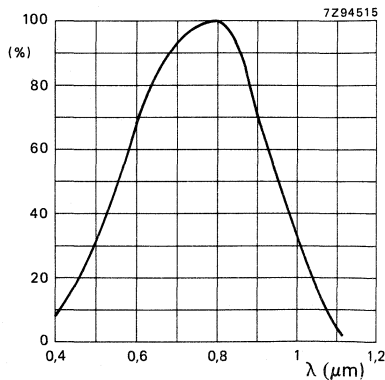

Fig. 17 Typical values.

7Z88892

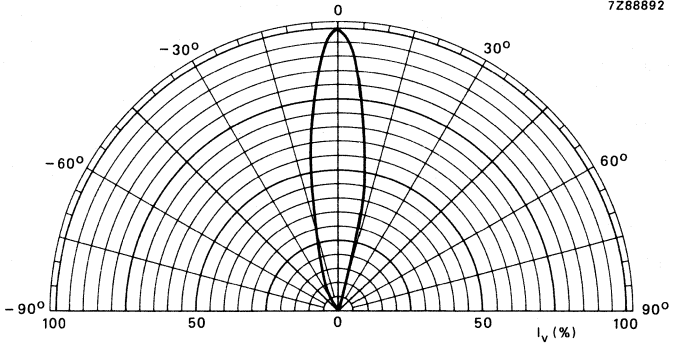

Fig. 18.

SILICON PLANAR EPITAXIAL PHOTOTRANSISTORS

General purpose n-p-n silicon phototransistors in a TO-18 envelope. The BPX25 has a lens, the BPX29 has a plane window. Combination with CQY11B and CQY11C or CQY49B and CQY49C is recommended.

QUICK REFERENCE DATA

Collector-emitter voltage		V_{CE0}	max.	50 V
Collector current (peak value)		I_{CM}	max.	200 mA
Junction temperature		T_j	max.	150 °C
Collector dark current		I_{CEO}	max.	100 nA
$V_{CE} = 24 \text{ V}; E = 0$				
Collector light current		I_C	min.	4 mA
$V_{CE} = 6 \text{ V}; E = 1000 \text{ lux}$	BPX25	I_C	min.	0,2 mA
	BPX29	I_C		

MECHANICAL DATA

Dimensions in mm

See Fig. 1.

BPX25 BPX29

MECHANICAL DATA

Dimensions in mm

Fig. 1a SOT-29/2.

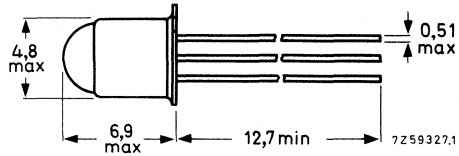
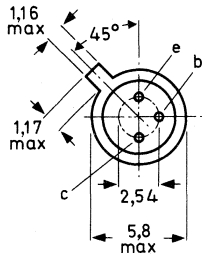

BPX25

Fig. 1b SOT-29/1.

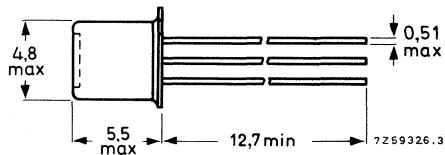
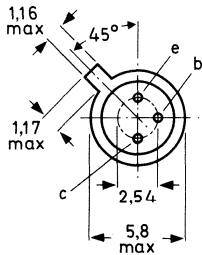

BPX29

RATINGS

Limiting values in accordance with the Absolute Maximum System (IEC 134)

Collector-base voltage	V_{CB0}	max.	50 V
Collector-emitter voltage	V_{CE0}	max.	50 V
Emitter-base voltage	V_{EB0}	max.	7 V
Collector current (d.c.)	I_C	max.	100 mA
Collector current (peak value) ; $t_p = 50 \mu s$; $\delta = 0,1$	I_{CRM}	max.	200 mA
Total power dissipation up to $T_{amb} = 25 \text{ }^\circ\text{C}$	P_{tot}	max.	300 mW
Storage temperature	T_{stg}		-65 to +150 $^\circ\text{C}$
Junction temperature	T_j	max.	150 $^\circ\text{C}$

THERMAL RESISTANCE

Thermal resistance from junction to ambient	$R_{th j-a}$	max.	400 K/W
Thermal resistance from junction to case	$R_{th j-c}$	max.	150 K/W

CHARACTERISTICS $T_j = 25\text{ }^\circ\text{C}$ unless otherwise stated

Collector dark current

 $V_{CE} = 24\text{ V}; E = 0$

I_{CEO}	typ.	10 nA
	max.	100 nA

 $V_{CE} = 24\text{ V}; E = 0; T_j = 100\text{ }^\circ\text{C}$

I_{CEO}	typ.	10 μA
	max.	100 μA

D.C. current gain

 $I_C = 2\text{ mA}; V_{CE} = 6\text{ V}$

h_{FE}	typ.	500
----------	------	-----

Cut-off frequency

Source : modulated GaAs : 0,4 mW/cm²Load : optimum (50 Ω); $V_{CE} = 24\text{ V}$

f_{CO}	typ.	200 kHz
----------	------	---------

Collector light current

 $V_{CE} = 6\text{ V}$ $E = 1000\text{ lux}$ (see note 1)

		BPX25	BPX29
I_C	min.	4,0	0,2 mA
	typ.	10	0,6 mA

Switching times (see note 2)

Delay time

t_d	typ.	1,0	2,5 μs
	max.	3,0	5,0 μs

Rise time

t_r	typ.	1,5	2,5 μs
	max.	3,0	5,0 μs

Storage time

t_s	typ.	0,2	0,2 μs
	max.	0,5	0,5 μs

Fall time

t_f	typ.	1,5	3,5 μs
	max.	4,0	8,0 μs

Half sensitivity angle

$\theta_{1/2}$	typ.	30	80 $^\circ$
----------------	------	----	-------------

Wavelength at peak response

λ_p	typ.	800	800 nm
-------------	------	-----	--------

Bandwidth at half height

$\Delta\lambda$	typ.	400	400 nm
-----------------	------	-----	--------

Note 1: Source : tungsten filament lamp with $T_c = 2856\text{ K}$ Note 2: Source : modulated GaAs: 0,4 mW/cm²load : optimum (50 Ω); $V_{CE} = 24\text{ V}$

BPX25
BPX29

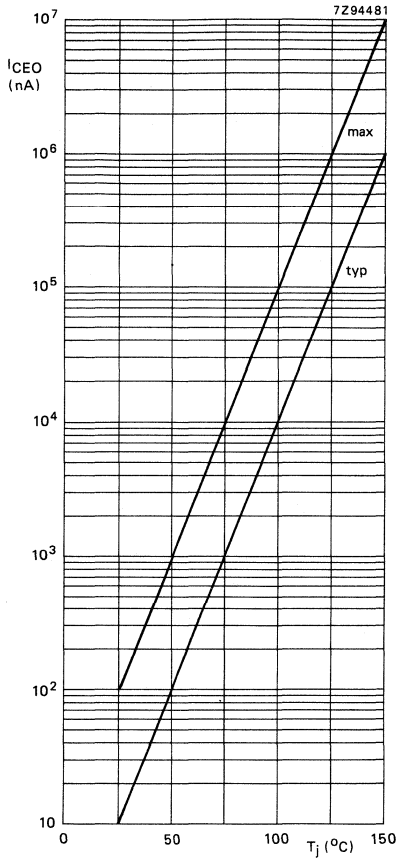

Fig. 2 Typical values; $E = 0$; $V_{CE} = 24$ V.

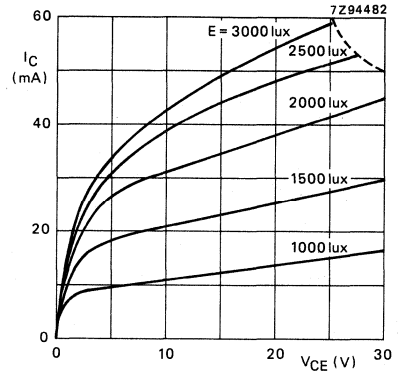

Fig. 3 BPX25; Typical values.

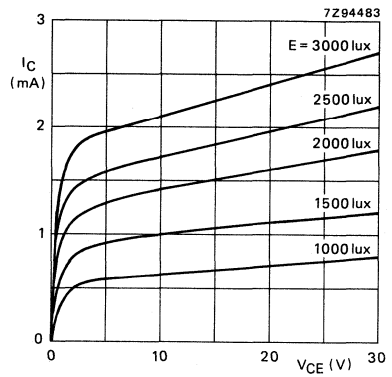

Fig. 4 BPX29; Typical values.

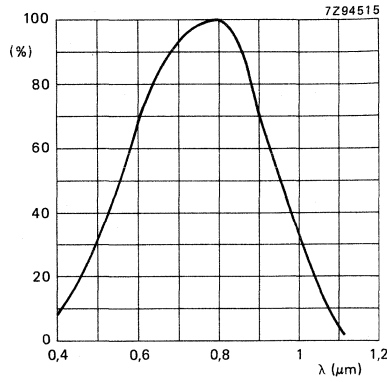

Fig. 5 Typical values.

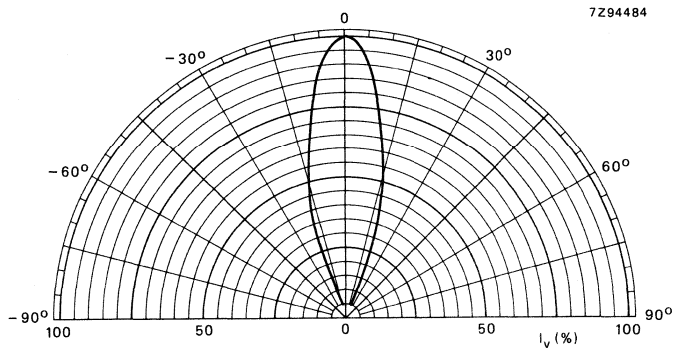

Fig. 6 BPX25; Typical values.

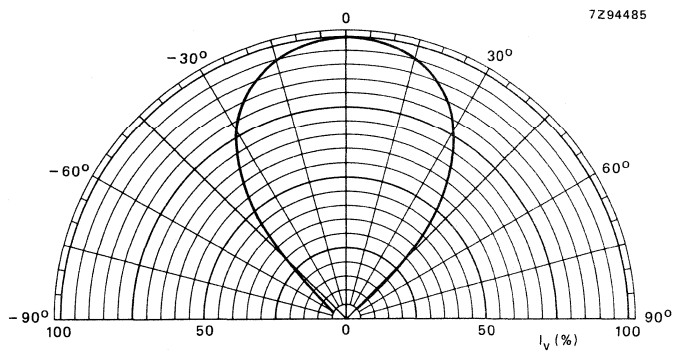

Fig. 7 BPX29; Typical values.

SILICON PLANAR PHOTODIODE

Unencapsulated photodiode for general purpose applications.

QUICK REFERENCE DATA

Reverse voltage	V_R max.	18 V
Luminous current $V_R = 15$ V; $E = 1000$ lx	I_{PO} typ.	14 μ A
Dark reverse current at $V_R = 15$ V	I_R <	0,5 μ A
Wavelength at peak response	λ_p typ.	800 nm

MECHANICAL DATA

Dimensions in mm

Fig. 1.

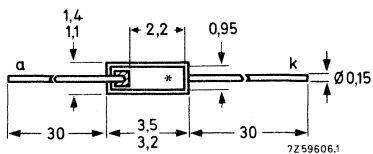

Slice thickness 0,27 mm

* Sensitive area = 2,2 x 0,95 mm.

RATINGS

Limiting values in accordance with the Absolute Maximum System (IEC 134)

Reverse voltage	V_R	max.	18 V
Forward current	I_F	max.	5 mA
Dark reverse current	I_R	max.	2 mA
Storage temperature	T_{stg}		-65 to +125 °C
Junction temperature	T_j	max.	125 °C

THERMAL RESISTANCE

From junction to ambient in free air	$R_{th\ j-a}$	=	0,5 K/mW
--------------------------------------	---------------	---	----------

CHARACTERISTICS

$T_{amb} = 25\text{ °C}$ unless otherwise specified

Dark reverse current

$V_R = 15\text{ V}$	I_R	typ.	0,01 μA
		<	0,5 μA

$V_R = 15\text{ V}; T_{amb} = 100\text{ °C}$	I_R	typ.	0,6 μA
		<	4,0 μA

Photovoltaic mode

$E = 1000\text{ lx}; T_c = 2856\text{ K}$ (equivalent to 4,75 mW/cm²)

Light reverse current; $V = 0$

	I_l	>	8 μA
		typ.	13 μA

Forward voltage; $I = 0$

	V_F	>	330 mV
		typ.	350 mV

Luminous current with external voltage*

$V_R = 15\text{ V}; E = 1000\text{ lx}; T_c = 2856\text{ K}$
(equivalent to 4,75 mW/cm²)

	I_{Po}	>	8,5 μA
		typ.	14 μA

Wavelength at peak response

	λ_p	typ.	800 nm
--	-------------	------	--------

Diode capacitance; $f = 500\text{ kHz}$

$V_R = 15\text{ V}$	C_d	typ.	90 pF
---------------------	-------	------	-------

$V_R = 0$	C_d	typ.	300 pF
-----------	-------	------	--------

Cut-off frequency (modulated GaAs source)

	f_{co}	typ.	500 kHz
--	----------	------	---------

* The value of light current increases with temperature by an amount approximately equal to the increase in dark current.

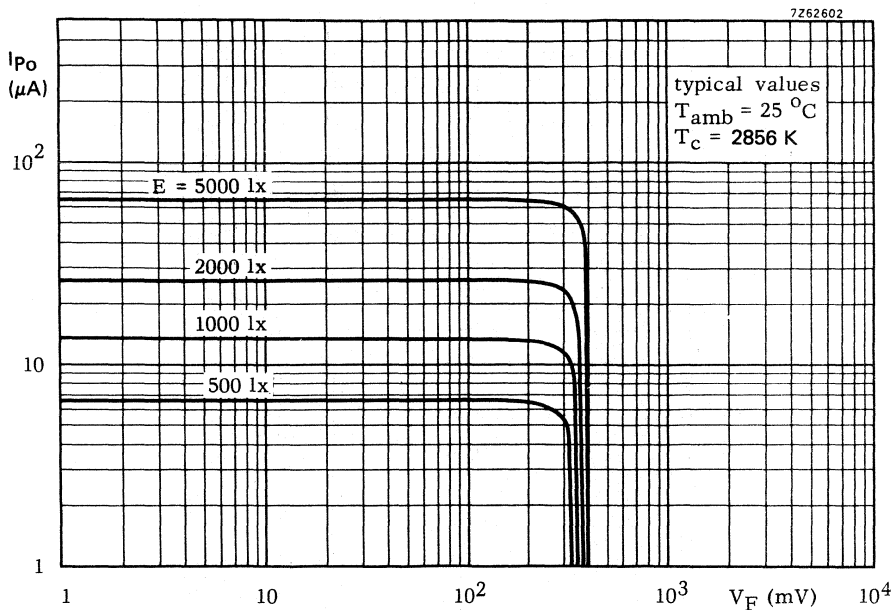

Fig. 2.

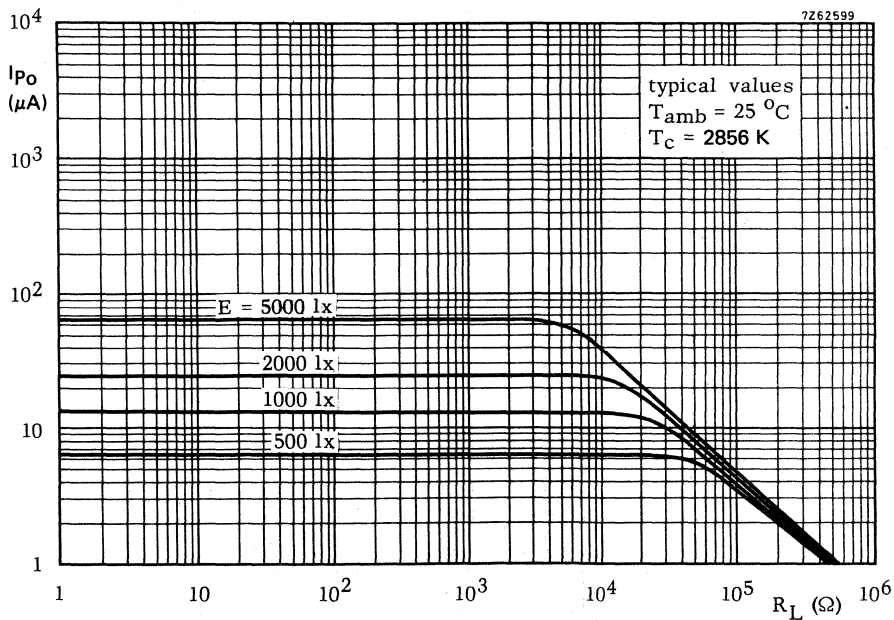

Fig. 3.

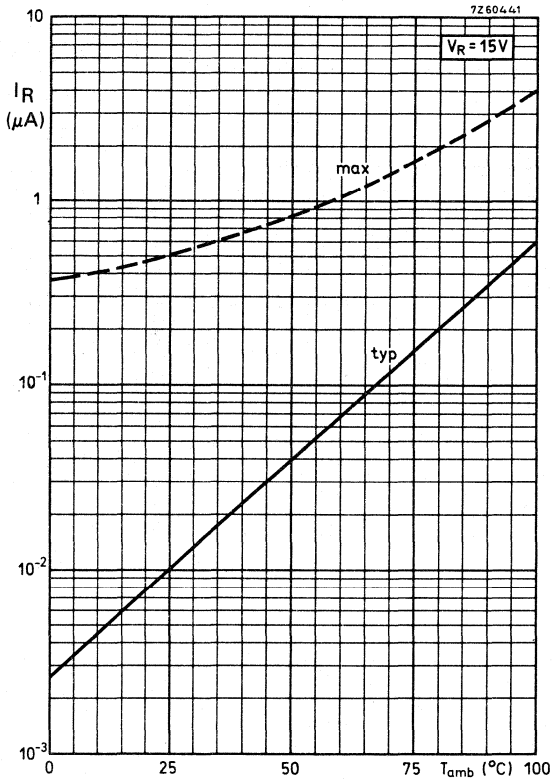

Fig. 4.

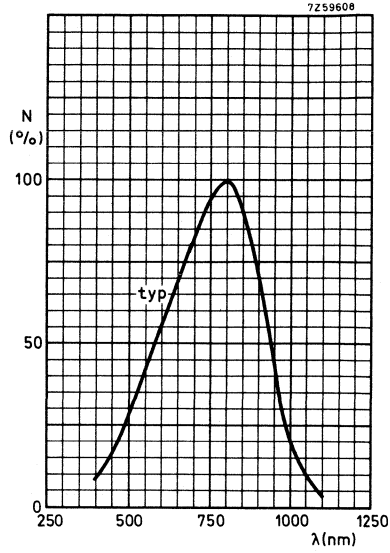

Fig. 5.

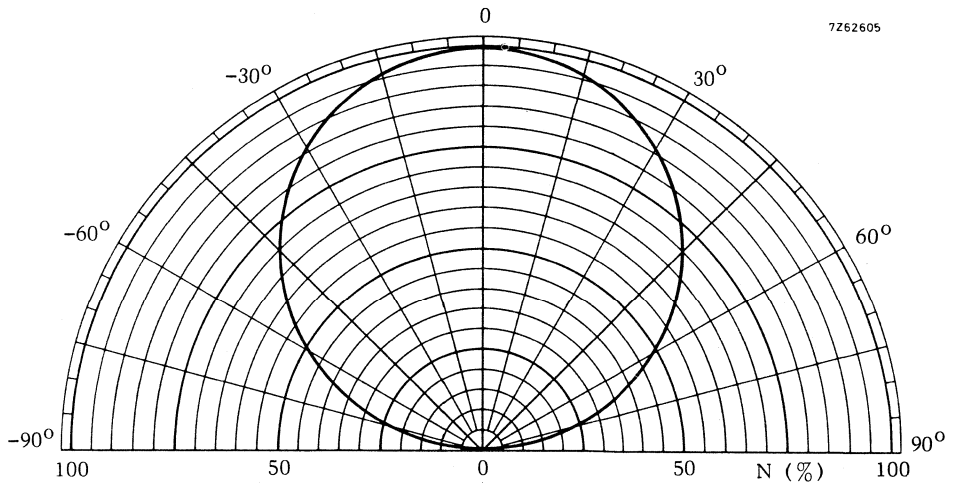

Fig. 6.

SILICON PLANAR PHOTODIODE

Unencapsulated photodiode for general purpose applications.

QUICK REFERENCE DATA

Reverse voltage	V_R max.	18 V
Luminous current $V_R = 15$ V; $E = 1000$ lx	I_{p0} typ.	40 μ A
Dark reverse current at $V_R = 15$ V	I_R <	1 μ A
Wavelength at peak response	λ_p typ.	800 nm

MECHANICAL DATA

Dimensions in mm

Fig. 1.

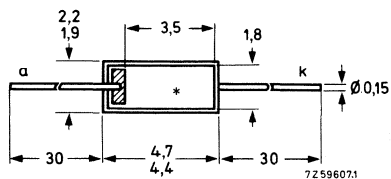

Slice thickness 0,27 mm

* Sensitive area = 3,5 x 1,8 mm.

RATINGS

Limiting values in accordance with the Absolute Maximum System (IEC 134)

Reverse voltage	V_R	max.	18 V
Forward current	I_F	max.	10 mA
Dark reverse current	I_R	max.	5 mA
Storage temperature	T_{stg}		-65 to + 125 °C
Junction temperature	T_j	max.	125 °C

THERMAL RESISTANCE

From junction to ambient in free air	$R_{th\ j-a}$	=	0,5 K/mW
--------------------------------------	---------------	---	----------

CHARACTERISTICS

$T_{amb} = 25\text{ °C}$ unless otherwise specified

Dark reverse current $V_R = 15\text{ V}$	I_R	typ.	0,02 μA
		<	1,0 μA

$V_R = 15\text{ V}; T_{amb} = 100\text{ °C}$	I_R	typ.	1,2 μA
		<	8,0 μA

Photovoltaic mode

$E = 1000\text{ lx}; T_C = 2856\text{ K}$ (equivalent to 4,75 mW/cm ²)		>	24 μA
Light reverse current; $V = 0$	I_l	typ.	38 μA

Forward voltage; $I = 0$	V_F	>	330 mV
		typ.	350 mV

Luminous current with external voltage*

$V_R = 15\text{ V}; E = 1000\text{ lx}; T_C = 2856\text{ K}$ (equivalent to 4,75 mW/cm ²)	I_{Po}	>	25 μA
		typ.	40 μA

Wavelength at peak response	λ_p	typ.	800 nm
-----------------------------	-------------	------	--------

Diode capacitance; $f = 500\text{ kHz}$ $V_R = 15\text{ V}$	C_d	typ.	250 pF
--	-------	------	--------

$V_R = 0$	C_d	typ.	800 pF
Cut-off frequency (modulated GaAs source)	f_{co}	typ.	500 kHz

* The value of light current increases with temperature by an amount approximately equal to the increase in dark current.

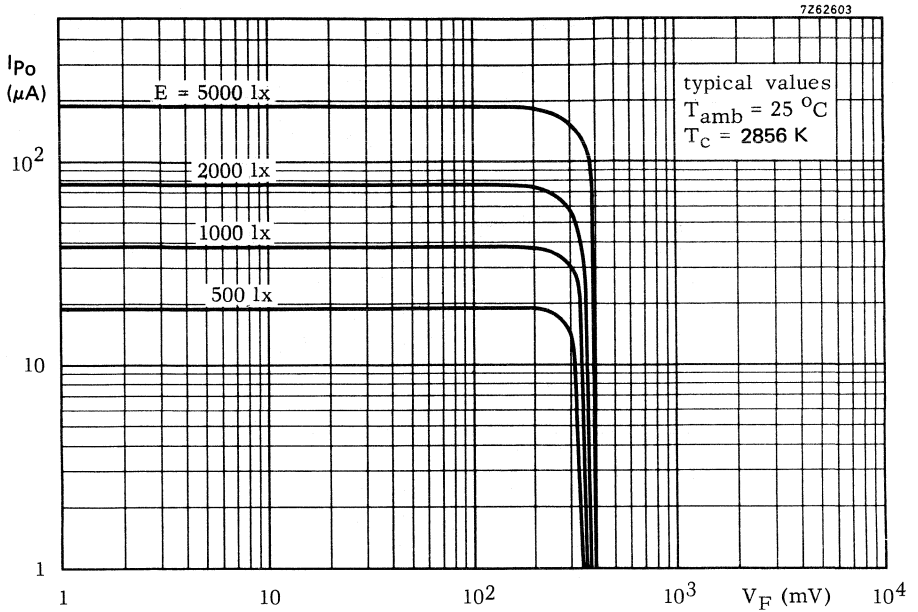

Fig. 2.

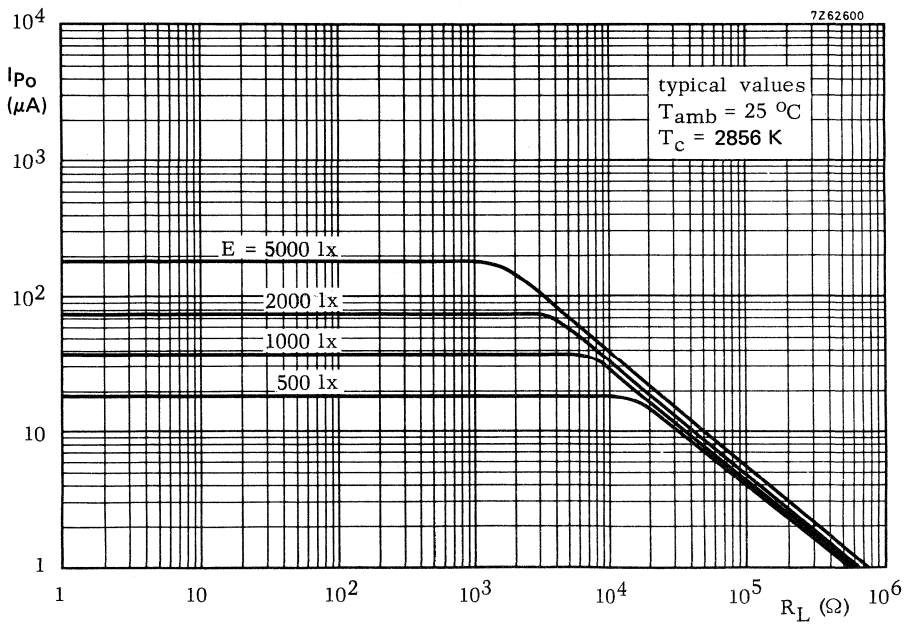

Fig. 3.

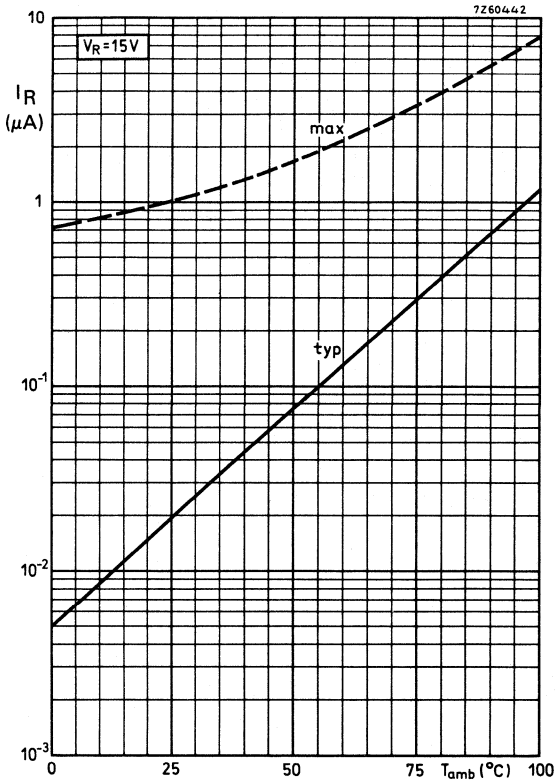

Fig. 4.

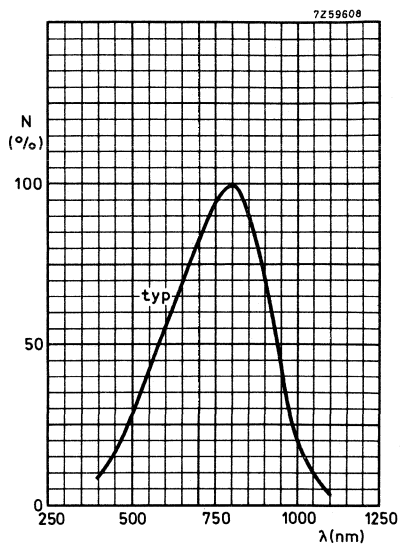

Fig. 5.

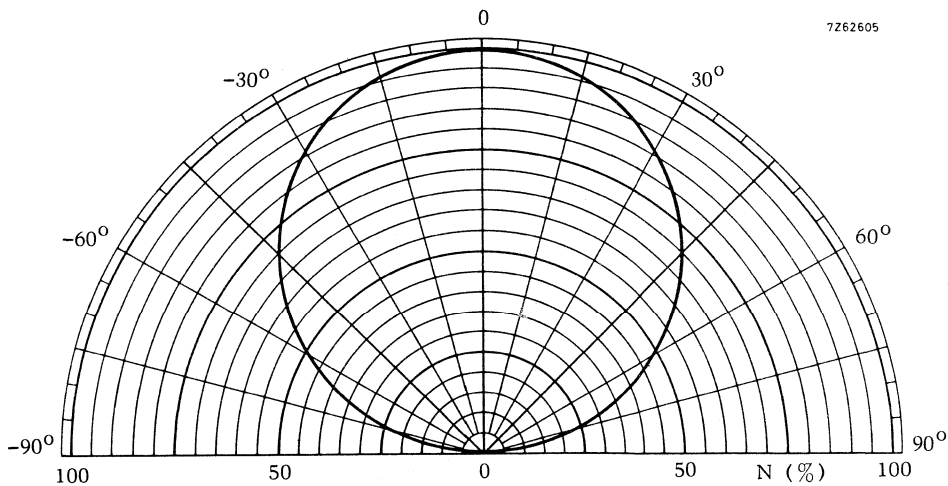

Fig. 6.

SILICON PLANAR PHOTODIODE

Unencapsulated photodiode for general purpose applications.

QUICK REFERENCE DATA

Reverse voltage	V_R	max.	12 V
Luminous current $V_R = 10 \text{ V}; E = 1000 \text{ lx}$	I_{PO}	typ.	110 μA
Dark reverse current at $V_R = 10 \text{ V}$	I_R	<	5 μA
Wavelength at peak response	λ_p	typ.	800 nm

MECHANICAL DATA

Dimensions in mm

Fig. 1.

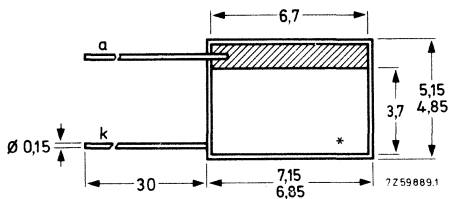

Slice thickness 0,27 mm

* Sensitive area 6,7 x 3,7 mm.

RATINGS

Limiting values in accordance with the Absolute Maximum System (IEC 134)

Reverse voltage	V_R	max.	12 V
Forward current	I_F	max.	50 mA
Dark reverse current	I_R	max.	20 mA
Storage temperature	T_{stg}		-65 to + 125 °C
Junction temperature	T_j	max.	125 °C

THERMAL RESISTANCE

From junction to ambient in free air	$R_{th\ j-a}$	=	0,3 K/mW
--------------------------------------	---------------	---	----------

CHARACTERISTICS

$T_{amb} = 25\text{ °C}$ unless otherwise specified

Dark reverse current $V_R = 10\text{ V}$	I_R	typ. <	0,1 μA 5,0 μA
$V_R = 10\text{ V}; T_{amb} = 100\text{ °C}$	I_R	typ. <	6,0 μA 40 μA

Photovoltaic mode

$E = 1000\text{ lx}; T_c = 2856\text{ K}$ (equivalent to 4,75 mW/cm²)

Light reverse current; $V = 0$	I_1	> typ.	75 μA 140 μA
Forward voltage; $I = 0$	V_F	> typ.	330 mV 350 mV

Luminous current with external voltage*

$V_R = 10\text{ V}; E = 1000\text{ lx}; T_c = 2856\text{ K}$ (equivalent to 4,75 mW/cm ²)	I_{Po}	> typ.	85 μA 110 μA
--	----------	-----------	---------------------------

Wavelength at peak response	λ_p	typ.	800 nm
-----------------------------	-------------	------	--------

Diode capacitance; $f = 500\text{ kHz}$ $V_R = 10\text{ V}$	C_d	typ.	1000 pF
$V_R = 0$	C_d	typ.	3000 pF

Cut-off frequency (modulated GaAs source)	f_{co}	typ.	500 kHz
---	----------	------	---------

* The value of light current increases with temperature by an amount approximately equal to the increase in dark current.

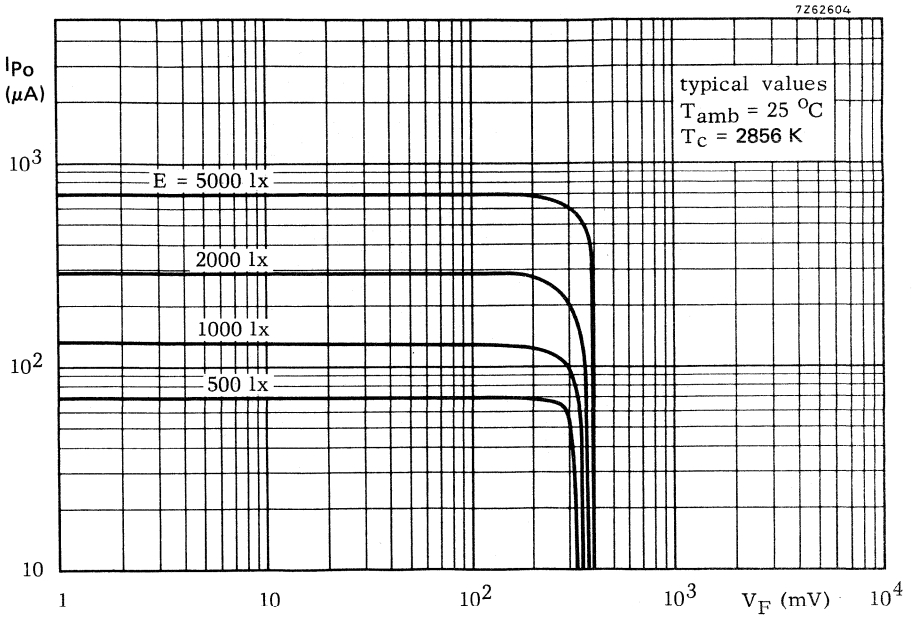

Fig. 2.

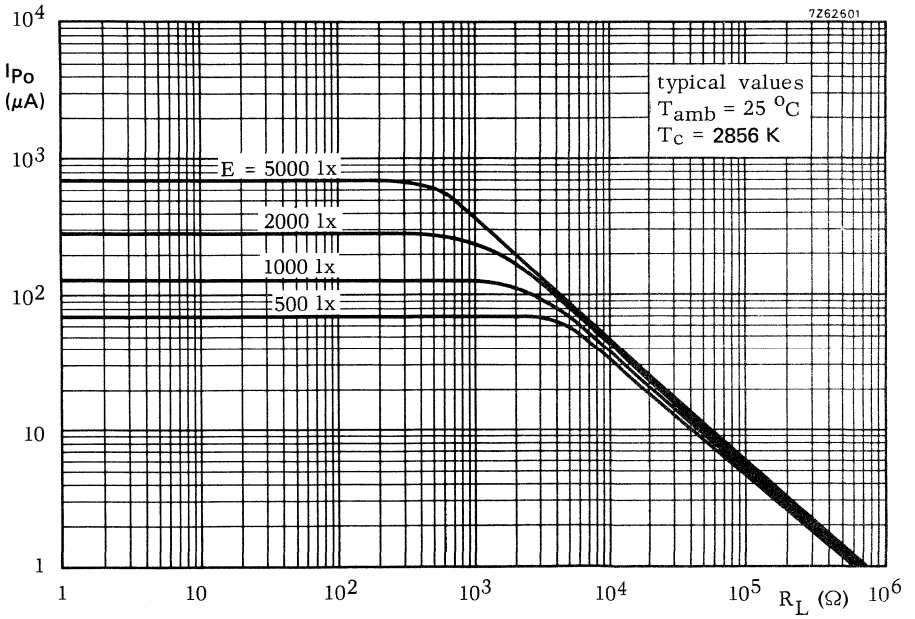

Fig. 3.

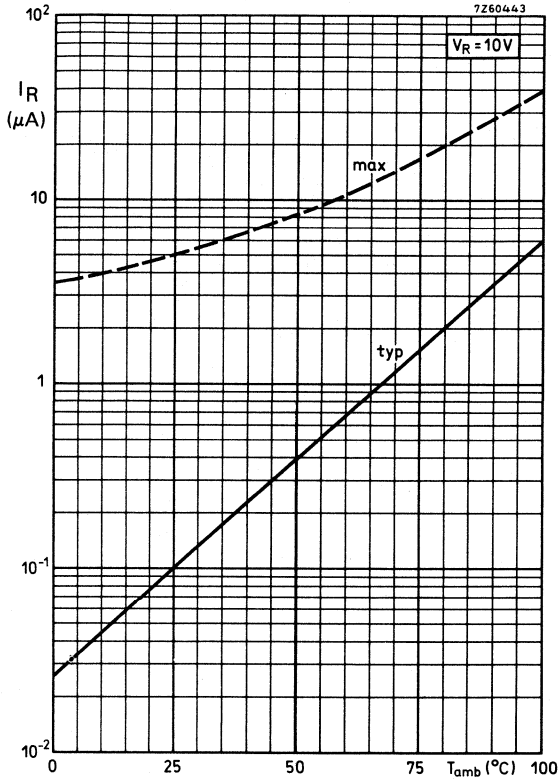

Fig. 4.

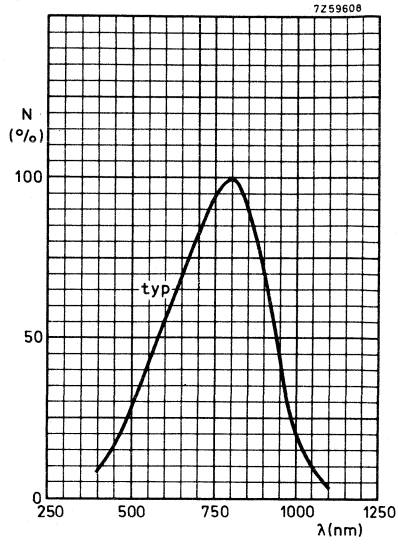

Fig. 5.

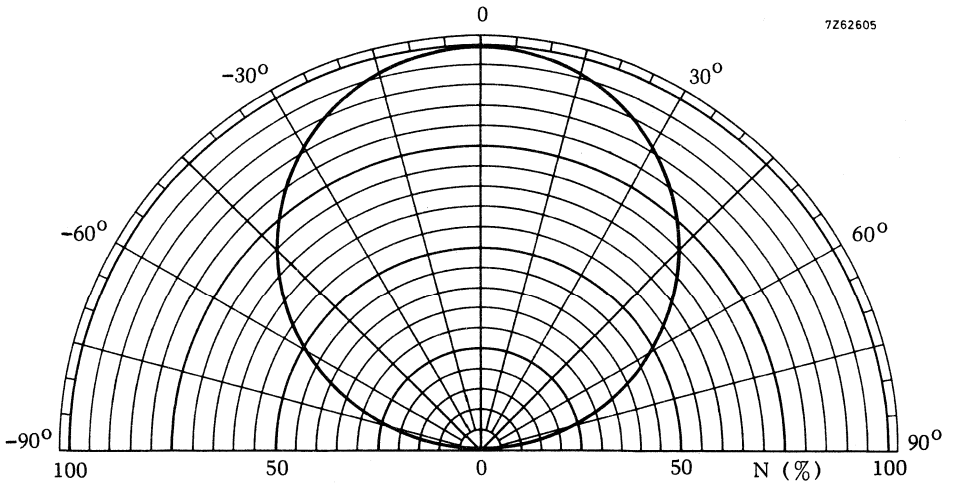

Fig. 6.

SILICON PLANAR PHOTODIODE

PIN silicon planar photodiode mounted in a SOT-49 envelope.

QUICK REFERENCE DATA

Reverse voltage	BPX61 BPX61P	V_R	max. max.	32 V 70 V
Sensitivity $V_R = 5 \text{ V}; E = 1 \text{ mW/cm}^2;$ $\lambda = 930 \text{ nm}$		S_E	min.	35 μA
Sensitive area		A	typ.	6,75 mm^2
Total power dissipation up to $T_{\text{amb}} = 25 \text{ }^\circ\text{C}$		P_{tot}	max.	325 mW

MECHANICAL DATA

Dimensions in mm

Fig. 1 SOT-49/3.

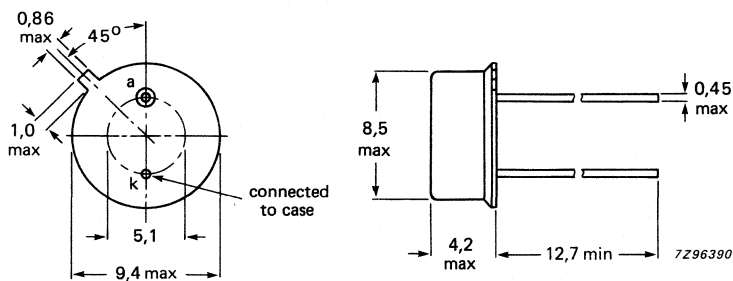

BPX61 BPX61P

RATINGS

Limiting values in accordance with the Absolute Maximum System (IEC 134)

Reverse voltage	BPX61 BPX61P	V_R	max. max.	32 V 70 V *
Total power dissipation up to $T_{amb} = 25\text{ }^\circ\text{C}$		P_{tot}	max.	325 mW
Storage temperature		T_{stg}		-65 to +150 $^\circ\text{C}$
Junction temperature		T_j	max.	125 $^\circ\text{C}$
Operating temperature		T_{op}		-40 to +125 $^\circ\text{C}$

THERMAL RESISTANCE

Thermal resistance from junction to ambient		$R_{th\ j-a}$	max.	220 K/W
--	--	---------------	------	---------

CHARACTERISTICS

$T_j = 25\text{ }^\circ\text{C}$ unless otherwise stated

Reverse voltage $I_R = 100\text{ }\mu\text{A}$	BPX61 BPX61P	V_R	min. min.	32 V 70 V
Dark current $V_R = 10\text{ V}$	BPX61 BPX61P	I_R	typ. max. typ. max.	2 nA 30 nA 0,6 nA 1 nA
Photovoltaic voltage (see note 1) $E = 100\text{ lux}$ $E = 1000\text{ lux}$		V_L V_L	typ. typ.	285 mV 365 mV
Light current (see note 1) $V_R = 5\text{ V}$; $E = 1000\text{ lux}$		I_L	typ.	70 μA
Light current $V_R = 5\text{ V}$; $E = 1\text{ mW/cm}^2$ $\lambda = 930\text{ nm}$		SE	min. typ.	35 μA 45 μA
Wavelength at peak response $V_R = 5\text{ V}$		λ_p	typ.	850 nm
Capacitance $V_R = 0\text{ V}$ $V_R = 3\text{ V}$ $V_R = 50\text{ V}$	BPX61 BPX61P	C_{J0} C_{J3} C_{J50}	typ. typ. max. typ.	70 pF 20 pF 40 pF 6 pF
Sensitive area		A	typ.	6,75 mm ²
Temperature coefficients		K_{VL} K_{IL}	typ. typ.	-2,6 mV/ $^\circ\text{C}$ 0,2 %/ $^\circ\text{C}$
Switching times (see Figs 2 and 3) $V_R = 10\text{ V}$; $R_L = 1\text{ k}\Omega$; $\lambda = 930\text{ nm}$	BPX61 , BPX61P	t_r t_f	typ. typ.	25 ns 40 ns
$V_R = 50\text{ V}$; $R_L = 1\text{ k}\Omega$; $\lambda = 930\text{ nm}$	BPX61P	t_r t_f	typ. typ.	15 ns 20 ns

* At this voltage, the junction temperature must be lower than 70 $^\circ\text{C}$.

Noise equivalent power

$$V_R = 10 \text{ V}$$

BPX61	N_{EP}	typ.	$4,2 \times 10^{-14}$	$\frac{\text{W}}{\sqrt{\text{Hz}}}$
--------------	----------	------	-----------------------	-------------------------------------

BPX61P	N_{EP}	typ.	3×10^{-14}	$\frac{\text{W}}{\sqrt{\text{Hz}}}$
---------------	----------	------	---------------------	-------------------------------------

Detectivity

$$V_R = 10 \text{ V}$$

BPX61	D^*	typ.	$6,2 \times 10^{-12}$	$\frac{\text{cm}}{\text{W}} \frac{\sqrt{\text{Hz}}}{\text{W}}$
--------------	-------	------	-----------------------	--

BPX61P	D^*	min.	$8,6 \times 10^{-12}$	$\frac{\text{cm}}{\text{W}} \frac{\sqrt{\text{Hz}}}{\text{W}}$
---------------	-------	------	-----------------------	--

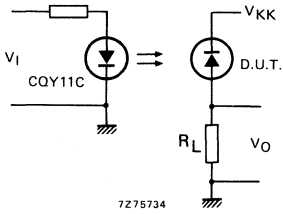

Fig. 2 Measuring circuit.

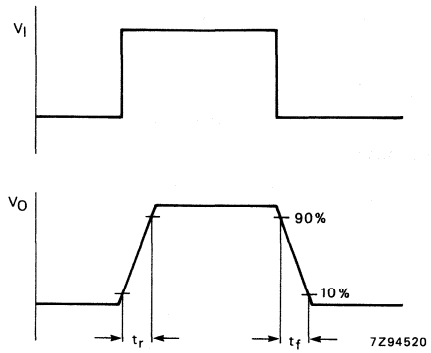

Fig. 3 Waveforms.

Note 1: Tungsten filament source with colour temperature 2856 °K.

**BPX61
BPX61P**

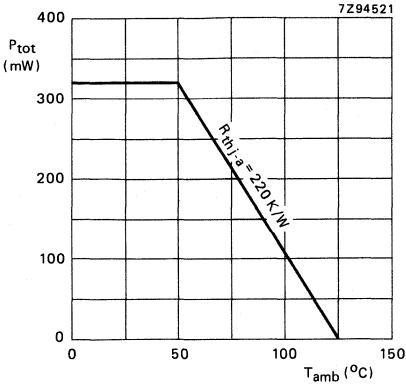

Fig. 4.

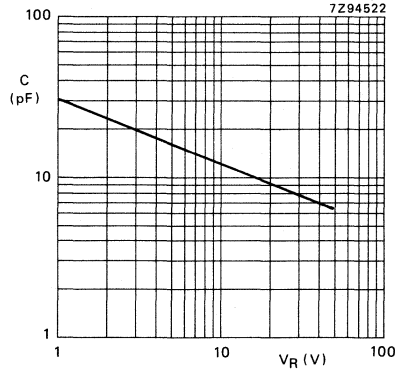

Fig. 5 $f = 1$ MHz; $T_{amb} = 25$ $^{\circ}C$;
typical values.

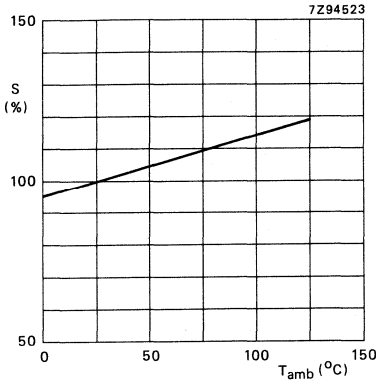

Fig. 6 $V_R = 5$ V; $E = 1000$ lux;
typical values.

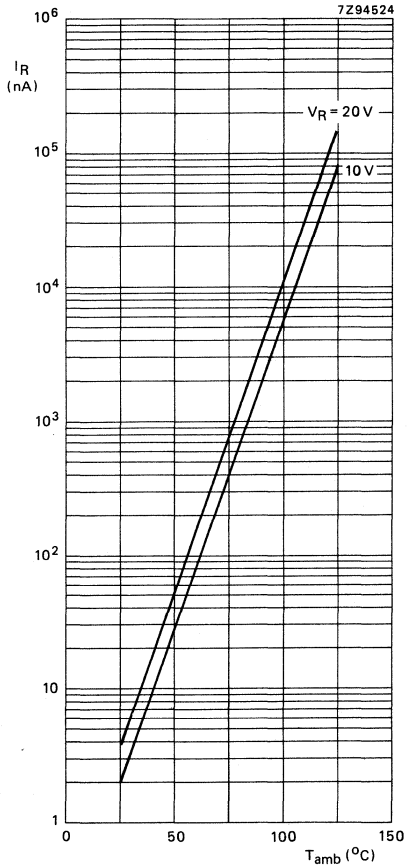

Fig. 7 $E = 0$; typical values
BP X 61.

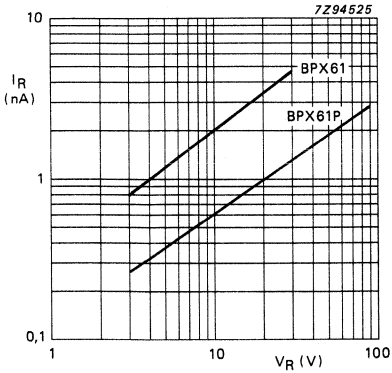

Fig. 8 $T_{amb} = 25\text{ }^\circ\text{C}$; $E = 0$; typical values.

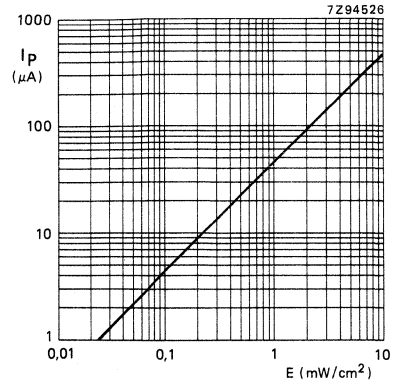

Fig. 9 $V_R = 5\text{ V}$; $T_{amb} = 25\text{ }^\circ\text{C}$; $\lambda = 930\text{ nm}$; typical values.

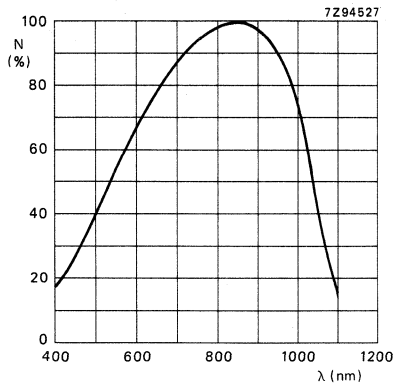

Fig. 10 Typical values.

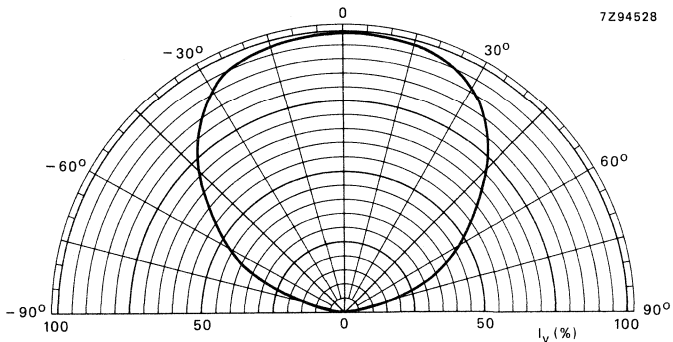

Fig. 11 $V_R = 5\text{ V}$; $E = 1000\text{ lux}$; $T_{amb} = 25\text{ }^\circ\text{C}$; typical values.

PHOTOTRANSISTOR

General purpose n-p-n silicon phototransistor with a glass lens. Inaccessible base.

QUICK REFERENCE DATA

Collector-emitter voltage	V_{CEO} max.	50 V
Collector current (d.c.)	I_C max.	20 mA
Junction temperature	T_j max.	150 °C
Collector dark (cut-off) current $V_{CE} = 30$ V	I_{CEO} <	25 nA
Collector light (cut-off) current $V_{CE} = 5$ V; $E_e = 20$ mW/cm ²	BPX71 BPX71-204	I_p 0,5 to 15 mA I_p 7 to 15 mA
Wavelength at peak response	λ_p	typ. 800 nm
Half sensitivity angle	$\theta_{1/2}$	typ. 40°

MECHANICAL DATA

Dimensions in mm

Fig. 1 SOT-71A (DO-31).

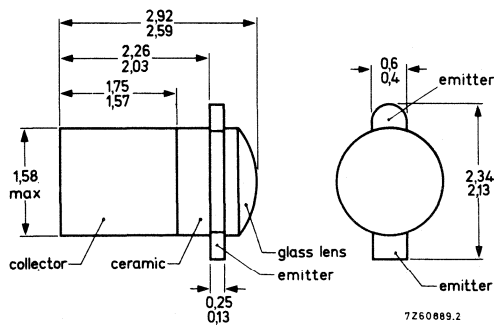

RATINGS

Limiting values in accordance with the Absolute Maximum System (IEC 134)

Collector-emitter voltage	V_{CE0}	max.	50 V
Emitter-collector voltage	V_{ECO}	max.	7 V
Collector current			
d.c.	I_C	max.	20 mA
(peak value); $t_p \leq 50 \mu s$; $\delta \leq 0,1$	I_{CM}	max.	50 mA
Total power dissipation			
up to $T_{amb} = 50 \text{ }^\circ\text{C}$	P_{tot}	max.	50 mW
up to $T_{mb} = 55 \text{ }^\circ\text{C}$	P_{tot}	max.	100 mW
Storage temperature	T_{stg}		-65 to +150 $^\circ\text{C}$
Junction temperature	T_j	max.	150 $^\circ\text{C}$

THERMAL RESISTANCE

From junction to ambient in free air	$R_{th j-a}$	=	2000 K/W
From junction to mounting base	$R_{th j-mb}$	=	950 K/W

CHARACTERISTICS

$T_{amb} = 25 \text{ }^\circ\text{C}$ unless otherwise specified

Collector dark (cut-off) current

$V_{CE} = 30 \text{ V}$	I_{CEO}	<	25 nA
$V_{CE} = 30 \text{ V}; T_{amb} = 100 \text{ }^\circ\text{C}$	I_{CEO}	<	100 μA

Collector light current

$V_{CE} = 5 \text{ V}$; tungsten filament lamp
source with colour temperature 2856 K
 $E_e = 4,75 \text{ mW/cm}^2$
 $E_e = 20 \text{ mW/cm}^2$

BPX71
BPX71-204

	I_p	typ.	1 mA
	I_p		0,5 to 15 mA
	I_p		7 to 15 mA

Collector-emitter breakdown voltage

$E = 0; I_C = 0,5 \text{ mA}$	$V_{(BR)CEO}$	>	50 V
-------------------------------	---------------	---	------

Emitter-collector breakdown voltage

$E = 0; I_C = 0,1 \text{ mA}$	$V_{(BR)ECO}$	>	7 V
-------------------------------	---------------	---	-----

Collector-emitter light saturation voltage

$I_C = 0,4 \text{ mA}; E_e = 20 \text{ mW/cm}^2; T_C = 2856 \text{ K}$	V_{CEsat}	typ.	150 mV
		<	400 mV

Wavelength at peak response

	λ_p	typ.	800 nm
--	-------------	------	--------

Bandwidth at half height

	$\Delta\lambda$	typ.	400 nm
--	-----------------	------	--------

Switching times

$I_{Con} = 0,8 \text{ mA}$; $V_{CC} = 35 \text{ V}$; $R_L = 1 \text{ k}\Omega$

Delay time

t_d typ. $2,0 \mu\text{s}$
 $< 20 \mu\text{s}$

Rise time

t_r typ. $3,0 \mu\text{s}$
 $< 30 \mu\text{s}$

Storage time

t_s typ. $0,1 \mu\text{s}$
 $< 2,0 \mu\text{s}$

Fall time

t_f typ. $2,5 \mu\text{s}$
 $< 20 \mu\text{s}$

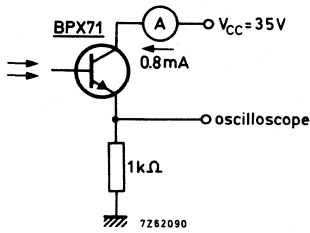

Fig. 2 Test circuit.

Light input pulse:

$t_r = t_f = 20 \text{ ns}$
 $t_p = 20 \mu\text{s}$
 $f = 500 \text{ Hz}$
 $\lambda = 800 \text{ nm}$

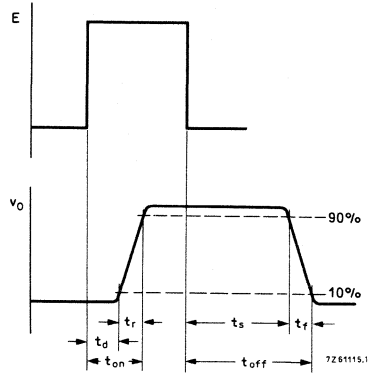

Fig. 3 Waveforms.

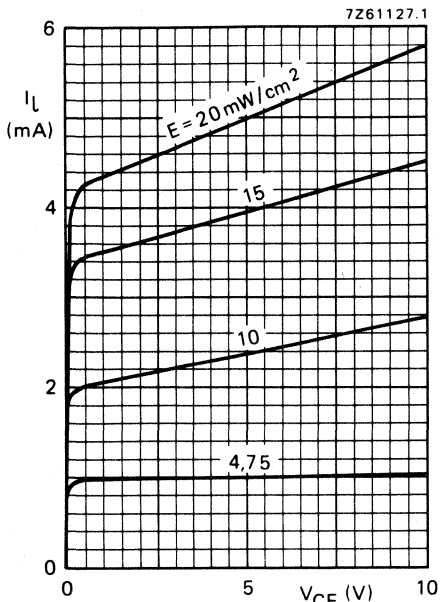

Fig. 4 Typical values; $T_{amb} = 25^\circ C$.

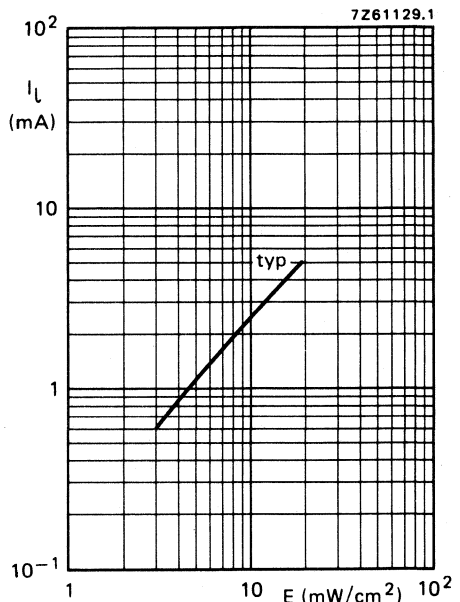

Fig. 5 $V_{CE} = 5 V$; $T_{amb} = 25^\circ C$.

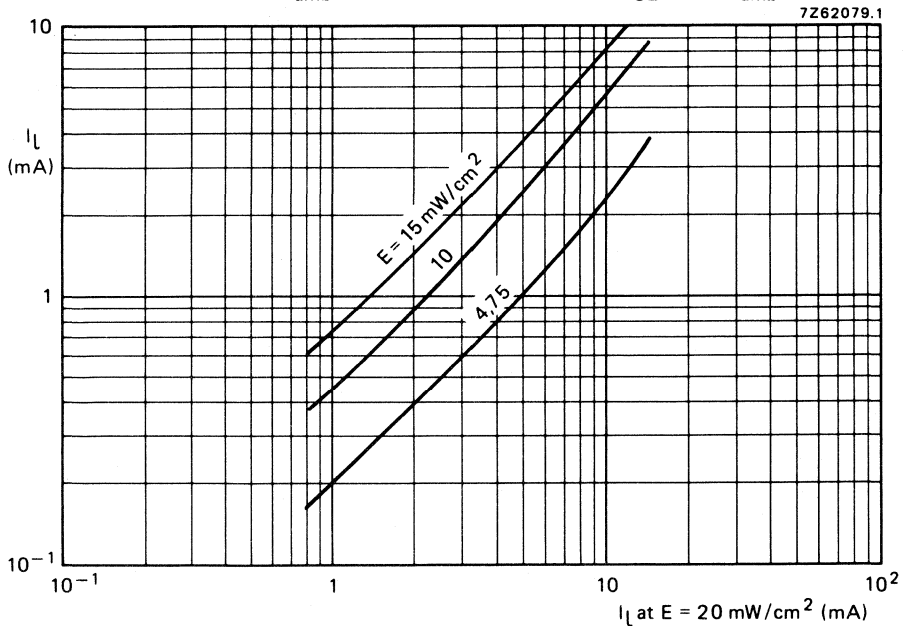

Fig. 6 $V_{CE} = 5 V$; $T_{amb} = 25^\circ C$; typical values.

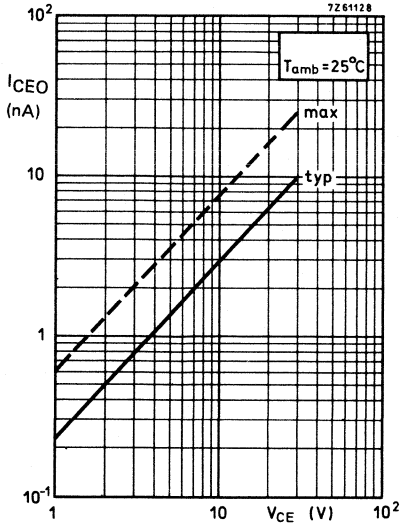

Fig. 7.

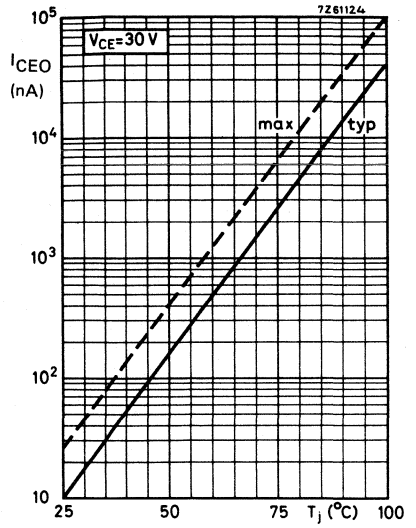

Fig. 8.

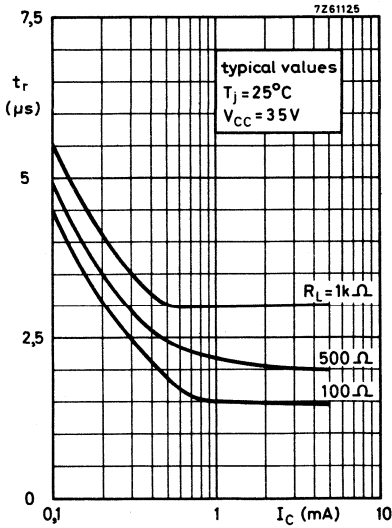

Fig. 9.

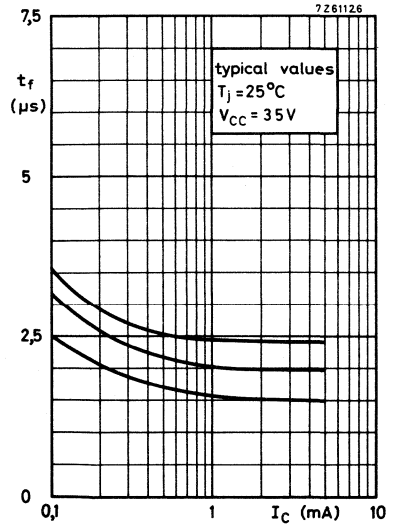

Fig. 10.

polar response of relative sensitivity

$T_{amb} = 25^{\circ}\text{C}$

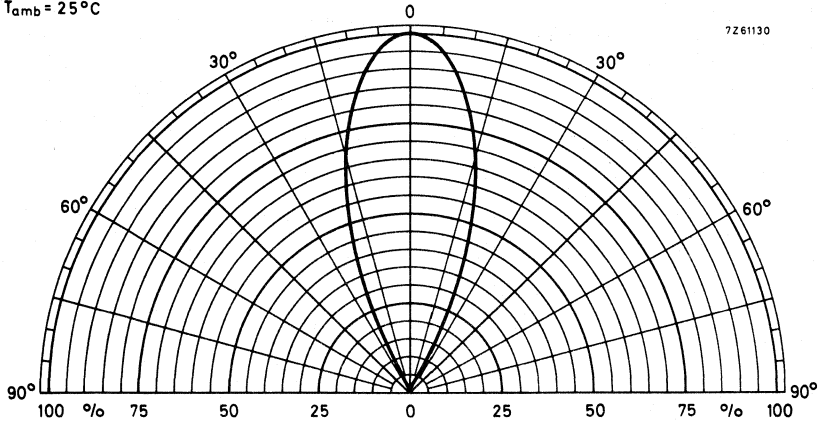

Fig. 11 Typical values.

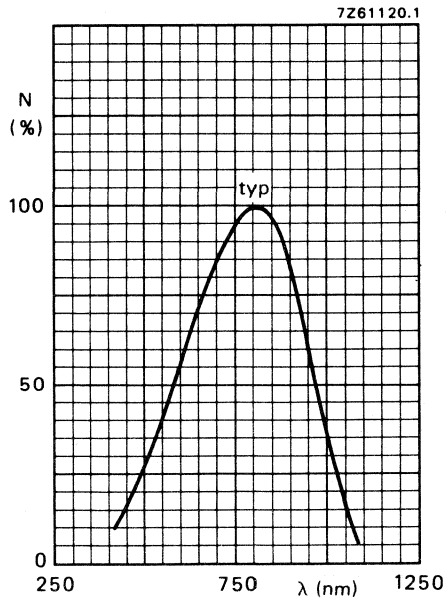

Fig. 12.

PHOTOTRANSISTOR

General purpose n-p-n silicon phototransistor with a plastic lens.

QUICK REFERENCE DATA

Collector-emitter voltage (open base)	V_{CE0}	max.	50 V	
Collector current (d.c.)	I_C	max.	25 mA	
Junction temperature	T_j	max.	125 °C	
Collector dark (cut-off) current $V_{CE} = 20$ V	I_{CE0}	<	100 nA	
Collector light (cut-off) current $V_{CE} = 5$ V; $E_v = 1000$ lx ($E_e = 4,75$ mW/cm ²)	BPX72 BPX72D BPX72E BPX72F	I_C	500 to 3000 μ A 850 to 2000 μ A 1400 to 3000 μ A 2400 to 5000 μ A	
Wavelength at peak response	λ_p	typ.	800 nm	
Half sensitivity angle	$\theta_{1/2}$	typ.	120°	

MECHANICAL DATA

Dimensions in mm

Fig. 1 SOT-70A.

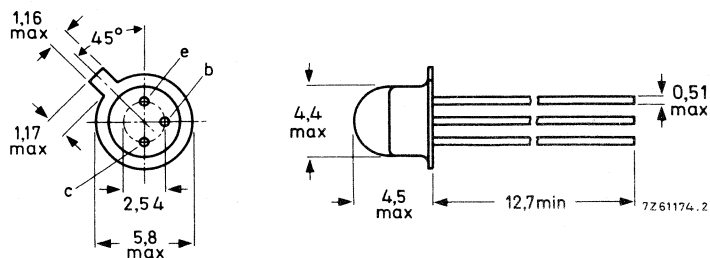

Maximum lead diameter is guaranteed only for 12,7 mm.

RATINGS

Limiting values in accordance with the Absolute Maximum System (IEC 134)

Collector-base voltage (open emitter)	V_{CBO}	max.	50 V
Collector-emitter voltage (open base)	V_{CEO}	max.	50 V
Emitter-collector voltage (open base)	V_{ECO}	max.	7 V
Collector current			
d.c.	I_C	max.	25 mA
(peak value); $t_p \leq 50 \mu s$; $\delta \leq 0,1$	I_{CM}	max.	50 mA
Total power dissipation up to $T_{amb} = 25 \text{ }^\circ\text{C}$	P_{tot}	max.	180 mW
Storage temperature	T_{stg}		-40 to + 125 $^\circ\text{C}$
Junction temperature	T_j	max.	125 $^\circ\text{C}$

THERMAL RESISTANCE

→ From junction to ambient in free air

$R_{th\ j-a}$	=	550 K/W
---------------	---	---------

CHARACTERISTICS

$I_B = 0$; $T_{amb} = 25 \text{ }^\circ\text{C}$ unless otherwise specified

Collector dark (cut-off) current

$V_{CE} = 20 \text{ V}$

I_{CEO}	typ.	10 nA
	<	100 nA

$V_{CE} = 20 \text{ V}$; $T_j = 100 \text{ }^\circ\text{C}$

I_{CEO}	typ.	10 μA
	<	100 μA

Collector light (cut-off) current

$V_{CE} = 5 \text{ V}$; tungsten filament lamp
source with colour temperature 2856 K

$E_v = 1000 \text{ lx}$ ($E_e = 4,75 \text{ mW/cm}^2$)

BPX72	I_C	500 to 3000 μA
BPX72D	I_C	850 to 2000 μA
BPX72E	I_C	1400 to 3000 μA
BPX72F	I_C	2400 to 5000 μA
	I_C	typ. 3000 μA

$E_v = 2500 \text{ lx}$ ($E_e = 12 \text{ mW/cm}^2$)

Collector-base breakdown voltage

$E = 0$; $I_C = 0,1 \text{ mA}$

$V_{(BR)CBO}$	>	50 V
---------------	---	------

Collector-emitter breakdown voltage

$E = 0$; $I_C = 1 \text{ mA}$

$V_{(BR)CEO}$	>	50 V
---------------	---	------

Emitter-collector breakdown voltage

$E = 0$; $I_C = 0,1 \text{ mA}$

$V_{(BR)ECO}$	>	7 V
---------------	---	-----

Collector capacitance

$I_E = I_e = 0$; $V_{CB} = 20 \text{ V}$

C_c	typ.	3,5 pF
-------	------	--------

Wavelength at peak response

λ_p	typ.	800 nm
-------------	------	--------

Bandwidth at half height

$\Delta\lambda$	typ.	400 nm
-----------------	------	--------

Switching times

$I_{Con} = 1 \text{ mA}; V_{CC} = 5 \text{ V}; R_L = 100 \Omega$

Delay time

t_d typ. 3,0 μs
 < 6,0 μs

Rise time

t_r typ. 6,0 μs
 < 20 μs

Storage time

t_s typ. 1,5 μs
 < 3,0 μs

Fall time

t_f typ. 4,0 μs
 < 20 μs

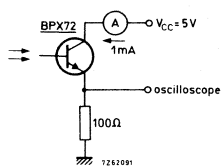

Fig. 2 Test circuit.

Light input pulse:

$t_r = t_f = 20 \text{ ns}$
 $t_p = 20 \mu s$
 $f = 500 \text{ Hz}$
 $\lambda = 800 \text{ nm}$

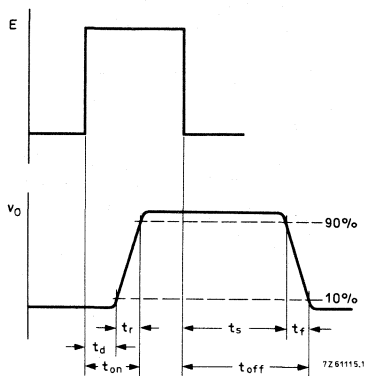

Fig. 3 Waveforms.

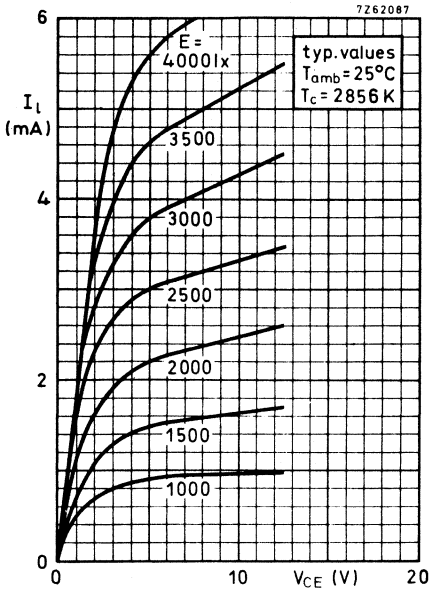

Fig. 4.

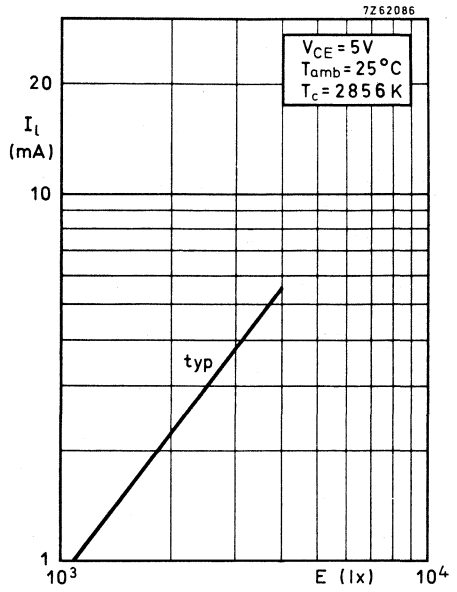

Fig. 5.

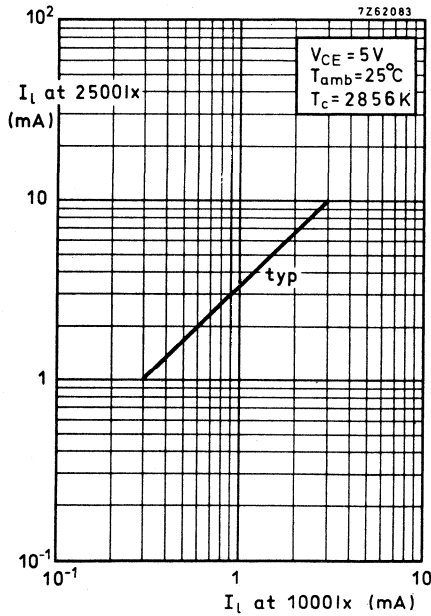

Fig. 6.

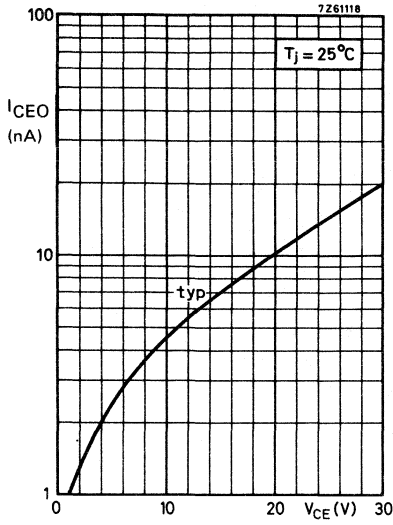

Fig. 7.

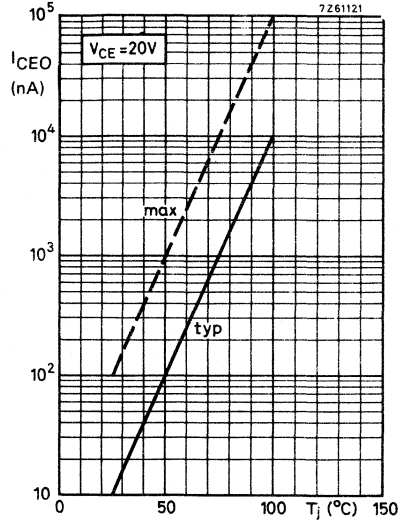

Fig. 8.

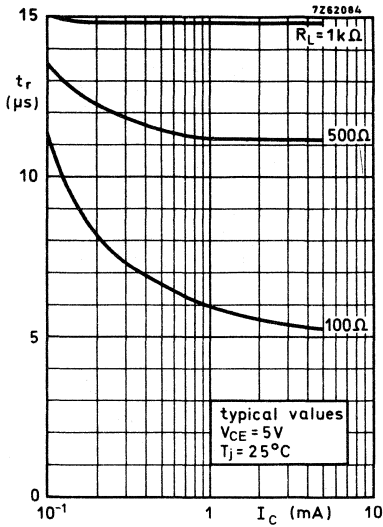

Fig. 9.

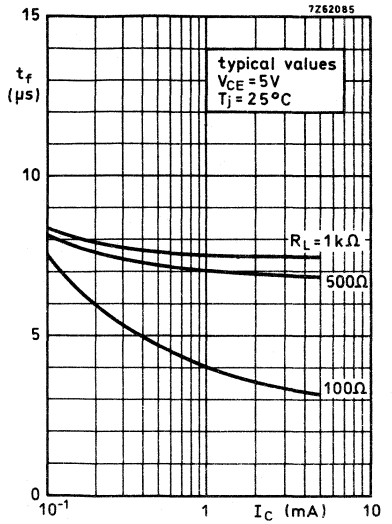

Fig. 10.

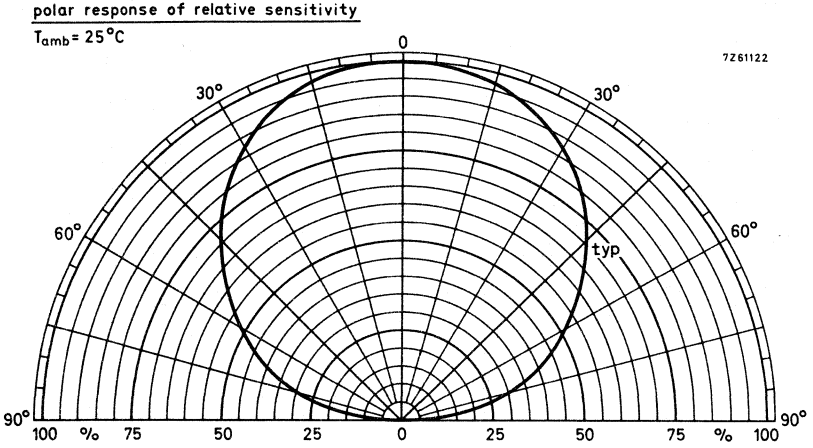

Fig. 11 Typical values.

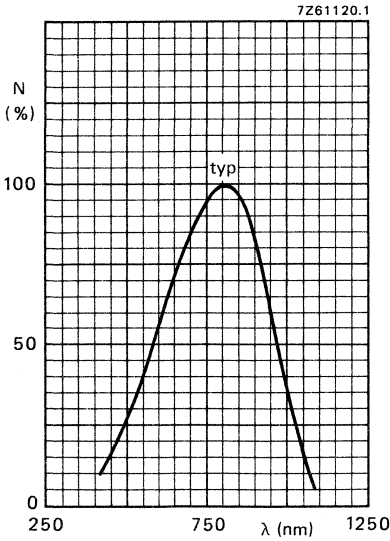

Fig. 12.

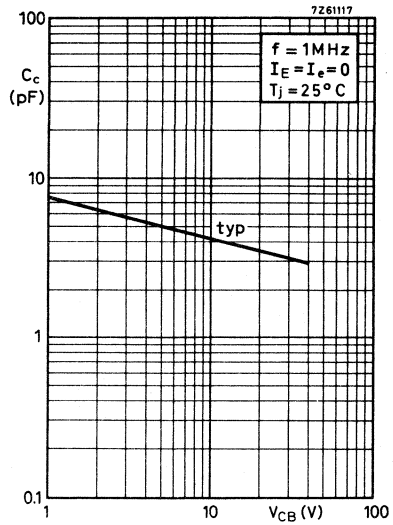

Fig. 13.

SECTION B3

Infrared light emitting diodes

HIGH-SPEED INFRARED EMITTING DIODE

Circular infrared emitting diode with diameter of 5 mm which emits infrared light at a typical peak wavelength of 830 nm (GaAlAs; infrared) when forward biased.

The CQW89A has a SOD-63 outline and is moulded in a light blue encapsulation with long leads.

The application of new GaAlAs (intrinsic) technology results in extremely short switching times and very low degradation during the devices operating life.

It is intended for remote control applications using carrier frequencies up to 1 MHz. Combination with the high-speed photo p-i-n diode BPW50 is recommended.

QUICK REFERENCE DATA

Continuous reverse voltage		V_R	max.	5 V
Forward current (d.c.)		I_F	max.	130 mA
Total power dissipation up to $T_{amb} = 25\text{ }^\circ\text{C}$		P_{tot}	max.	300 mW
Junction temperature		T_j	max.	100 $^\circ\text{C}$
Radiant intensity (on axis) static (at d.c. condition) $I_F = 100\text{ mA}$	CQW89A	I_e	min.	9 mW/sr
	CQW89A-1	I_e	min.	12 mW/sr
	CQW89A-2	I_e	min.	15 mW/sr
dynamic (at pulse condition) $I_{FM} = 100\text{ mA}$; $t_p = 0,5\text{ }\mu\text{s}$; $\delta = 0,5$		I_{eD}	typ.	0,8 I_e
Switching times (see Figs 2 and 3) $I_F = 100\text{ mA}$		t_r	typ.	30 ns
		t_f	typ.	30 ns
Wavelength at peak emission		λ_p	typ.	830 nm
Beamwidth at half-intensity directions		$\theta_{1/2}$	typ.	40 $^\circ$

MECHANICAL DATA

Fig. 1 SOD-63D2.

Dimensions in mm

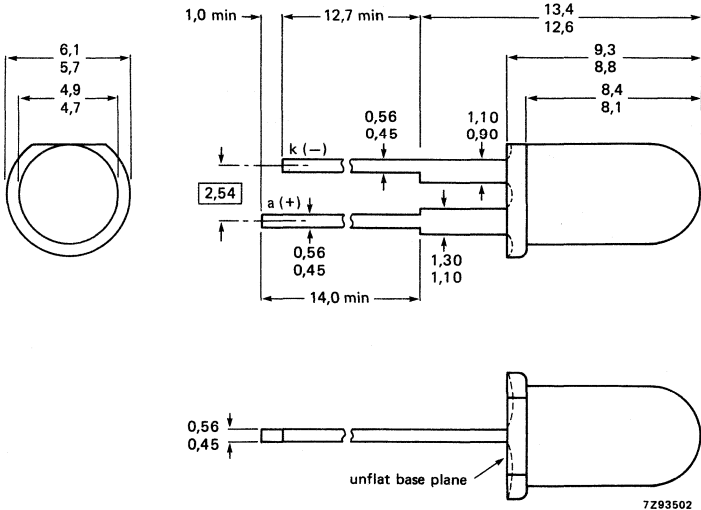

7Z93502

RATINGS

Limiting values in accordance with the Absolute Maximum System (IEC 134)

Continuous reverse voltage	V_R	max.	5 V
Forward current			
d.c.	I_F	max.	130 mA
peak value; $t_p = 10 \mu s$; $\delta = 0,01$	I_{FM}	max.	2500 mA
peak value; $t_p = 50 \mu s$; $\delta = 0,01$	I_{FM}	max.	1500 mA
Total power dissipation up to $T_{amb} = 25 \text{ }^\circ\text{C}$ with heatsink	P_{tot}	max.	300 mW
Storage temperature	T_{stg}		-55 to +100 $^\circ\text{C}$
Junction temperature	T_j	max.	100 $^\circ\text{C}$
Lead soldering temperature $t_{sld} < 10 \text{ s}$	T_{sld}	max.	260 $^\circ\text{C}$

THERMAL RESISTANCE

From junction to ambient when the device is mounted on a printed circuit board	$R_{th j-a}$	max.	350 K/W
---	--------------	------	---------

CHARACTERISTICS $T_j = 25 \text{ }^\circ\text{C}$ unless otherwise specified

Forward voltage $I_F = 1,5 \text{ A}$; $t_{on} = 50 \mu s$; $\delta = 0,01$	V_F	typ.	3,7 V
Forward voltage $I_F = 100 \text{ mA}$	V_F	typ. max.	1,7 V 2,2 V
Reverse current $V_R = 5 \text{ V}$	I_R	max.	100 μA
Diode capacitance at $f = 1 \text{ MHz}$ $V_R = 0$	C_d	typ.	200 pF
Total radiant power $I_F = 100 \text{ mA}$	ϕ_e	typ.	8 mW
Radiant intensity (on axis) static (at d.c. condition) $I_F = 100 \text{ mA}$			
	CQW89A	I_e	min. 9 mW/sr
	CQW89A-1	I_e	min. 12 mW/sr
	CQW89A-2	I_e	min. 15 mW/sr
dynamic (at pulse condition)* $I_{FM} = 100 \text{ mA}$; $t_p = 0,5 \mu s$; $\delta = 0,5$		I_{eD}	typ. 0,8 I_e

* I_{eD} = Dynamic radiant intensity (average radiant intensity level during pulse time).

Radiant power temperature coefficient

Wavelength at peak emission

$I_F = 100 \text{ mA}$

Bandwidth at half-height

$I_F = 100 \text{ mA}$

Beamwidth at half-intensity direction

$I_F = 100 \text{ mA}$

Switching times (see Figs 2 and 3)

$I_F = 100 \text{ mA}$

$k_{\phi e}$ typ. $-0,6 \text{ \%}/\text{K}$

λ_p typ. 830 nm

$\Delta\lambda$ typ. 35 nm

$\theta_{1/2}$ min. 28°
typ. 40°

t_r typ. 30 ns

t_f typ. 30 ns

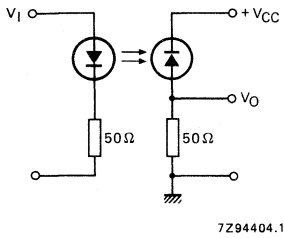

Fig. 2 Measuring circuit.

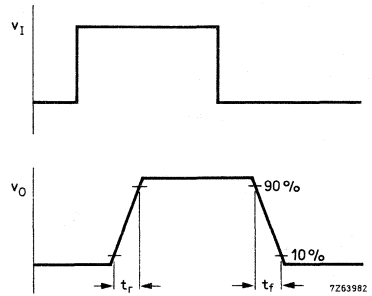

Fig. 3 Waveforms.

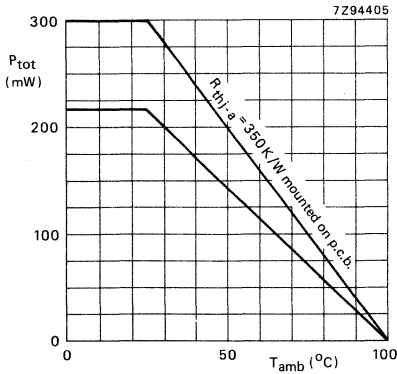

Fig. 4 Typical values.

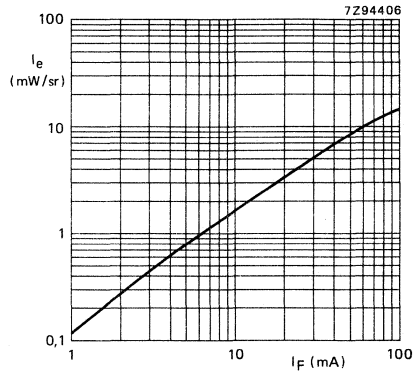

Fig. 5 $t_{ON} = 10 \mu\text{s}$; $\delta = 0,01$;
 $T_{amb} = 25^\circ\text{C}$; typical values.

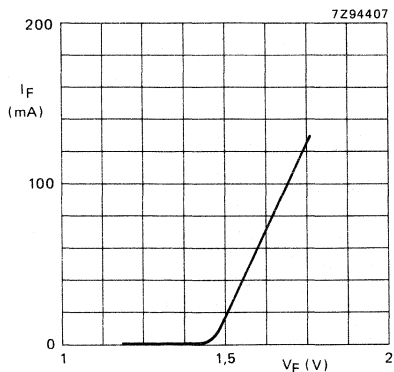

Fig. 6 $T_{amb} = 25\text{ °C}$; typical values.

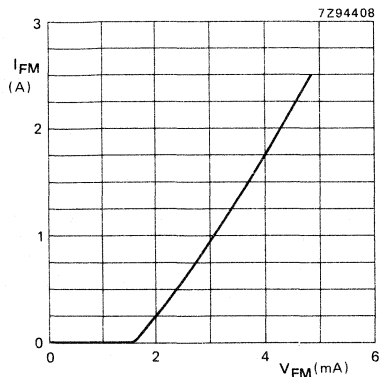

Fig. 7 $t_{on} = 10\text{ }\mu\text{s}$; $T_{amb} = 25\text{ °C}$; typical values.

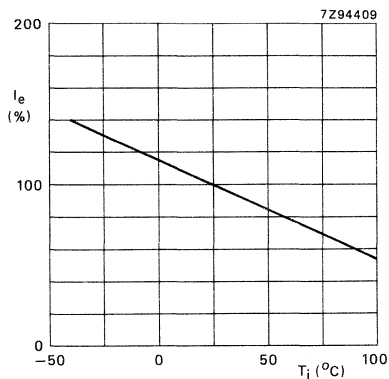

Fig. 8 $I_F = 100\text{ mA}$; typical values.

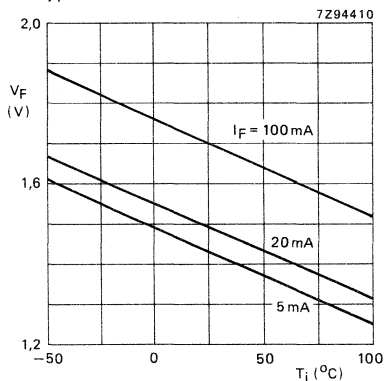

Fig. 9 Typical values.

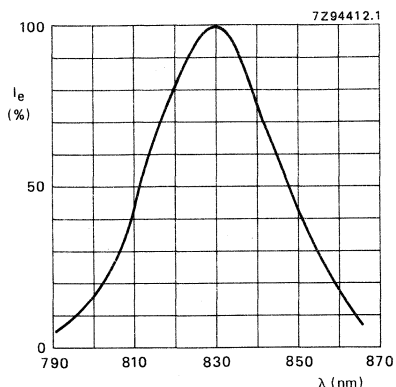

Fig. 10 Spectral response; typical values.

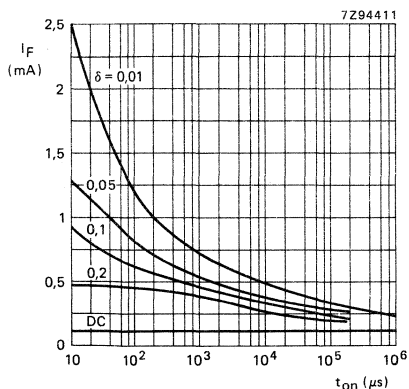

Fig. 11 Typical values.

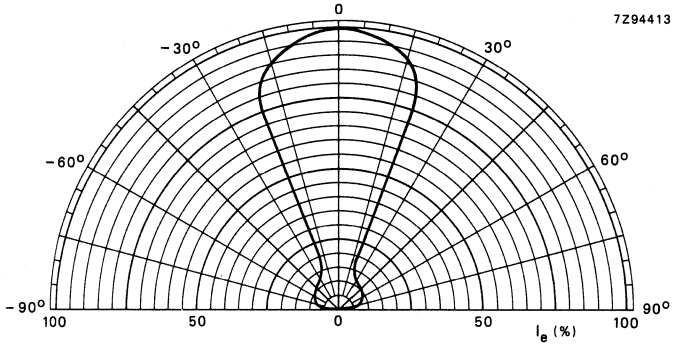

Fig. 12 Typical values.

GaAs LIGHT EMITTING DIODE

Gallium arsenide light emitting diode intended for optical coupling and encoding. It emits radiation in the near infrared when forward biased. The diode is provided with a flat glass window.

QUICK REFERENCE DATA

Continuous reverse voltage	V_R	max.	2 V
Forward current (d.c.)	I_F	max.	30 mA
Forward current (peak value) $t_p = 100 \mu\text{s}; \delta = 0,1$	I_{FRM}	max.	200 mA
Total power dissipation up to $T_{amb} = 95 \text{ }^\circ\text{C}$	P_{tot}	max.	50 mW
Total radiant power at $I_F = 20 \text{ mA}$	ϕ_e	> typ.	60 μW 100 μW
Radiant intensity (on-axis) at $I_F = 20 \text{ mA}$	I_e	typ.	64 $\mu\text{W}/\text{sr}$
Light rise time at $I_{FON} = 20 \text{ mA}$	t_r	<	100 ns
Light fall time at $I_{FON} = 20 \text{ mA}$	t_f	<	100 ns
Wavelength at peak emission	λ_p	typ.	880 nm
Thermal resistance from junction to ambient	$R_{th j-a}$	=	0,6 K/mW

MECHANICAL DATA

Dimensions in mm

Fig. 1 TO-18, except for window.

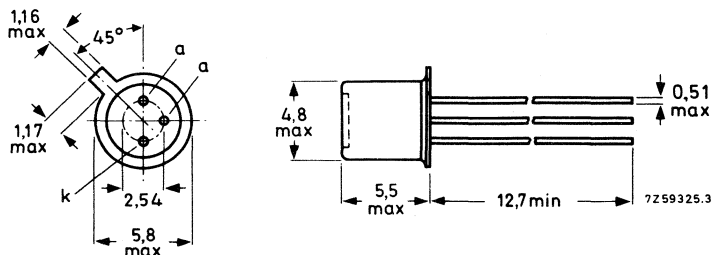

Max. lead diameter is guaranteed only for 12,7 mm.

RATINGS

Limiting values in accordance with the Absolute Maximum System (IEC 134)

Continuous reverse voltage	V_R	max.	2 V
Forward current (d.c.)	I_F	max.	30 mA
Forward current (peak value) $t_p = 100 \mu\text{s}; \delta = 0,1$	I_{FRM}	max.	200 mA
Total power dissipation up to $T_{amb} = 95 \text{ }^\circ\text{C}$	P_{tot}	max.	50 mW
Storage temperature	T_{stg}		-55 to +150 $^\circ\text{C}$
Operating junction temperature	T_j	max.	125 $^\circ\text{C}$

THERMAL RESISTANCE

From junction to ambient in free air	$R_{th j-a}$	=	0,6 K/mW
From junction to case	$R_{th j-c}$	=	0,22 K/mW

CHARACTERISTICS

 $T_{amb} = 25 \text{ }^\circ\text{C}$ unless otherwise specified

Forward voltage at $I_F = 30 \text{ mA}$	V_F	typ.	1,3 V
		<	1,6 V
$I_{FM} = 0,2 \text{ A}$	V_F	typ.	1,5 V
Reverse current at $V_R = 2 \text{ V}$	I_R	<	100 μA
Diode capacitance at $f = 1 \text{ MHz}; V_R = 0$	C_d	typ.	65 pF
		>	60 μW
Radiant output power at $I_F = 20 \text{ mA}$	ϕ_e	typ.	100 μW
	ϕ_e	typ.	50 μW
$I_F = 20 \text{ mA}; T_j = 100 \text{ }^\circ\text{C}$	ϕ_e	typ.	1,16 mW
$I_F = 200 \text{ mA}^*$	ϕ_e	typ.	1,16 mW
Radiant intensity (on-axis) at $I_F = 20 \text{ mA}$	I_e	typ.	64 $\mu\text{W}/\text{sr}$
Radiance at $I_F = 20 \text{ mA}$	L_e	typ.	1,6 mW/mm ² sr
$I_F = 200 \text{ mA}^*$	L_e	typ.	15 mW/mm ² sr
Emissive area	A_e	typ.	0,04 mm ²
Wavelength at peak emission	λ_p	typ.	880 nm
Bandwidth at half height	$\Delta\lambda$	typ.	40 nm
Switching times			
		typ.	30 ns
Rise time at $I_{FOn} = 20 \text{ mA}$	t_r	<	100 ns
		typ.	30 ns
Fall time at $I_{FOn} = 20 \text{ mA}$	t_f	<	100 ns

* $t_p = 100 \mu\text{s}; \delta = 0,1$.

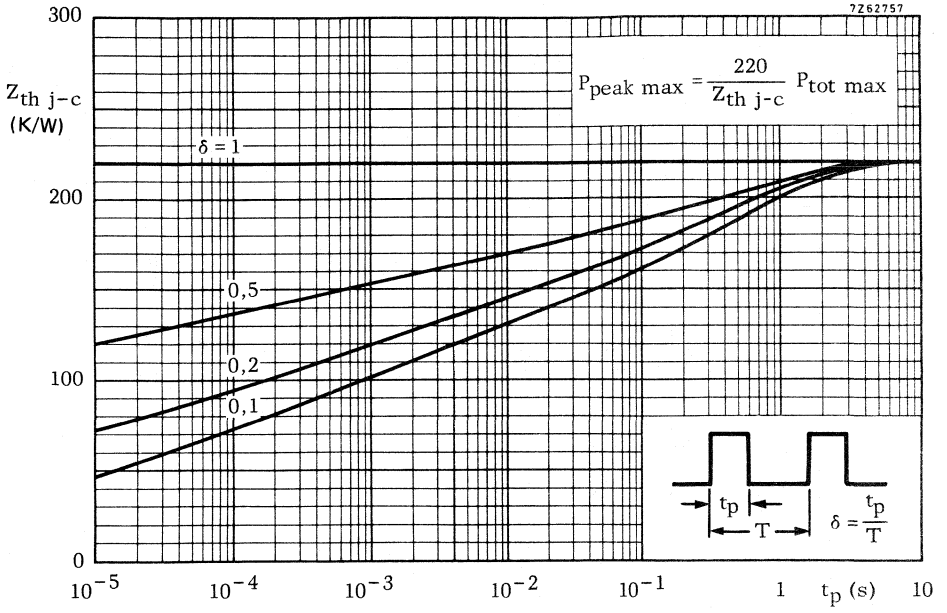

Fig. 2.

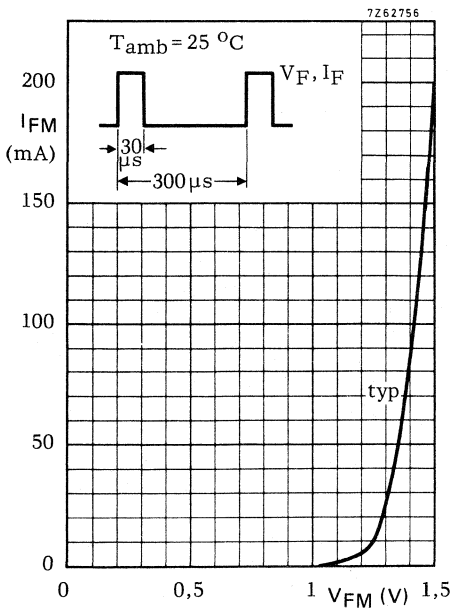

Fig. 3.

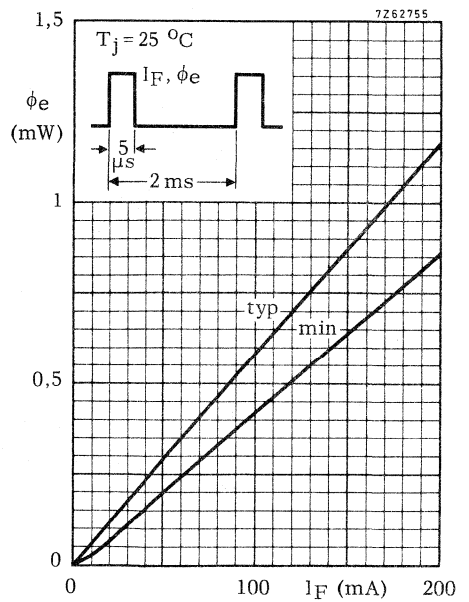

Fig. 4.

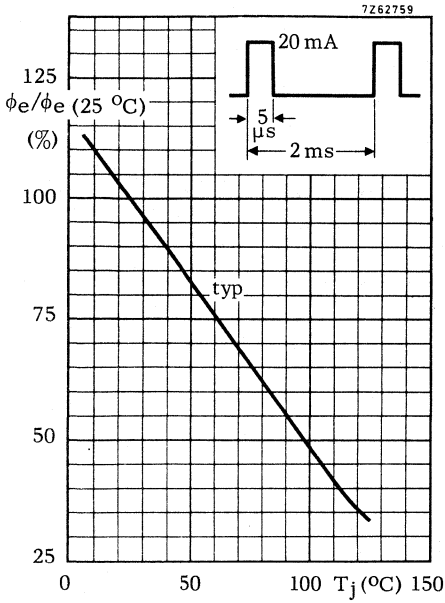

Fig. 5.

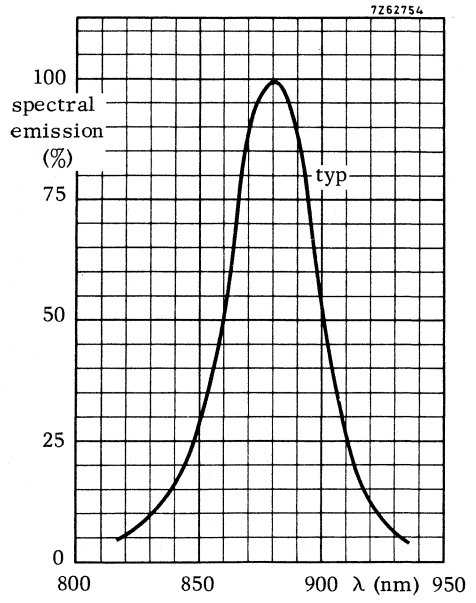

Fig. 6.

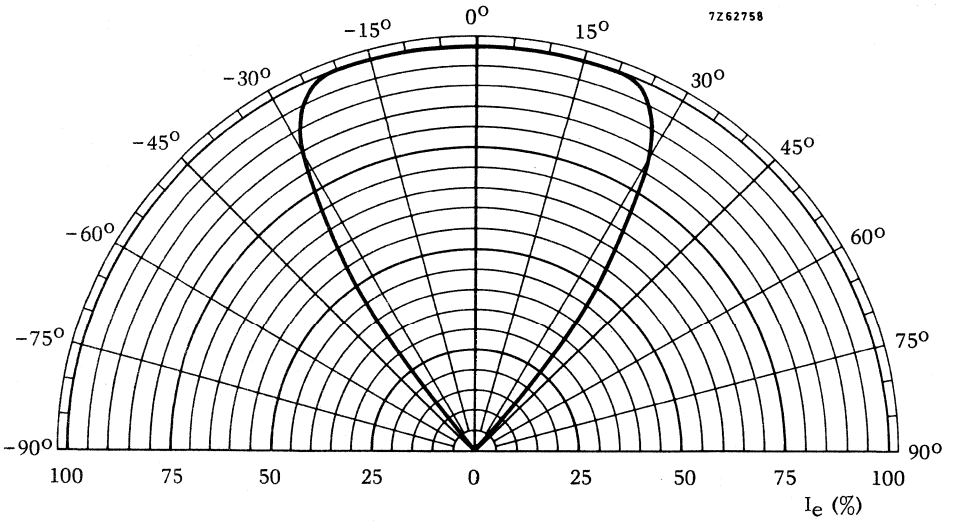

Fig. 7.

GaAs LIGHT EMITTING DIODE

Gallium arsenide light emitting diode intended for optical coupling and encoding. It emits radiation in the near infrared when forward biased. Suitable for combination with phototransistor BPX25 or BPX72.

QUICK REFERENCE DATA

Continuous reverse voltage	V_R	max.	2 V
Forward current (d.c.)	I_F	max.	30 mA
Forward current (peak value)	I_{FRM}	max.	200 mA
Total power dissipation up to $T_{amb} = 95\text{ }^\circ\text{C}$	P_{tot}	max.	50 mW
Total radiant power at $I_F = 20\text{ mA}$	ϕ_e	typ.	50 μW
Radiant intensity (on-axis) at $I_F = 20\text{ mA}$	I_e	typ.	1,25 mW/sr
Light rise time at $I_{Fon} = 20\text{ mA}$	t_r	<	100 ns
Light fall time at $I_{Fon} = 20\text{ mA}$	t_f	<	100 ns
Wavelength at peak emission	λ_p	typ.	880 nm
Thermal resistance from junction to ambient	$R_{th\ j-a}$	=	0,6 K/mW

MECHANICAL DATA

Dimensions in mm

Fig. 1 TO-18, except for lens.

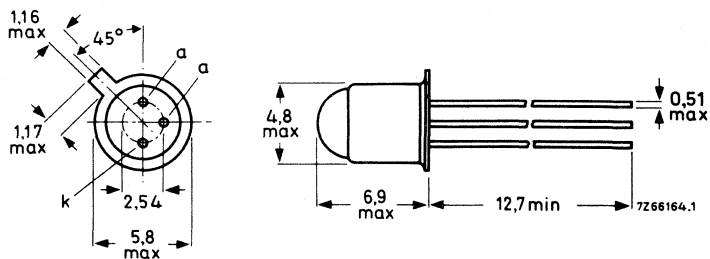

RATINGS

Limiting values in accordance with the Absolute Maximum System (IEC 134)

Continuous reverse voltage	V_R	max.	2 V
Forward current (d.c.)	I_F	max.	30 mA
Forward current (peak value) $t_p = 100 \mu s; \delta = 0,1$	I_{FRM}	max.	200 mA
Total power dissipation up to $T_{amb} = 95 \text{ }^\circ\text{C}$	P_{tot}	max.	50 mW
Storage temperature	T_{stg}		-55 to +150 $^\circ\text{C}$
Junction temperature	T_j	max.	125 $^\circ\text{C}$

THERMAL RESISTANCE

From junction to ambient in free air	$R_{th j-a}$	=	0,6 K/mW
From junction to case	$R_{th j-c}$	=	0,22 K/mW

CHARACTERISTICS $T_{amb} = 25 \text{ }^\circ\text{C}$ unless otherwise specified

Forward voltage at $I_F = 30 \text{ mA}$	V_F	typ. <	1,3 V 1,6 V
$I_{FM} = 200 \text{ mA}$	V_F	typ.	1,5 V
Reverse current at $V_R = 2 \text{ V}$	I_R	<	100 μA
Diode capacitance at $V_R = 0; f = 20 \text{ MHz}$	C_d	typ.	25 pF
Total radiant power at $I_F = 20 \text{ mA}$	ϕ_e	typ.	50 μW
Radiant intensity (on-axis) at $I_F = 20 \text{ mA}$	I_e	typ.	1,25 mW/sr
Mean irradiance on a receiving area with $D = 2 \text{ mm}$ at a distance $a = 10 \text{ mm}$ and at $I_F = 20 \text{ mA}$, measured as in Fig. 2	E_e	> typ.	0,28 mW/cm ² 0,50 mW/cm ² *

* This corresponds typically with $I_E = 0,4 \text{ mA}$ in a phototransistor BPX25 and with $200 \mu\text{A}$ in a phototransistor BPX72.

CHARACTERISTICS (continued)

Decrease of radiant power with temperature	$\frac{\Delta\phi_e}{\Delta T_j}$	typ.	0,7 %/K
Cross-section of the radiant beam between 0 to 10 mm from the lens	A_{beam}	typ.	7 mm ²
Angle between optical and mechanical axis		typ.	6 °
Wavelength at peak emission	λ_p	typ.	880 nm
Bandwidth at half height	$\theta_{1/2}$	typ.	40 nm
Switching times			
Rise time at $I_{F_{\text{On}}} = 20 \text{ mA}$	t_r	typ.	30 ns
		<	100 ns
Fall time at $I_{F_{\text{On}}} = 20 \text{ mA}$	t_f	typ.	30 ns
		<	100 ns

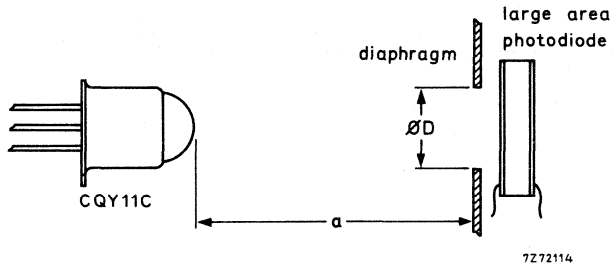

Fig. 2.

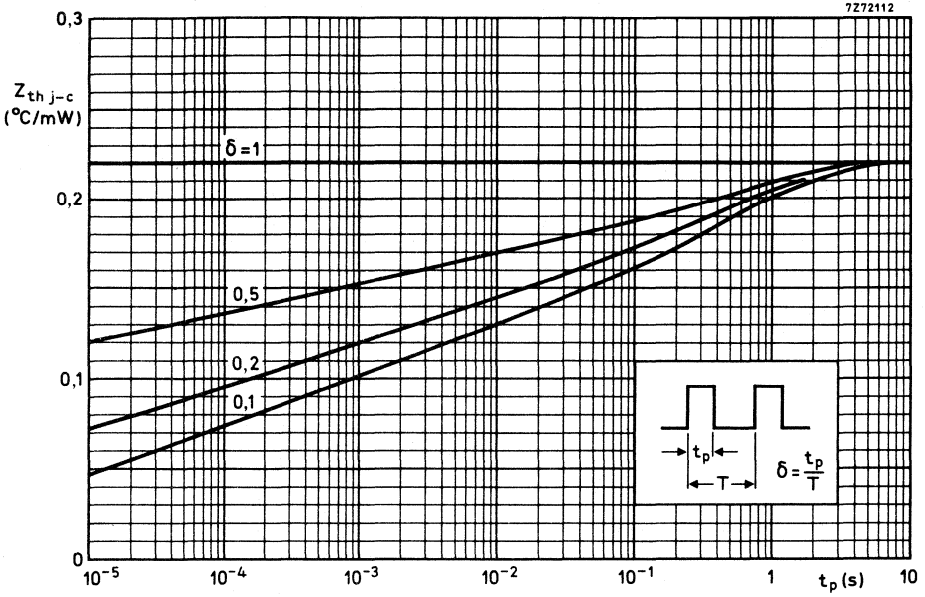

Fig. 3.

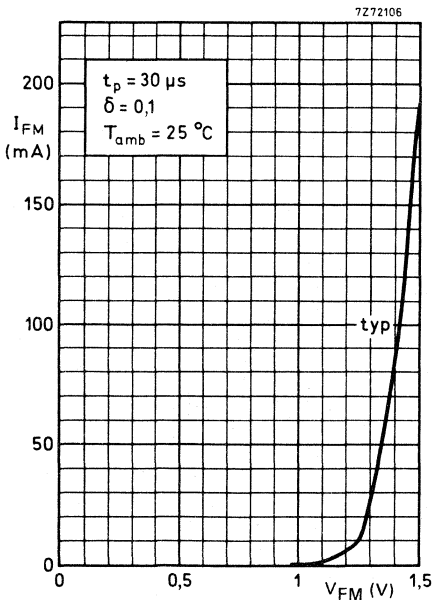

Fig. 4.

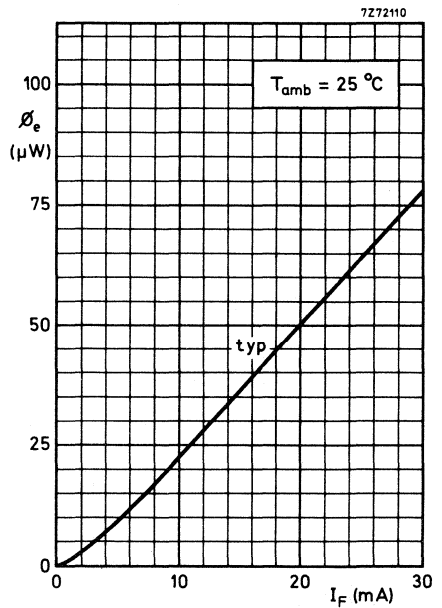
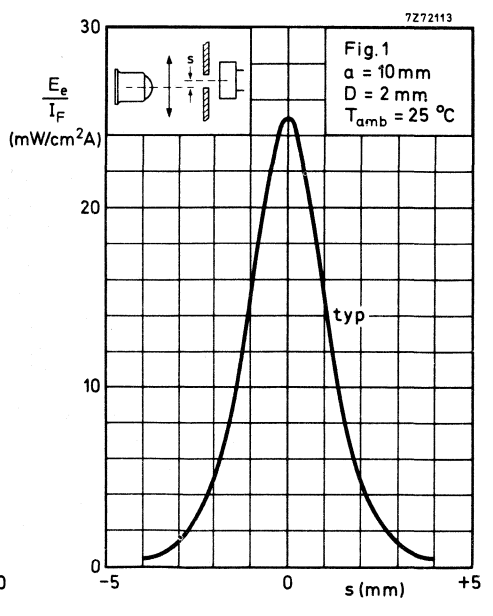
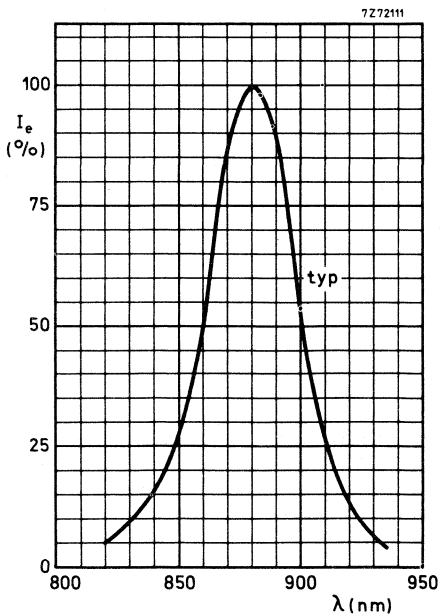
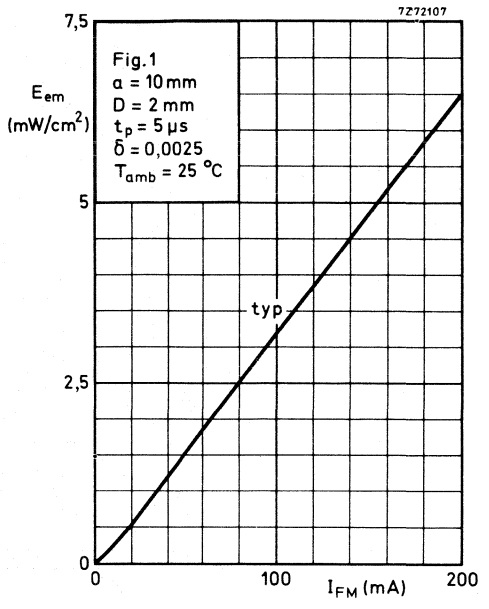
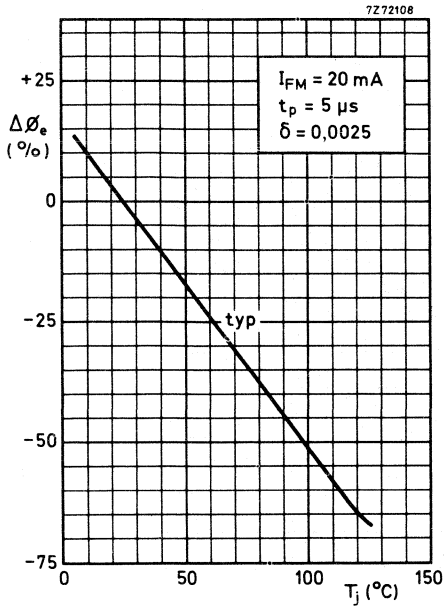

Fig. 5.



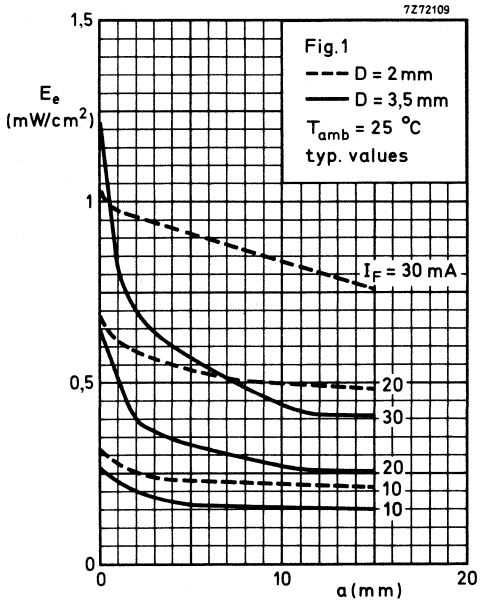

Fig. 10.

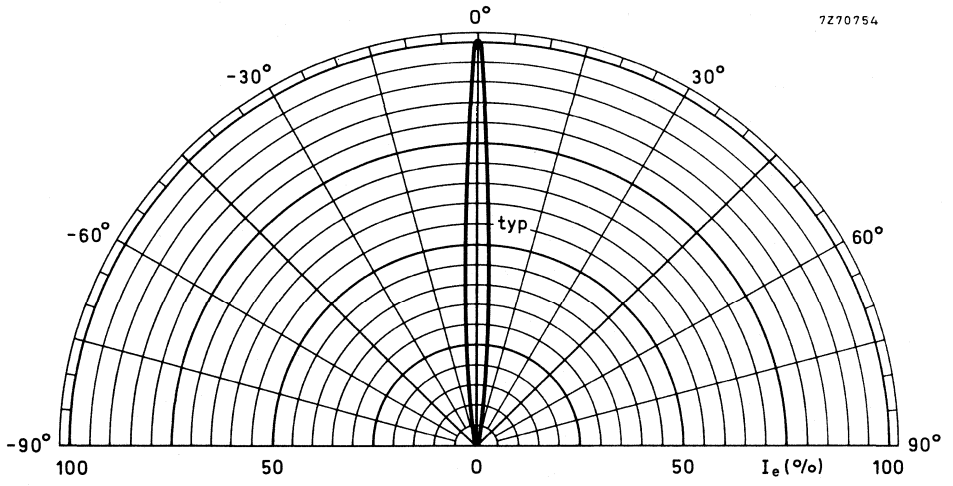

Fig. 11.

GaAs LIGHT EMITTING DIODES

Epitaxial gallium arsenide light emitting diodes intended for optical coupling and encoding. They emit radiation in the near infrared when forward biased. Envelopes like TO-18. Suitable for combination with phototransistors BPX25 and BPX72.

QUICK REFERENCE DATA

Continuous reverse voltage	V_R	max.	5 V
Forward current (d.c.)	I_F	max.	100 mA
Total power dissipation up to $T_{amb} = 25\text{ }^\circ\text{C}$	P_{tot}	max.	150 mW
Radiant intensity (on-axis) at $I_F = 50\text{ mA}$	CQY49B	I_e	max. 0,3 mW/sr
	CQY49C	I_e	max. 3 mW/sr
Wavelength at peak emission	λ_p	typ.	930 nm
Thermal resistance from junction to ambient	$R_{th\ j-a}$	=	0,665 K/mW

MECHANICAL DATA

Dimensions in mm

Fig. 1 CQY49B: TO-18 except for window.

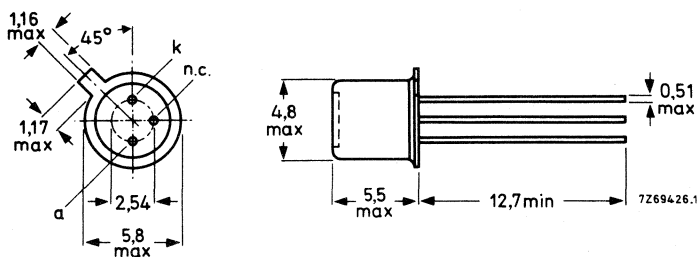
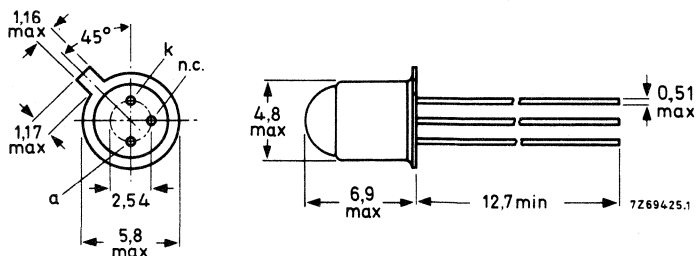

Fig. 1b CQY49C: TO-18 except for lens.



RATINGS

Limiting values in accordance with the Absolute Maximum System (IEC 134)

Continuous reverse voltage	V_R	max.	5	V
Forward current (d.c.)	I_F	max.	100	mA
Forward current (peak value) $t_p < 10 \mu s$; $\delta < 0,01$	I_{FRM}	max.	1	A
Total power dissipation up to $T_{amb} = 25 \text{ }^\circ\text{C}$	P_{tot}	max.	150	mW
Storage temperature	T_{stg}		-55 to +100	$^\circ\text{C}$
Operating junction temperature	T_j	max.	125	$^\circ\text{C}$
Lead soldering temperature > 1,5 mm from the body; $t_{sld} < 10 \text{ s}$	T_{sld}	max.	260	$^\circ\text{C}$

THERMAL RESISTANCE

From junction to ambient in free air	$R_{th j-a}$	=	0,665	K/mW
From junction to case	$R_{th j-c}$	=	0,3	K/mW

CHARACTERISTICS

$T_j = 25 \text{ }^\circ\text{C}$ unless otherwise specified

			CQY49B	CQY49C
Forward voltage at $I_F = 50 \text{ mA}$	V_F	typ.	1,3	V
		max.	1,5	V
Reverse current at $V_R = 5 \text{ V}$	I_R	max.	100	μA
Diode capacitance $V_R = 0$; $f = 1 \text{ MHz}$	C_d	typ.	55	pF
Radiant intensity (on-axis) at $I_F = 50 \text{ mA}$	I_e	min.	0,3	3 mW/sr
		typ.	0,5	5 mW/sr
Wavelength at peak emission	λ_p	typ.	930	nm
Bandwidth at half height	$\Delta\lambda$	typ.	50	nm
Beamwidth between half-intensity directions	$\theta_{1/2}$	typ.	80 $^\circ$	150 $^\circ$
Switching times $I_{Fon} = 50 \text{ mA}$; $t_p = 2 \mu s$; $f = 45 \text{ kHz}$				
Rise time	t_r	typ.	600	ns
Fall time	t_f	typ.	350	ns

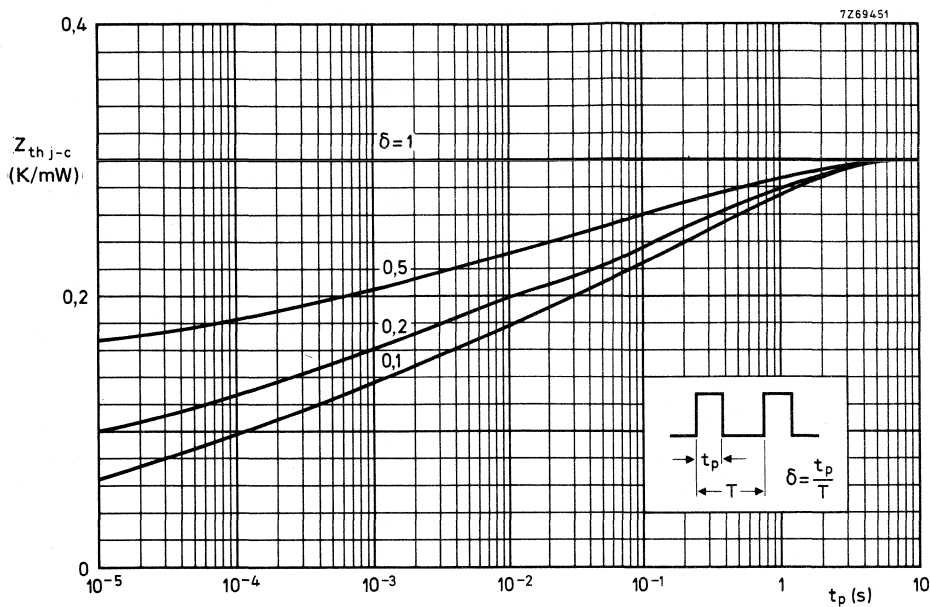

Fig. 2 Typical values.

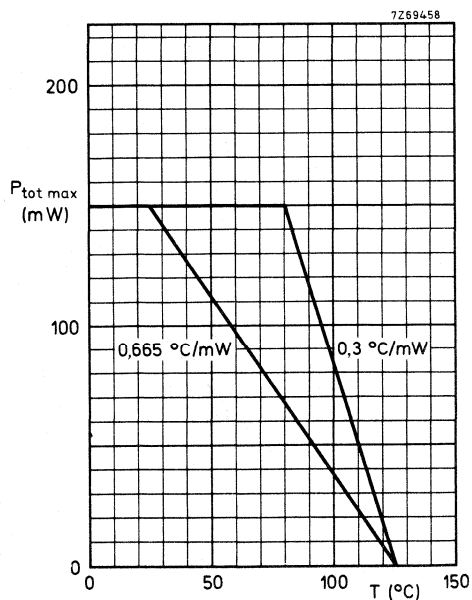

Fig. 3.

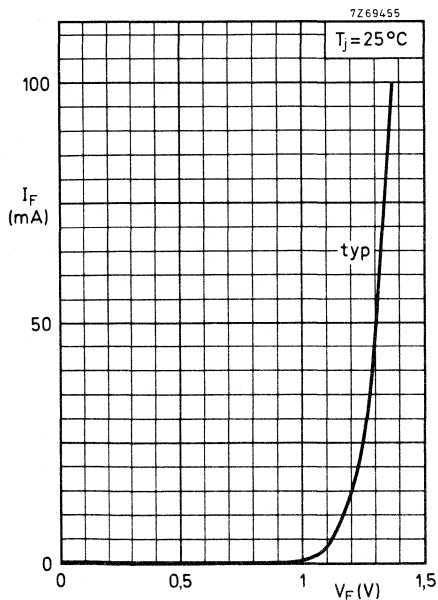

Fig. 4.

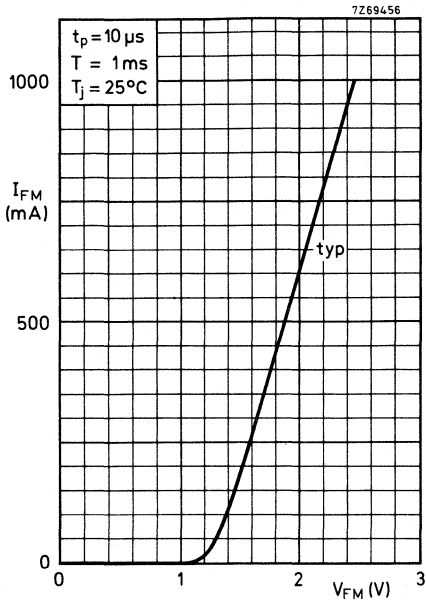

Fig. 5.

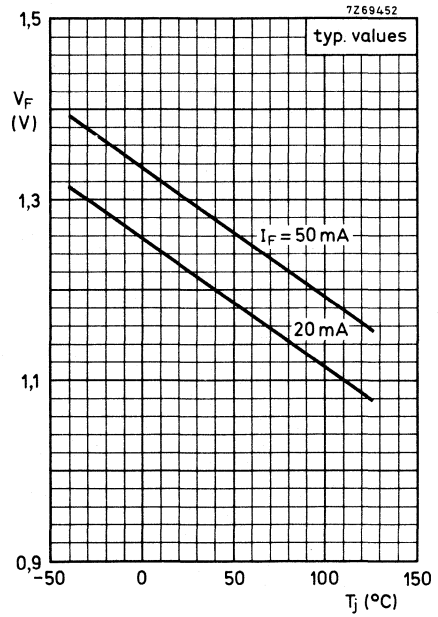

Fig. 6.

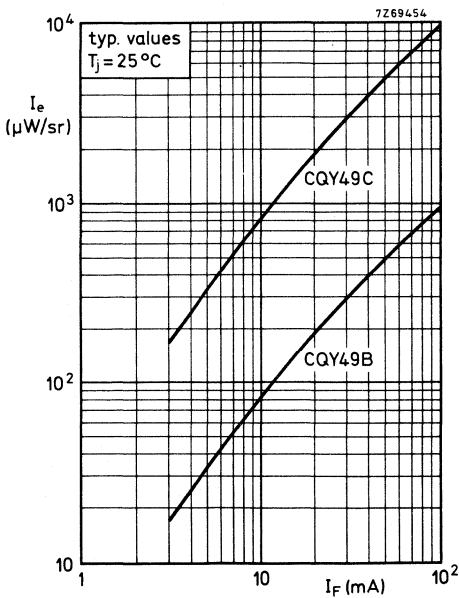

Fig. 7.

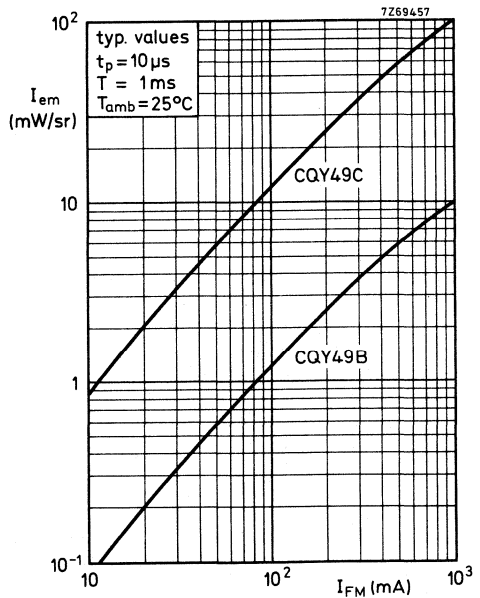

Fig. 8.

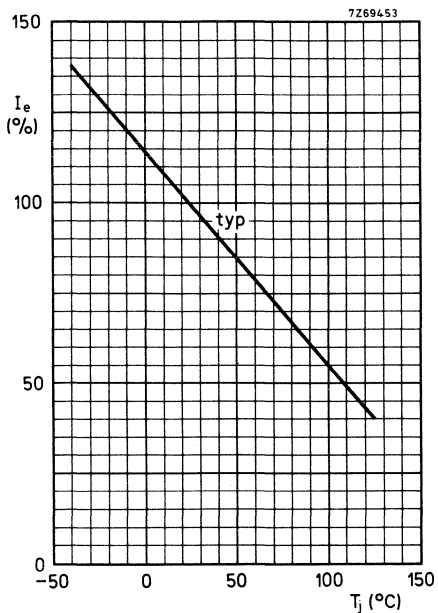

Fig. 9.

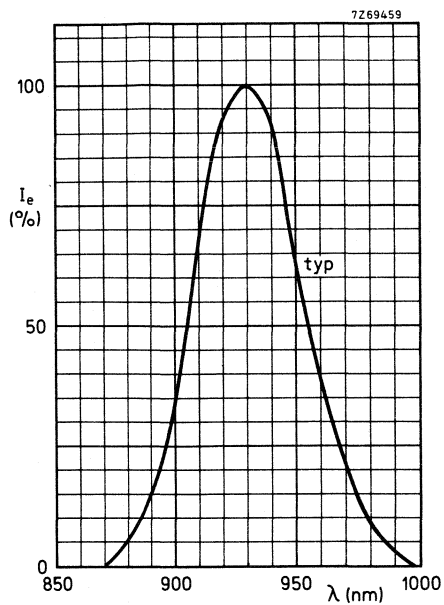

Fig. 10.

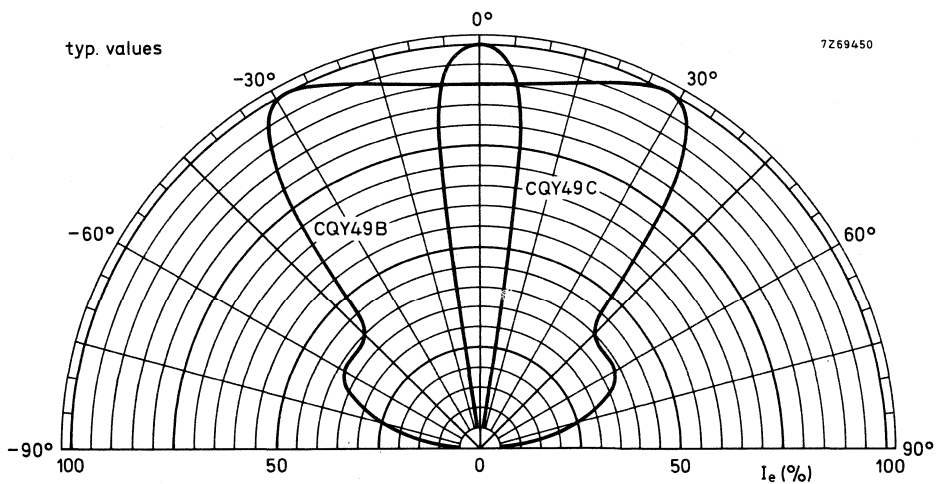

Fig. 11.

GaAs LIGHT EMITTING DIODE

Gallium arsenide light emitting diodes which emit near-infrared light when forward biased. Ceramic-metal envelope with glass lens like BPX71, suitable for matrix layout on printed circuit boards. In conjunction with BPX71 also suitable for punched card reading.

QUICK REFERENCE DATA

Continuous reverse voltage	V_R	max.	2	V
Forward current (d.c.)	I_F	max.	100	mA
Total power dissipation up to $T_{amb} = 25^\circ C$ mounted on printed circuit board	P_{tot}	max.	150	mW
Total radiant power at $I_F = 20$ mA	ϕ_e	>	CQY50 160	CQY52 400 μW
Radiant intensity (on-axis) at $I_F = 20$ mA	I_e	>	180	450 $\mu W/sr$
Wavelength at peak emission	λ_p	typ.	930	nm

MECHANICAL DATA

Dimensions in mm

Fig. 1 DO-31, except for length.

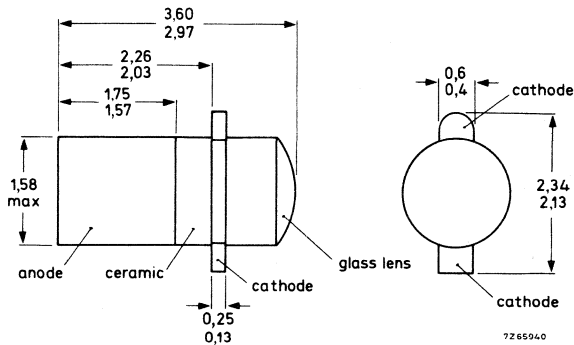

RATINGS

Limiting values in accordance with the Absolute Maximum System (IEC 134)

Continuous reverse voltage	V_R	max.	2	V
Forward current (d.c.)	I_F	max.	100	mA
Forward current (peak value) $t_p = 10 \mu s; \delta = 0,01$	I_{FRM}	max.	500	mA
Storage temperature	T_{stg}		-65 to +150	°C
Operating junction temperature	T_j	max.	125	°C
Total power dissipation up to $T_{amb} = 25 \text{ °C}$ device mounted on printed circuit board *	P_{tot}	max.	150	mW

THERMAL RESISTANCE

From junction to ambient,
device mounted on printed circuit board *

$$R_{th\ j-a} = 0,66 \text{ K/mW}$$

CHARACTERISTICS

$T_{amb} = 25 \text{ °C}$ unless otherwise specified

			CQY50	CQY52
Forward voltage $I_F = 50 \text{ mA}$	V_F	typ. <	1,3 1,5	1,3 V 1,5 V
$I_F = 500 \text{ mA}; t_p = 10 \mu s; \delta = 0,01$	V_F	typ.	2,3	2,3 V
Reverse current at $V_R = 2 \text{ V}$	I_R	<	100	100 μA
Diode capacitance at $V_R = 0; f = 1 \text{ MHz}$	C_d	typ.	45	45 pF
Total radiant power $I_F = 20 \text{ mA}$	ϕ_e	>	160	400 μW
$I_F = 50 \text{ mA}$	ϕ_e	typ.	700	1500 μW
Radiant intensity (on-axis) at $I_F = 20 \text{ mA}$	I_e	>	180	450 $\mu W/sr$
Wavelength at peak emission	λ_p	typ.	930	930 nm
Bandwidth at half height	$\Delta\lambda$	typ.	40	40 nm
Beamwidth between half-intensity directions	$\theta_{1/2}$	typ.	35°	35°
Switching times $I_{Fon} = 20 \text{ mA}; t_p = 2 \mu s; f = 45 \text{ kHz}$				
Rise time	t_r	typ.	600	600 ns
Fall time	t_f	typ.	350	350 ns

* With copper islands of 6 x 2 mm on both sides of 1,6 mm glass-epoxy printed circuit board;
thickness of copper 35 μm .

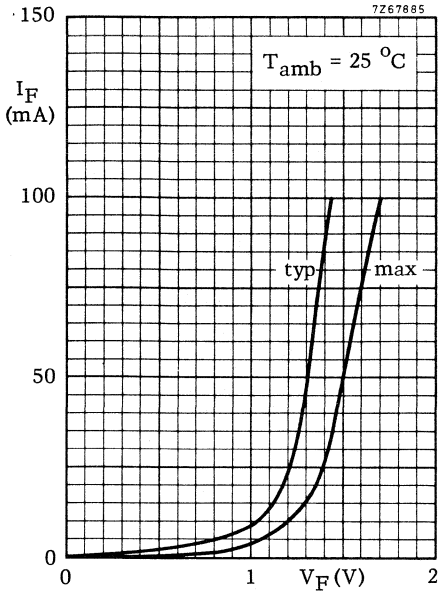

Fig. 2.

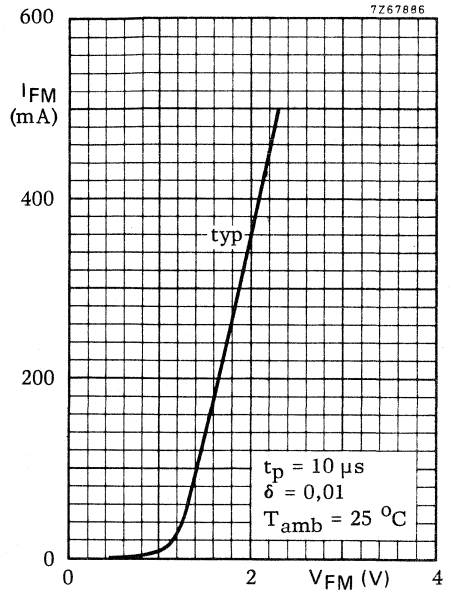

Fig. 3.

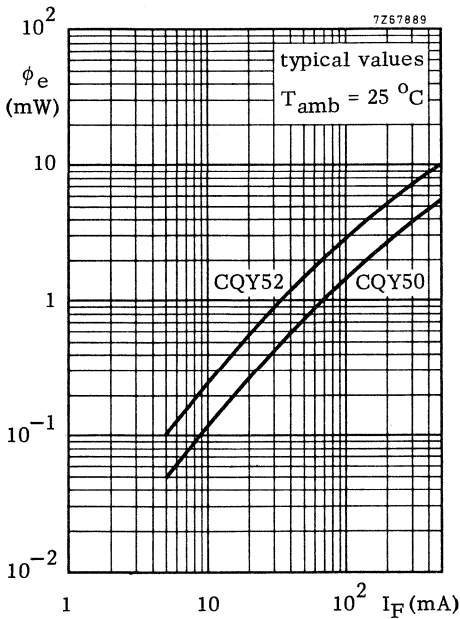

Fig. 4.

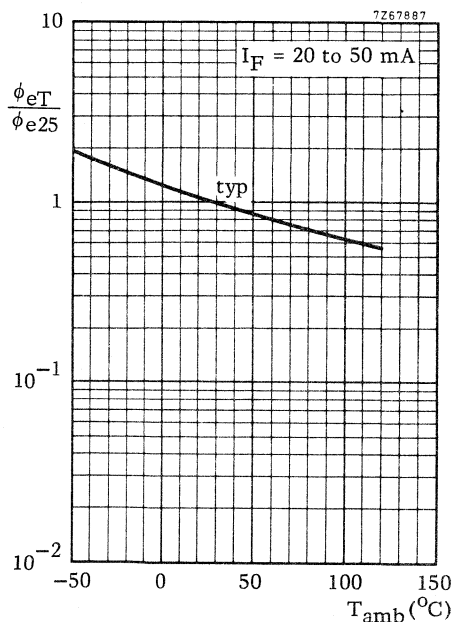

Fig. 5.

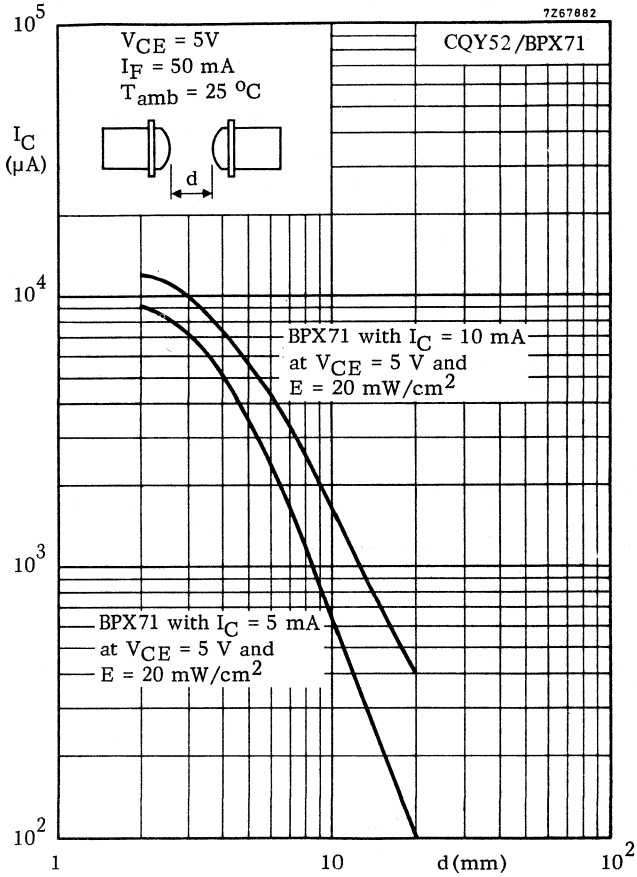

Fig. 6 Typical values.

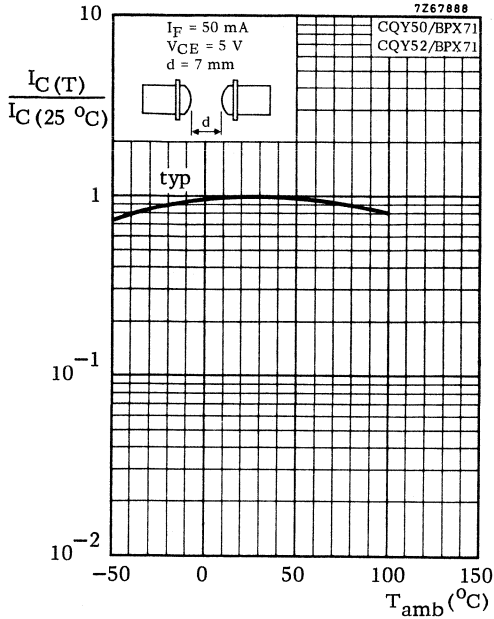

Fig. 7.

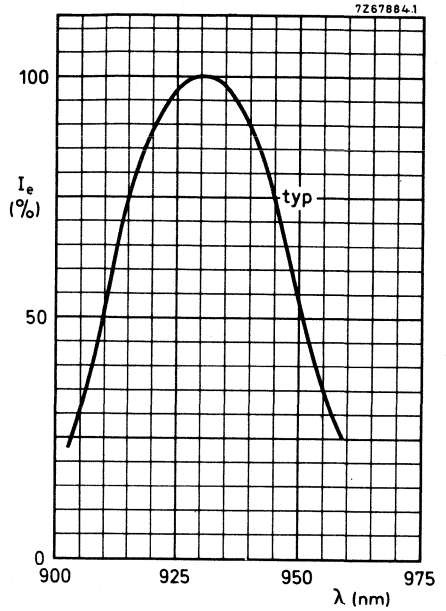

Fig. 8.

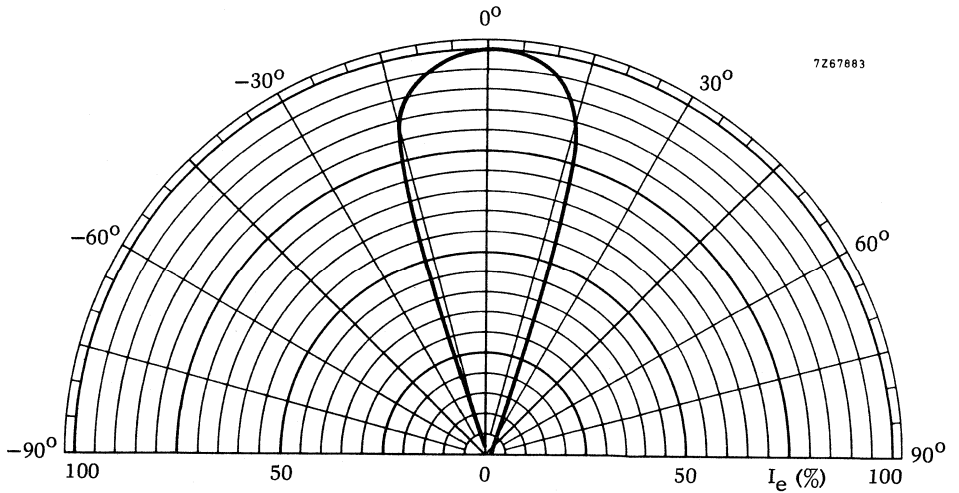

Fig. 9 Typical values.

DEVELOPMENT DATA

This data sheet contains advance information and specifications are subject to change without notice.

CQY53S

LIGHT EMITTING DIODE

Circular light emitting diode with diameter of 6 mm which emits visible red light at a maximum peak wavelength of 690 nm (GaPAs; red) when forward biased.

The CQY53S has an FO-81 outline with a clear plastic lens.

QUICK REFERENCE DATA

Continuous reverse voltage	V_R	max.	3 V
Forward current (d.c.)	I_F	max.	50 mA
Total power dissipation up to $T_{amb} = 45^\circ\text{C}$	P_{tot}	max.	125 mW
Junction temperature	T_j	max.	85 °C
Luminous intensity $I_F = 10\text{ mA}$	I_v	min.	400 μcd
Wavelength at peak emission	λ_p	max.	690 nm
Beamwidth at half-intensity directions	$\theta_{1/2}$	min.	90 °

MECHANICAL DATA

Dimensions in mm

Fig. 1 FO-81.

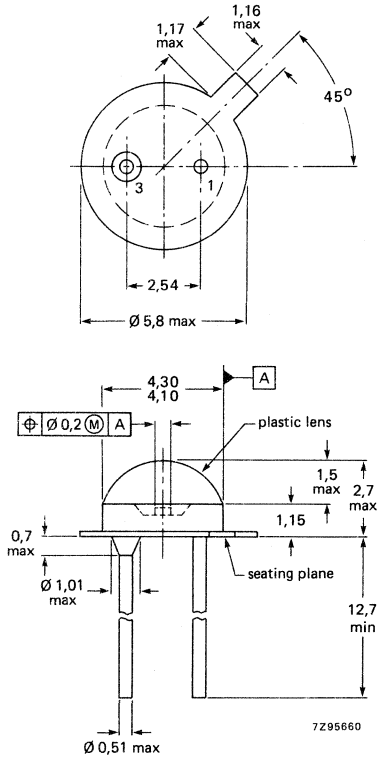

- 1 : anode
- 3 : cathode (connected to case)

RATINGS

Limiting values in accordance with the Absolute Maximum System (IEC 134)

Continuous reverse voltage	V_R	max.	3 V
Forward current (d.c.)	I_F	max.	50 mA
Total power dissipation up to $T_{amb} = 45\text{ }^\circ\text{C}$	P_{tot}	max.	125 mW
Storage temperature	T_{stg}		-40 to +100 $^\circ\text{C}$
Junction temperature	T_j	max.	85 $^\circ\text{C}$
Lead soldering temperature $t_{sld} < 7\text{ s}$	T_{sld}	max.	260 $^\circ\text{C}$

THERMAL RESISTANCE

From junction to ambient	$R_{th\ j-a}$	max.	320 K/W
--------------------------	---------------	------	---------

CHARACTERISTICS $T_j = 25\text{ }^\circ\text{C}$ unless otherwise specified

Forward voltage $I_F = 10\text{ mA}$	V_F	min. typ.	1,4 V 1,8 V
Reverse current $V_R = 3\text{ V}$	I_R	max.	100 μA
Luminous intensity $I_F = 10\text{ mA}$	I_v	min. max.	400 μcd 1000 μcd
Wavelength at peak emission	λ_p	min. max.	630 nm 690 nm
Bandwidth at half height	$\Delta\lambda$	typ. max.	20 nm 40 nm
Beamwidth at half-intensity directions	$\theta_{1/2}$	min.	90 $^\circ$

DEVELOPMENT DATA

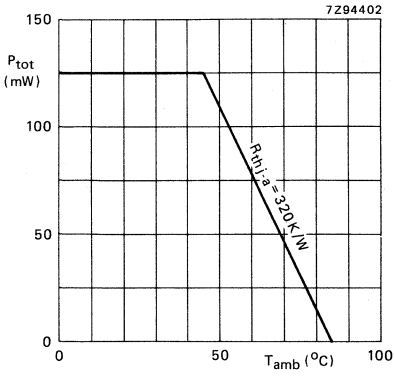

Fig. 2.

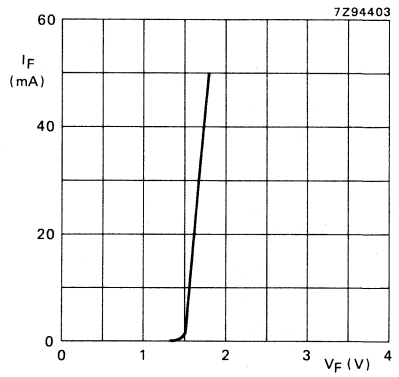

Fig. 3 Typical values.

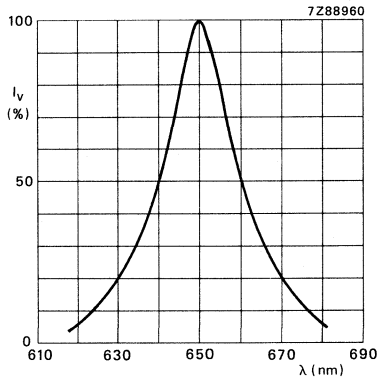

Fig. 4 Typical values.

RATINGS

Limiting values in accordance with the Absolute Maximum System (IEC 134)

Continuous reverse voltage	V_R	max.	5 V
Forward current			
d.c.	I_F	max.	50 mA
(peak value); $t_p = 10 \mu s$; $\delta = 0,01$	I_{FRM}	max.	200 mA
Total power dissipation up to $T_{amb} = 25^\circ C$ (see Fig. 2)	P_{tot}	max.	100 mW
Storage temperature	T_{stg}		-55 to + 100 °C
Junction temperature	T_j	max.	100 °C
Lead soldering temperature			
→ > 1,5 mm from the seating plane; $t_{sld} < 7 s$	T_{sld}	max.	260 °C

THERMAL RESISTANCE

From junction to ambient,

→ device mounted on a printed-circuit board	$R_{th j-a}$	=	750 K/W
---	--------------	---	---------

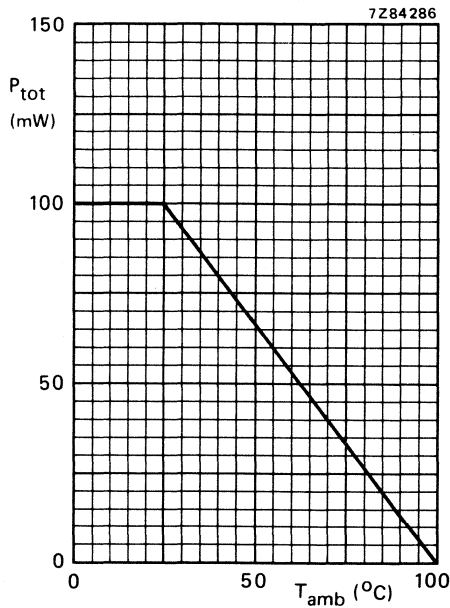

Fig. 2 Power derating curve versus ambient temperature.

CHARACTERISTICS

$T_j = 25\text{ }^\circ\text{C}$

Forward voltage

$I_F = 20\text{ mA}$

V_F	typ.	1,2 V
	max.	1,5 V

Reverse current

$V_R = 5\text{ V}$

I_R	max.	100 μA
-------	------	-------------------

Diode capacitance

$V_R = 0; f = 1\text{ MHz}$

C_d	typ.	40 pF
-------	------	-------

Total radiant power

$I_F = 20\text{ mA}$

CQY58A	ϕ_e	typ.	1 mW
	I_e	min.	2 mW/sr

Radiant intensity (on-axis)

$I_F = 20\text{ mA}$

CQY58A-1	I_e	min.	1 mW/sr
		max.	5 mW/sr

CQY58A-2	I_e	min.	3 mW/sr
-----------------	-------	------	---------

Wavelength at peak emission

λ_p	typ.	930 nm
-------------	------	--------

Bandwidth at half height

$\Delta\lambda$	typ.	50 nm
-----------------	------	-------

Beamwidth between half-intensity directions

$I_F = 20\text{ mA}$

$\theta_{1/2}$	typ.	20 $^\circ$
----------------	------	-------------

Switching times

$I_{Fon} = 20\text{ mA}$

Light rise time

t_r	typ.	3 μs
-------	------	-----------------

Light fall time

t_f	typ.	3 μs
-------	------	-----------------

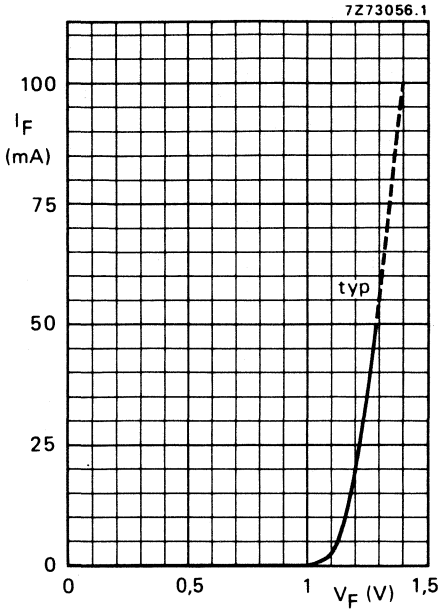

Fig. 3 $T_{amb} = 25\text{ }^\circ\text{C}$.

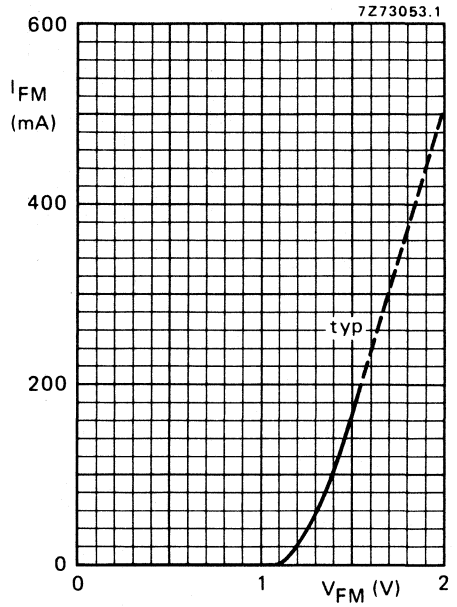

Fig. 4 $t_p = 10\text{ }\mu\text{s}$; $T = 1\text{ ms}$; $T_{amb} = 25\text{ }^\circ\text{C}$.

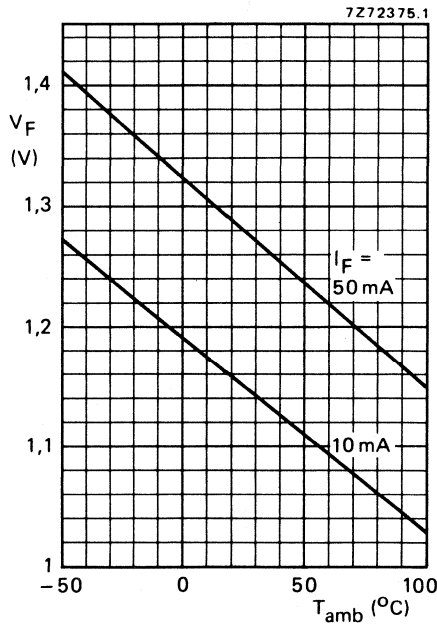

Fig. 5 Typical values.

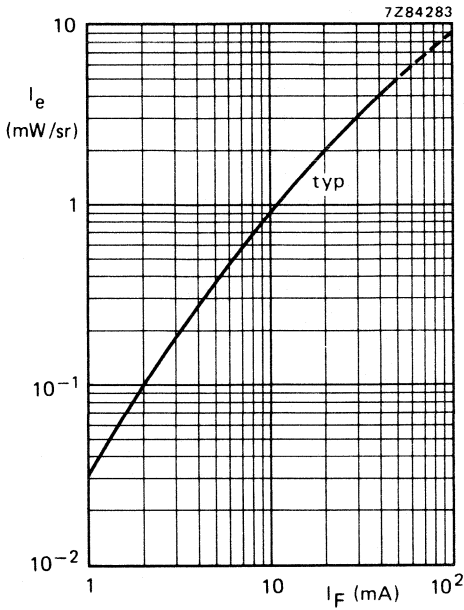

Fig. 6 $T_{amb} = 25^\circ C$.

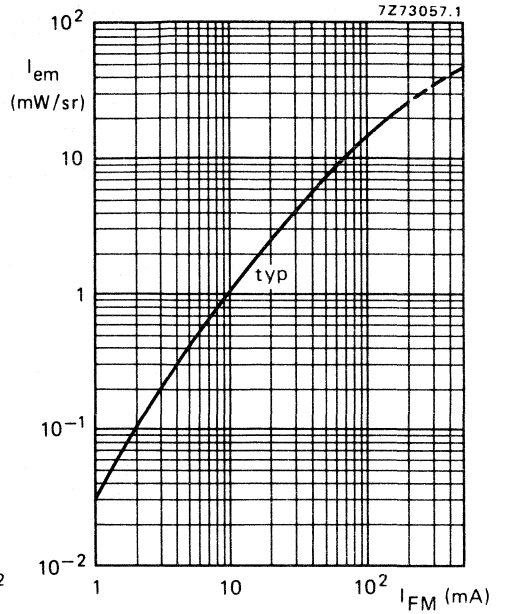

Fig. 7 $t_p = 10 \mu s$; $T = 1 ms$; $T_{amb} = 25^\circ C$.

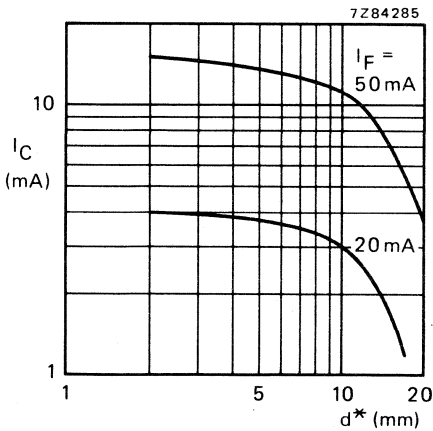

Fig. 8 $V_{CE} = 5 V$; $T_{amb} = 25^\circ C$; typical values.

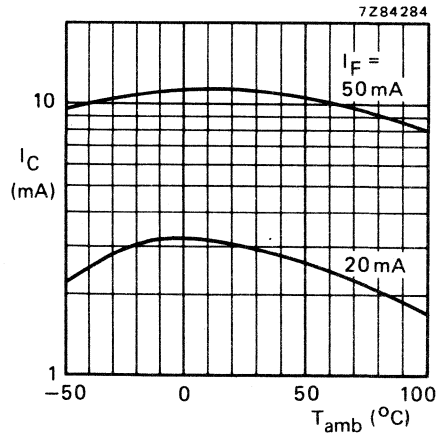

Fig. 9 $V_{CE} = 5 V$; $d^* = 10 mm$; typical values.

* d = shortest free distance of mechanical on-axis when BPW22A is coupled with CQY58A.

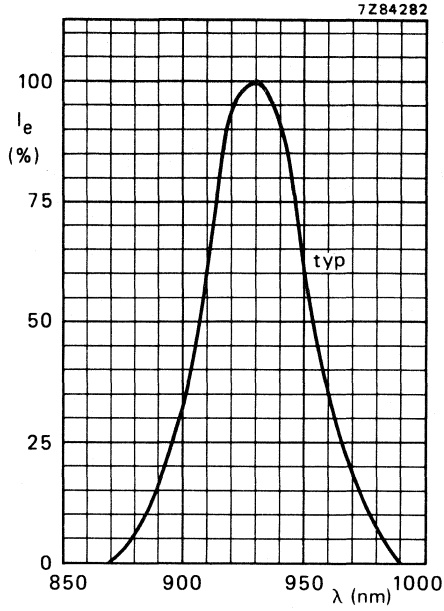

Fig. 10 Spectral response.

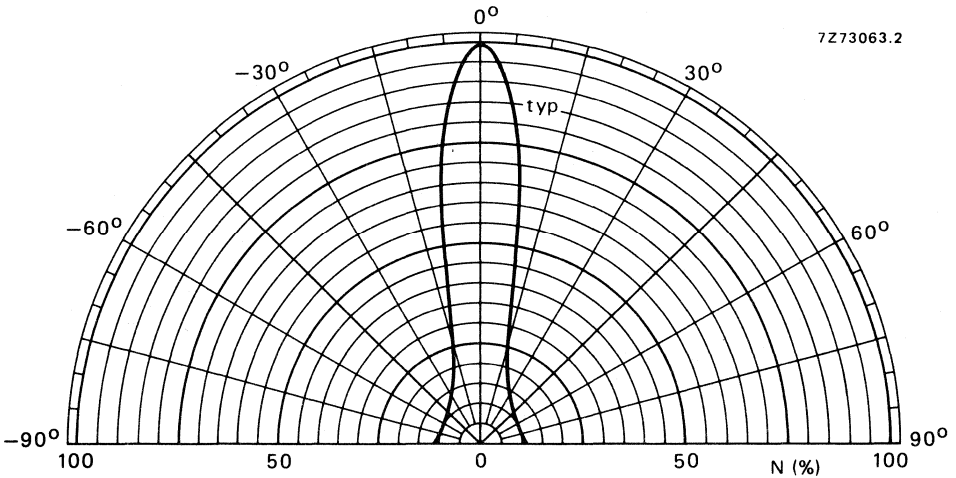

Fig. 11 Typical values.

GaAs LIGHT EMITTING DIODE

Epitaxial gallium arsenide light emitting diode intended for remote-control applications. It emits radiation in the near infrared when forward biased. Infrared translucent epoxy encapsulation (dark blue). Combination with the photo p-i-n diode BPW50 is recommended.

QUICK REFERENCE DATA

Continuous reverse voltage		V_R	max.	5 V
Forward current (d.c.)		I_F	max.	130 mA
Total power dissipation up to $T_{amb} = 25\text{ }^\circ\text{C}$		P_{tot}	max.	215 mW
Junction temperature		T_j	max.	100 $^\circ\text{C}$
Radiant intensity (on-axis) static (at d.c. condition) $I_F = 100\text{ mA}$	CQY89A	I_e	min.	9 mW/sr
	CQY89A-1	I_e	min.	12 mW/sr
	CQY89A-2	I_e	min.	15 mW/sr
dynamic (at pulse condition) $I_{FM} = 100\text{ mA}$; $t_p = 0,5\text{ }\mu\text{s}$; $\delta = 0,5$		I_{eD}	typ.	0,3 I_e
Wavelength at peak emission		λ_p	typ.	930 nm

RATINGS

Limiting values in accordance with the Absolute Maximum System (IEC 134)

Continuous reverse voltage	V_R	max.	5 V
Forward current (d.c.)	I_F	max.	130 mA
Forward current (peak value) $t_p \leq 50 \mu\text{s}; \delta = 0,05$	I_{FM}	max.	1000 mA
Non-repetitive peak forward current ($t_p \leq 10 \mu\text{s}$)	I_{FSM}	max.	2500 mA
Total power dissipation up to $T_{amb} = 25 \text{ }^\circ\text{C}$	P_{tot}	max.	215 mW
Storage temperature	T_{stg}		-55 to + 100 $^\circ\text{C}$
Junction temperature	T_j	max.	100 $^\circ\text{C}$
Lead soldering temperature up to the seating plane; $t_{slid} < 10 \text{ s}$	T_{slid}	max.	260 $^\circ\text{C}$

THERMAL RESISTANCE

From junction to ambient mounted on a printed-circuit board	$R_{th j-a}$	=	350 K/W
--	--------------	---	---------

CHARACTERISTICS $T_j = 25 \text{ }^\circ\text{C}$ unless otherwise specified

Forward voltage $I_F = 100 \text{ mA}$	V_F	typ. <	1,4 V 1,6 V	
$I_{FM} = 1500 \text{ mA}; t_p = 20 \mu\text{s}; \delta = 0,033$	V_{FM}	typ.	2,4 V	
Reverse current $V_R = 5 \text{ V}$	I_R	<	100 μA	
Diode capacitance $V_R = 0; f = 1 \text{ MHz}$	C_d	typ.	40 pF	
Total radiant power $I_F = 100 \text{ mA}$	ϕ_e	> typ.	7 mW 12 mW	
Decrease of radiant power with temperature $I_F = 100 \text{ mA}$	$\frac{\Delta\phi_e}{\Delta T_j}$	typ.	1 %/K	
Radiant intensity (on-axis) static (at d.c. condition) $I_F = 100 \text{ mA}$	CQY89A CQY89A-1 CQY89A-2	I_e I_e I_e	min. min. min.	9 mW/sr 12 mW/sr 15 mW/sr
dynamic (at pulse condition)* $I_{FM} = 100 \text{ mA}; t_p = 0,5 \mu\text{s}; \delta = 0,5$	I_{eD}	typ.	0,3 I_e	

* I_{eD} = Dynamic radiant intensity (average radiant intensity level during pulse time).

Wavelength at peak emission

$I_F = 100 \text{ mA}$

λ_p typ. 930 nm

Bandwidth at half height

$I_F = 100 \text{ mA}$

$\Delta\lambda$ typ. 50 nm

Beamwidth between half-intensity directions

$I_F = 100 \text{ mA}$

$\theta_{1/2}$ typ. 40 °

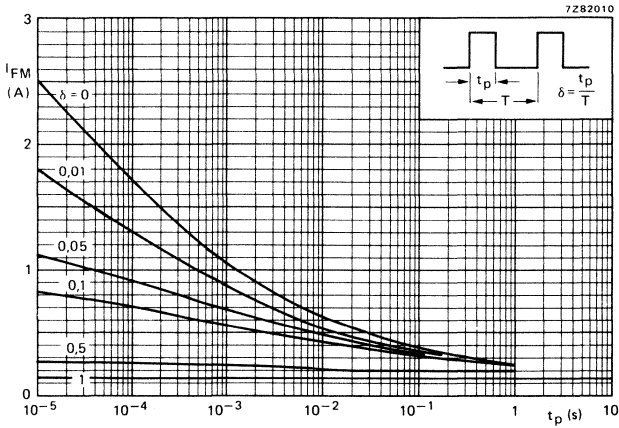

Fig. 2 $T_{amb} = 25 \text{ }^\circ\text{C}$; $T_j \text{ peak} = 100 \text{ }^\circ\text{C}$.

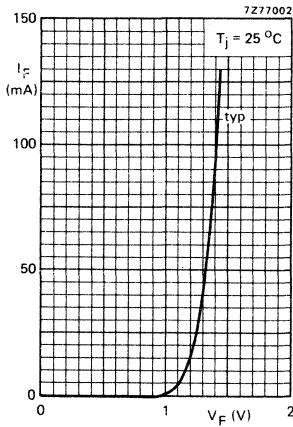

Fig. 3.

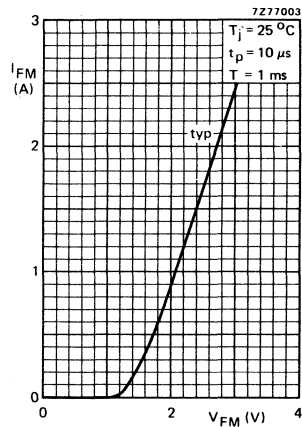

Fig. 4.

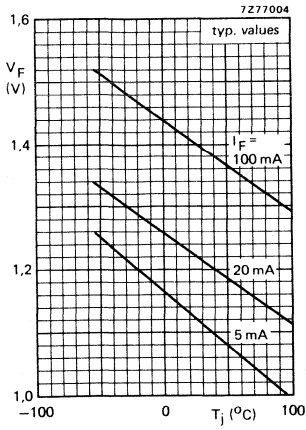

Fig. 5.

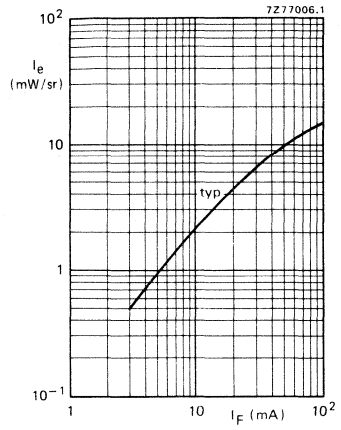

Fig. 6 $T_j = 25 \text{ }^{\circ}\text{C}$.

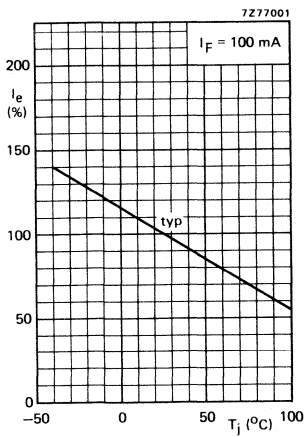

Fig. 7.

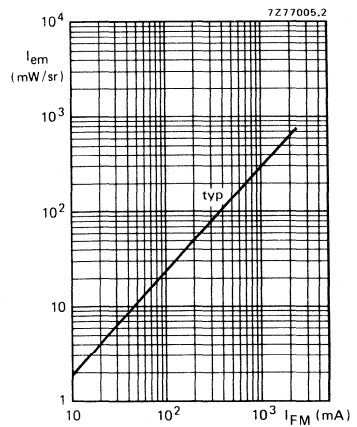

Fig. 8 $T_{amb} = 25 \text{ }^{\circ}\text{C}$; $t_p = 10 \text{ } \mu\text{s}$; $T = 1 \text{ ms}$.

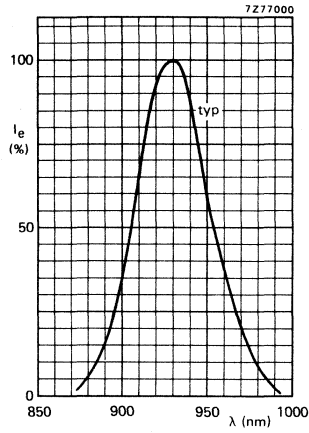

Fig. 9.

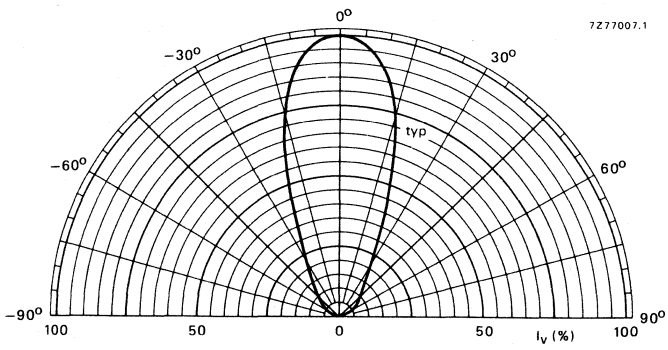

Fig. 10.

SECTION C1

Laser and fibre-optic components

SAFE OPERATION AND HANDLING OF LASER-DIODES

In the past, semiconductor laser-diodes have always been regarded as some of the more expensive semiconductor components. High cost restricted their use to professional and military applications, and even the use of laser-diodes in fibre-optic communications didn't lead to the expected price reduction. It has been the demand for laser diodes in compact disc players and Laservision systems that has stimulated large scale production with the result that these devices are readily available at low cost. Consequently, new applications, which were not previously economically worthwhile (such as bar code readers, distance and speed measurements etc.), are continually evolving and more companies than ever before are dealing with lasers for the first time. For all applications, the laser beam must be collimated and properly focused. It is therefore necessary to emphasise the dangers involved and the special requirements for handling lasers.

HANDLING RECOMMENDATIONS

Our laser-diodes are high quality devices. Handled correctly they are very reliable:

- Laser-diodes are extremely sensitive to electrostatic discharges. Always short-circuit the anode to the cathode when the diode is not in use. In addition, we recommend that persons handling the laser should be earthed, as well as their tools.
- Keep the laser-diode clean, both in use and in storage. This is particularly important for the light-emitting aperture.

OPERATING RECOMMENDATIONS

Once connected into the circuit, a laser diode can be damaged by:

- Transient current pulses and excessive currents. Electrically, the laser-diode is a reliable device and can tolerate substantial current surges, but optically, it is more easily damaged because of the extremely high flux passing through both facets, while in operation. To prevent gradual or instantaneous damage, the laser should be carefully controlled when it is switched on and off. You should also ensure that peak and mean power supply levels, radiant flux and forward current do not exceed the maximum ratings.
- High temperatures, which reduce device reliability and shorten lifetimes. We recommend using a heatsink and, as mentioned previously, carefully controlling the power supply. We also suggest you operate the laser-diode at the lowest temperature possible.

SAFETY RECOMMENDATIONS

The light from a semiconductor laser has a number of potential health risks associated with it. Because of material constraints, the light produced usually has a wavelength in the invisible infrared region that is of sufficient intensity to damage the retina. So take care to avoid looking directly at the light close to the source, especially with collimated beams, and avoid the optical axis at greater distances. You should also ensure there are no surfaces which can accidentally reflect the light. All laser-diode packages carry a warning label and the diodes fall within safety class 3B of the international standard code.

SILICON PHOTODIODE FOR FIBRE-OPTIC COMMUNICATIONS

Photo p-i-n diode in hermetic TO-46 encapsulation, designed for fibre-optic transmissions over short and medium distances, mainly for military and industrial applications.

It is optimized to be coupled with a 200 μm core diameter fibre and to be used in combination with the CQF24 emitter.

The crystal is electrically isolated from the case.

QUICK REFERENCE DATA

Continuous reverse voltage	V_R	max.	50 V
Dark reverse current at $V_R = 15\text{ V}$	$I_{R(D)}$	max.	0,8 nA
Total power dissipation up to $T_{\text{amb}} = 25\text{ }^\circ\text{C}$	P_{tot}	max.	100 mW
Diode capacitance at $V_R = 15\text{ V}$	C_d	max.	2,5 pF
Spectral sensitivity at $V_R = 15\text{ V}$; $\lambda = 850\text{ nm}$	s_λ	min.	0,4 A/W

MECHANICAL DATA

Dimensions in mm

Fig. 1.

Pinning:

- 1 = anode
- 2 = cathode
- 3 = case

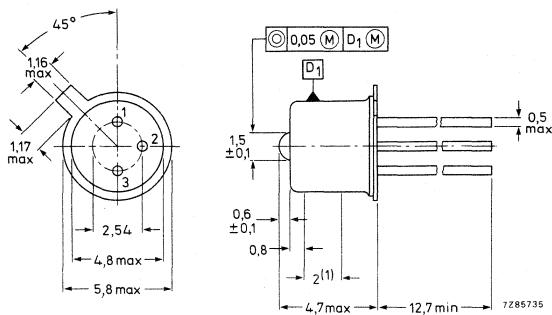

(1) Case diameter over this length is 4,7 (+0,05; -0,1) mm.

RATINGS

Limiting values in accordance with the Absolute Maximum System (IEC 134)

→ Continuous reverse voltage	V_R	max.	50 V
Total power dissipation up to $T_{amb} = 25\text{ }^\circ\text{C}$	P_{tot}	max.	100 mW
Junction temperature	T_j	max.	150 $^\circ\text{C}$
Operating temperature	T_{op}	-55 to +125	$^\circ\text{C}$
Storage temperature	T_{stg}	-65 to +150	$^\circ\text{C}$

THERMAL RESISTANCE

From junction to ambient when the device is mounted on a printed circuit	$R_{th\ j-a}$	typ.	400 K/W
		max.	500 K/W
From junction to case	$R_{th\ j-c}$	typ.	100 K/W
		max.	150 K/W

CHARACTERISTICS

$T_{amb} = 25\text{ }^\circ\text{C}$ unless otherwise specified

Dark reverse current at $V_R = 15\text{ V}$	$I_{R(D)}$	max.	0,8 nA
Spectral sensitivity at $V_R = 15\text{ V}; \lambda = 850\text{ nm}$	s_λ	min.	0,4 A/W
		typ.	0,55 A/W
Wavelength at peak response	λ_p	typ.	850 nm
Diode capacitance at $V_R = 10\text{ V}$	C_d	typ.	1,5 pF
		max.	2,5 pF
Switching times at $V_R = 10\text{ V}; R_L = 50\text{ }\Omega$ (10%-90%)	t_r	max.	4 ns
	t_f	max.	4 ns

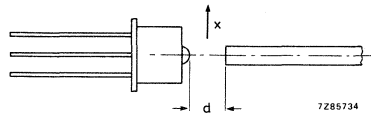

Fig. 2 Distance d and lateral displacement x.

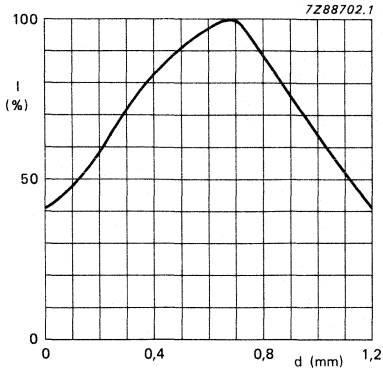

Fig. 3.

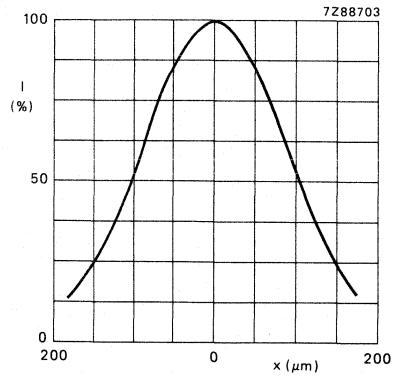

Fig. 4.

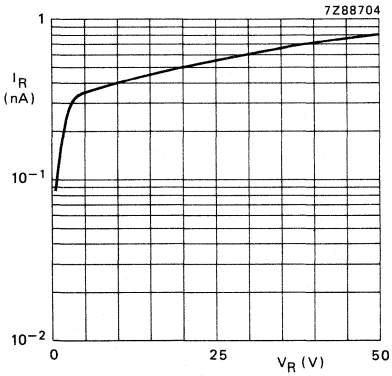

Fig. 5 $T_{amb} = 25\text{ }^{\circ}\text{C}$.

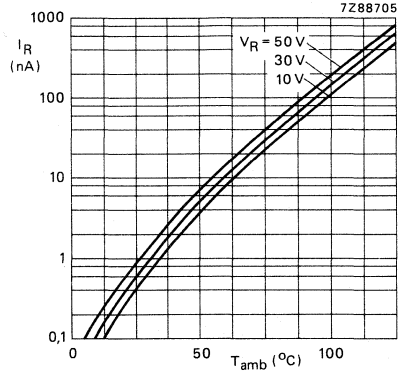

Fig. 6.

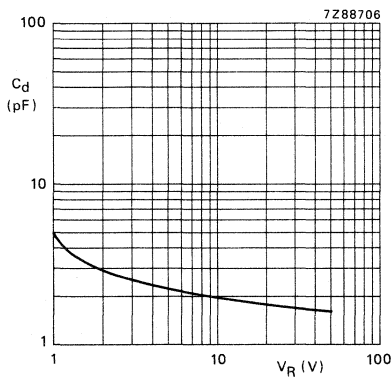

Fig. 7 $f = 1\text{ MHz}$; $T_{amb} = 25\text{ }^{\circ}\text{C}$.

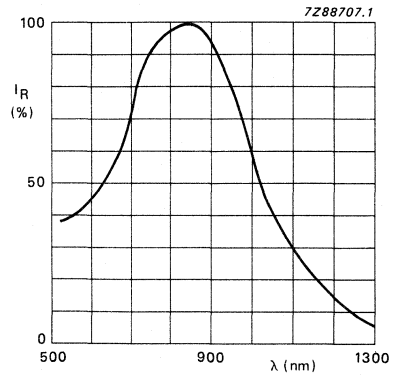

Fig. 8 $V_R = 10\text{ V}$; $T_{amb} = 25\text{ }^{\circ}\text{C}$.

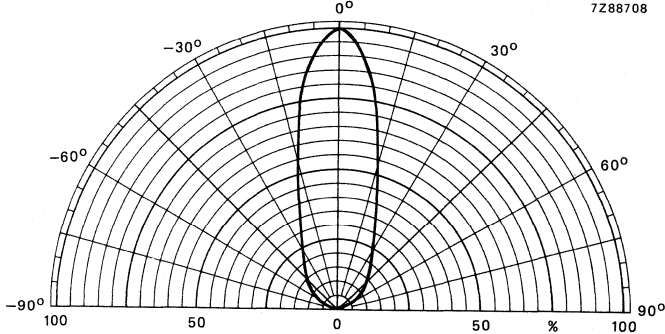

Fig. 9.

GaAlAs LIGHT EMITTING DIODE

Infrared light emitting diode in hermetic TO-46 encapsulation, designed for fibre-optic transmissions over short and medium distances, mainly for military and industrial applications.

It is optimized to be coupled with a 200 μm core diameter fibre and to be used in combination with the BPF24 receiver.

The crystal is electrically isolated from the case.

QUICK REFERENCE DATA

Continuous reverse voltage	V_R	max.	3 V
Forward current (d.c.)	I_F	max.	100 mA
Total power dissipation up to $T_{\text{amb}} = 25^\circ\text{C}$	P_{tot}	max.	250 mW
Optical power coupled into fibre (ϕ core = 200 μm and $\text{NA} = 0,2$) at $I_F = 100 \text{ mA}$	ϕ_e	min.	200 μW
Switching times at $I_F = 100 \text{ mA}$	t_r	typ.	10 ns
	t_f	typ.	10 ns
Wavelength at peak emission	λ_p	typ.	850 nm

MECHANICAL DATA

Dimensions in mm

Fig. 1.

Pinning:
1 = anode
2 = cathode
3 = case

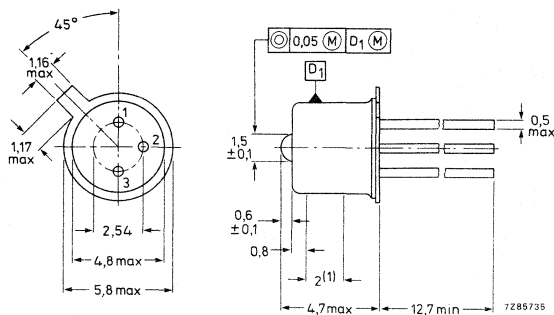

(1) Case diameter over this length is 4,7 (+ 0,05; -0,1) mm.

RATINGS

Limiting values in accordance with the Absolute Maximum System (IEC 134)

Continuous reverse voltage	V_R	max.	3 V
Forward current	I_F	max.	100 mA
Forward current (peak) $t = 10 \mu\text{s}; \delta = 0,1$	I_{FM}	max.	300 mA
Total power dissipation up to $T_{amb} = 25 \text{ }^\circ\text{C}$ device mounted on a printed circuit	P_{tot}	max.	250 mW
Junction temperature	T_j	max.	150 $^\circ\text{C}$
Operating temperature	T_{op}		-55 to +125 $^\circ\text{C}$
Storage temperature	T_{stg}		-65 to +150 $^\circ\text{C}$

THERMAL RESISTANCE

From junction to ambient when the device is mounted on a printed circuit

R_{thj-a}	typ.	400 K/W
	max.	500 K/W

From junction to case

R_{thj-c}	typ.	100 K/W
	max.	150 K/W

CHARACTERISTICS $T_{amb} = 25 \text{ }^\circ\text{C}$ unless otherwise specifiedForward voltage
at $I_F = 100 \text{ mA}$

V_F	typ.	1,9 V
	max.	2,5 V

Reverse current
at $V_R = 3 \text{ V}$

I_R	max.	100 μA
-------	------	-------------------

Radiant power coupled into fibre

at $I_F = 100 \text{ mA}$ $\phi_{\text{core}} = 200 \mu\text{m}$,

NA = 0,2

} see notes 1 and 2

ϕ_e	min.	200 μW
	typ.	400 μW

Radiant intensity
at $I_F = 100 \text{ mA}$

I_e	min.	5 mW/sr
-------	------	---------

→ Wavelength at peak emission

λ_p	min.	820 nm
	typ.	850 nm
	max.	880 nm

Spectral width at half height

$\Delta\lambda$	typ.	40 nm
-----------------	------	-------

Switching times

at $I_{Fon} = 100 \text{ mA}$

t_r	typ.	10 ns
	max.	15 ns

t_f	typ.	10 ns
	max.	15 ns

NOTES

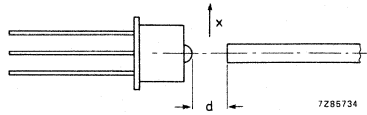
Fig. 2 Distance d and lateral displacement x .

1. For this measurement the device is shifted along its 3 axes, so that the maximum power is coupled into the fibre.

If the device is adjusted in front of the geometrical axis of the same fibre with distance $d = 0,7 \text{ mm}$, $P_{\text{min}} = 100 \mu\text{W}$.

2. For a different core diameter $\phi_x \leq 200 \mu\text{m}$:
$$\frac{P_{\text{inj}}(x)}{P_{\text{inj}}(200)} = \left(\frac{\phi_x}{200}\right)^2$$

For a different numerical aperture $NA_x \leq 0,2$:
$$\frac{P_{\text{inj}}(x)}{P_{\text{inj}}(0,2)} = \left(\frac{NA_x}{0,2}\right)^2$$

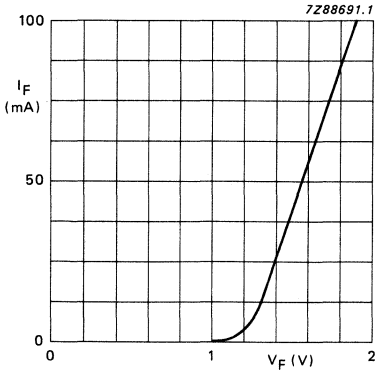

Fig. 3 $T_{amb} = 25\text{ }^{\circ}\text{C}$.

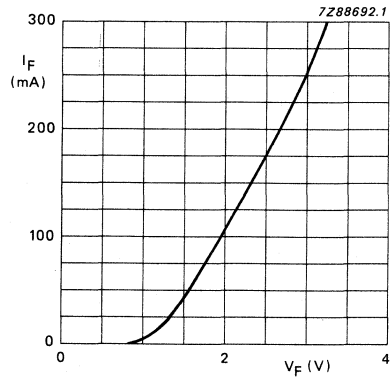

Fig. 4 $T_{amb} = 25\text{ }^{\circ}\text{C}$; $T_{on} = 10\text{ }\mu\text{s}$; $\delta = 0,1$.

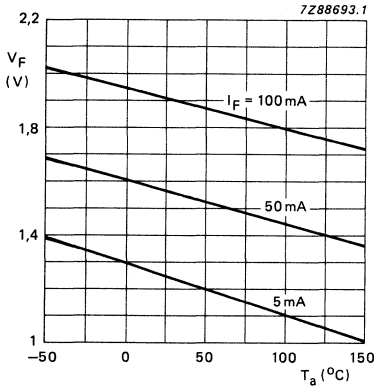

Fig. 5.

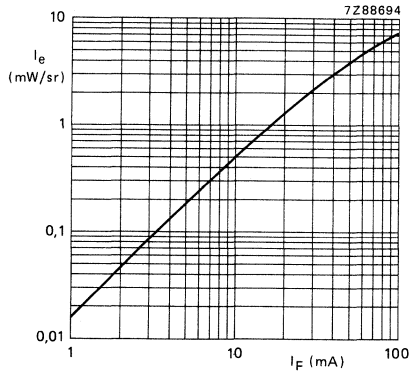

Fig. 6 $T_{amb} = 25\text{ }^{\circ}\text{C}$.

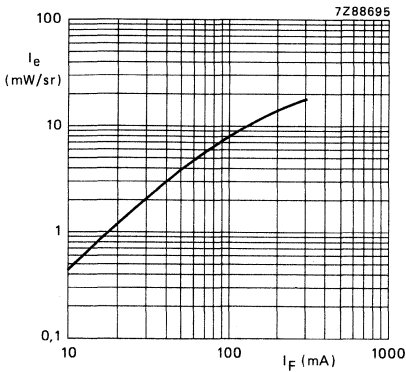

Fig. 7 $T_{amb} = 25\text{ }^{\circ}\text{C}$; $T_{on} = 10\text{ }\mu\text{s}$; $\delta = 0,01$.

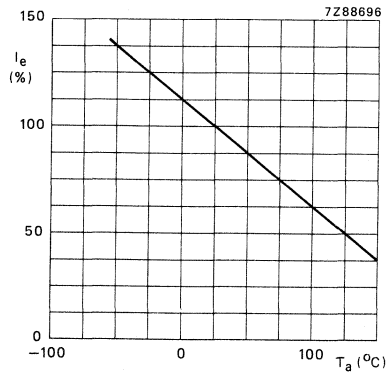

Fig. 8.

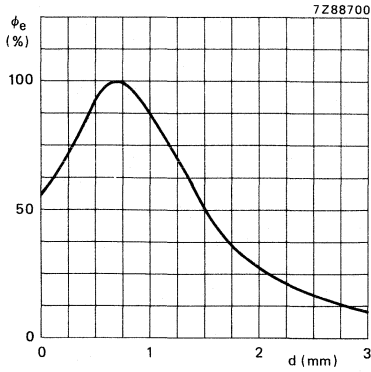

Fig. 9 See notes 1 and 2.

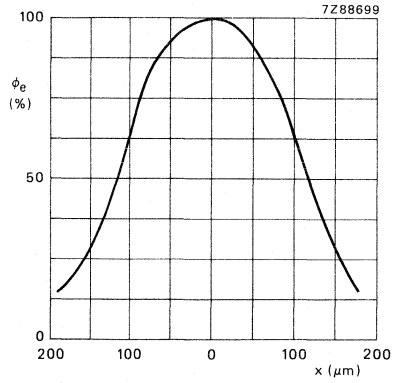

Fig. 10 Distance $d = 700 \mu\text{m}$.
See notes 1 and 2.

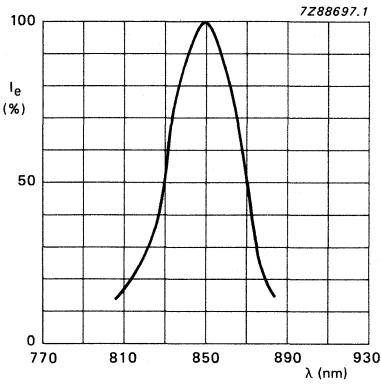

Fig. 11 $I_F = 100 \text{ mA}$; $T_{\text{amb}} = 25 \text{ }^\circ\text{C}$.

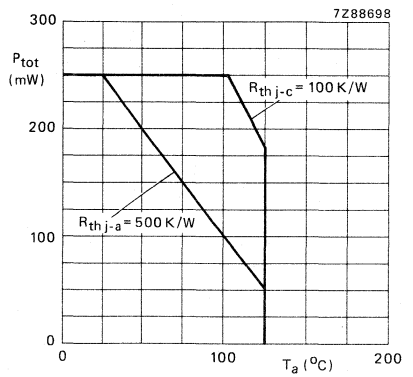

Fig. 12.

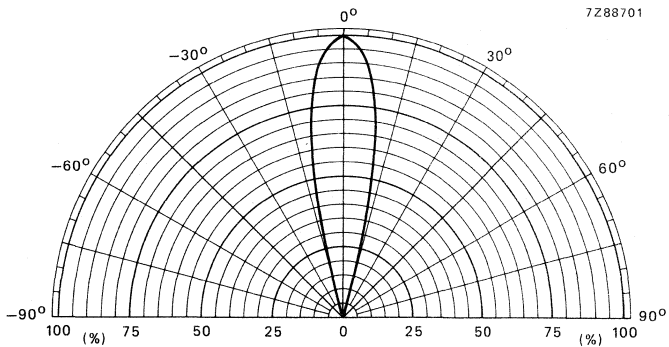

Fig. 13.

DOUBLE HETEROSTRUCTURE AlGaAs LASER

The CQL10A is designed for reading applications such as: video-audio disc applications, optical memories, security systems, etc.

This device is mounted in an hermetic SOT-148 encapsulation specifically designed for easy alignment in an optical read or write system. The copper heatsink is circular and precision engineered with a diameter accuracy of $+0, -9 \mu\text{m}$. Laser-stripe and mechanical axis coincide within $50 \mu\text{m}$.

The CQL10A is standard equipped with a photo p-i-n diode, optically coupled to the rear emitting facet of the laser. This fast responding (less than 20 ns) photodiode can be used as a sensor to control the laser radiant output level. The ultra-flat top window (flat within two fringes) guarantees an unperturbed beam wavefront.

QUICK REFERENCE DATA

Threshold current at $T_c = 30 \text{ }^\circ\text{C}$	I_{th}	typ.	65 mA
C.W. radiant output power up to $T_c = 60 \text{ }^\circ\text{C}$	ϕ_e	typ.	5 mW
Wavelength at peak emission	λ_p	typ.	820 nm

MECHANICAL DATA

Fig. 1 SOT-148.

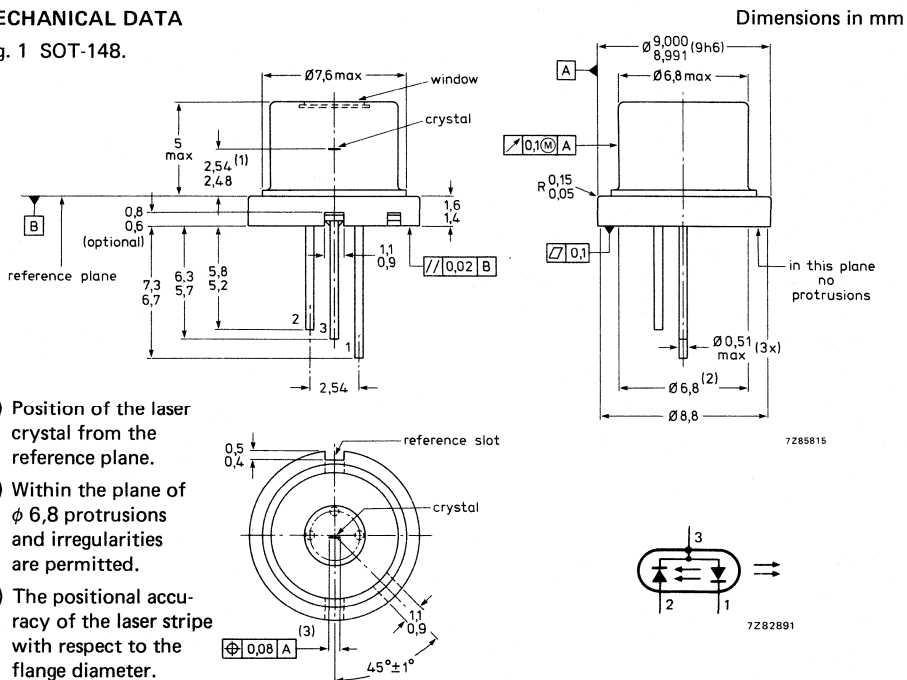

LASER

The double heterostructure stripe laser operates in single transverse, multiple longitudinal mode (TE_{00}) over the full power range. The structure is designed to operate C.W. 5 mW up to relatively high temperatures (60 °C case temperature) and a wavelength of 820 nm which makes reading standard Video Long Play records and compact discs (DAD) a possible application.

RATINGS

Limiting values in accordance with the Absolute Maximum System (IEC 134)

Radiant output power	ϕ_e	max.	10 mW
Reverse voltage	V_R	max.	1 V
Temperatures (<i>both laser and photodiode</i>)			
C.W. operation	T_C	-20 to +60 °C	
storage	T_{stg}	-55 to +100 °C	

CHARACTERISTICS

Threshold current			
at $T_C = 30\text{ °C}$	I_{th}	typ.	65 mA
at $T_C = 60\text{ °C}$			90 mA
Operating current			
$\phi_e = 5\text{ mW}; T_C = 30\text{ °C}$	I_{op}	typ.	85 mA
		max.	120 mA
$\phi_e = 5\text{ mW}; T_C = 60\text{ °C}$	I_{op}	typ.	120 mA
		max.	160 mA
Recommended operating radiant output power			
up to $T_C = 60\text{ °C}$	ϕ_e	typ.	5 mW
Forward voltage drop up to $T_C = 60\text{ °C}$			
$\phi_e = 5\text{ mW}$	V_F	typ.	2,5 V
Wavelength at peak emission			
$\phi_e = 5\text{ mW}; T_C = 30\text{ °C}$	λ_p	typ.	820 nm
Spectral width at half height			
$\phi_e = 5\text{ mW}$	$\Delta\lambda$	typ.	4 nm
Far-field angle at half-intensity directions (FWHM)			
perpendicular to the junction plane	$\alpha_{50\%(\perp)}$	typ.	50 °
parallel to the junction plane	$\alpha_{50\%()}$	typ.	35 °
Near-field width at half-intensity directions (FWHM)	$\delta_{50\%}$	typ.	6-7 μm
Astigmatism (distance between focal lines)	A_D	typ.	15 μm
Series resistance	R_S	typ.	5 Ω
Differential efficiency at $\phi_e = 2\text{ mW}$	ϵ	typ.	0,15 W/A
Spontaneous emission at I_{th}	ϕ_{spon}	typ.	0,5 mW
Turn-on/turn-off time (above threshold)	t_{on}/t_{off}	typ.	1 ns
Degradation rate			
$T_C = 60\text{ °C}; \phi_e = 5\text{ mW}$	$\frac{1}{I_{op}} \cdot \frac{dI_{op}}{dT}$	typ.	5 %/K
Temperature coefficient of wavelength	$\frac{d\lambda_{pk}}{dT}$	typ.	0,25 nm/K
Temperature coefficient of I_{th}	$\frac{I}{I_{th}} \cdot \frac{dI_{th}}{dT}$	typ.	1 %/K
Thermal resistance			
from junction to case	$R_{th\text{ j-c}}$	typ.	50 K/W

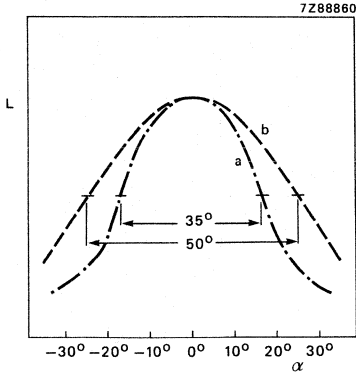

Fig. 2 Far-field pattern.
 a. parallel to the junction plane.
 b. perpendicular to the junction plane.

PHOTODIODE

RATINGS

Limiting values in accordance with the Absolute Maximum System (IEC 134)

Reverse voltage V_R max. 30 V

CHARACTERISTICS

Luminous sensitivity at $V_R = 15$ V

N typ. 0,5 A/W

Dark reverse current at $V_R = 15$ V

$I_{R(D)}$ max. 10 nA

Capacitance at $V_R = 0$

C_d max. 5 pF

Monitor diode current at $V_R = 15$ V

$I_{R(L)}$ 150-400 μ A/mW

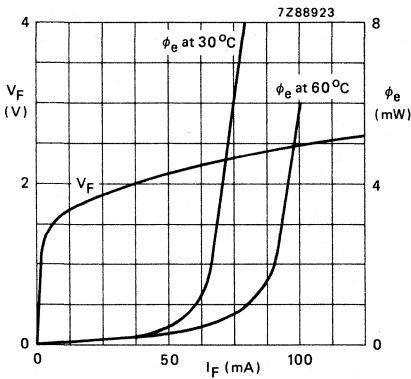

Fig. 3 Forward voltage drop (V_F) and radiant output power (ϕ_e) of laser diode as a function of forward current; typ. values.

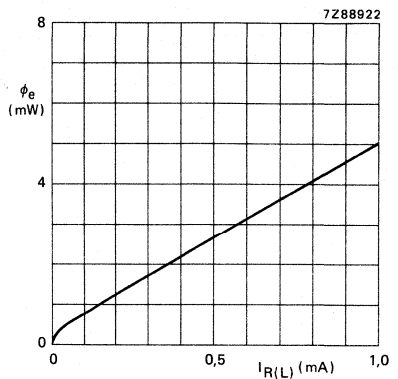
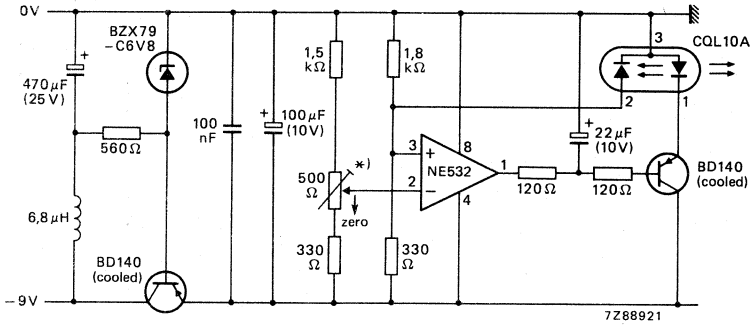

Fig. 4 Radiant output power (ϕ_e) as a function of monitor current of photodiode; V_R (photodiode) = 15 V; typ. values.



* Ten-turn. Zero position is at 0,58 revolution. Each revolution is equivalent to 500 μA monitor diode current. Adjust from zero position.

Fig. 5 Recommended control circuit for continuous operation.

OPERATING PRECAUTIONS

Semiconductor lasers in general are easily damaged by overdriving and electrical transients. Electrically, the laser diode is a very reliable device and can easily withstand current surges of several amperes. Optically, however, the laser diode is more susceptible to damage because of the extremely high optical flux density passing through both facets, while in operation. By overdriving or transients to the laser, even for pulses in the nanosecond region, the optical flux density can rise to unacceptable values (10 to 100 MW/cm²), causing gradual or catastrophic degradation of the laser facets. Current transients should therefore be carefully avoided; they can substantially decrease the laser life time.

CAUTION

Aluminium gallium arsenide lasers emit radiation which is invisible to the human eye. When in use, do not look directly into the device. Direct viewing of laser light at close ranges, especially in conjunction with collimating lenses, may cause eye damage.

The device falls within safety class 3B of the international standard code.

COLLIMATOR PEN

The collimator pen CQL13A is used for reading applications such as: data retrieval, video-audio disc applications, optical memories, security systems etc.

The pen is mounted in a non-hermetic encapsulation, specifically designed for easy alignment in an optical read or write system, and consists of a lens system and a laser device. The lens system collimates the diverging laser light. The wavefront quality is diffraction limited. A cylindrical lens is used for correction of the astigmatism of the laser.

The housing is circular and precision manufactured with a diameter accuracy between + 0 and -11 μm .

QUICK REFERENCE DATA

Output power ϕ_e	2 mW
Current at output power $\phi_e = 2$ mW and temperature of 60 °C	< 175 mA
Wavelength at peak emission λ_p	typ. 820 nm
Wavefront form of bundle (non-convergent) divergence	< 0,3 mrad

MECHANICAL DATA

Dimensions in mm

Fig. 1.

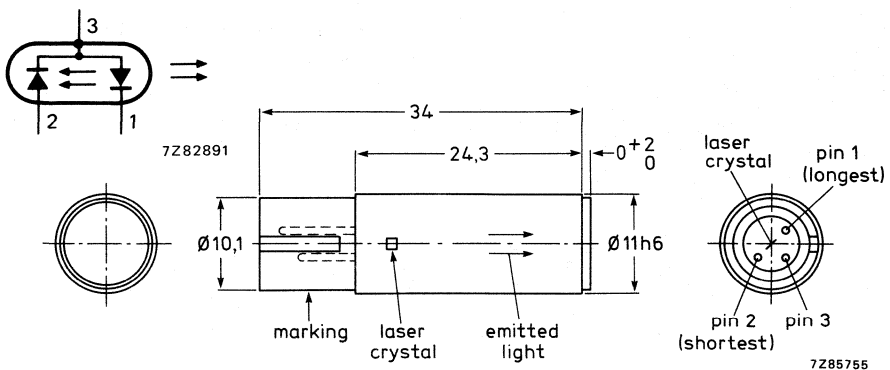

Mass	max. 8 g
Concentricity	angle between the mechanical and optical axis ≤ 10 mrad
Marking	type number CQL13A and serial number
Mounting	on a p.c. board by means of a specifically designed connector
Accessories	the pen is supplied with a connector
WARNING	THE LASER AND CONSEQUENTLY THE COLLIMATOR PEN HAS POSITIVE POLARITY ON THE CASE.

CHARACTERISTICS

Measuring conditions

- Climatological relative humidity 5–90%, atmospheric pressure. Housing temperature of the pen 5–60 °C
- Electrical d.c. operation, optical feedback drive and protection against transients
- Optical only the radiation in a bundle with a diameter of 5,4 mm is relevant

Optical data

Output power	ϕ_e	max. 2 mW (see Fig. 4)
Spectral		
wavelength	λ	820 ± 10 nm
bandwidth	$\Delta\lambda$	< 4 nm (see note)
wavelength drift	$\Delta\lambda/\Delta T$	approx. 0,25 nm/K
Bundle properties		
dimension		ϕ 5,4 mm
wavefront form		plane, non-convergent divergence < 0,3 mrad
aberrations		variance of wavefront with respect to the Gaussian reference sphere is less than $\lambda^2/300$
polarization		plane
polarization ratio		typ. 35 : 1
Intensity distribution		
transversal mode		TE ₀₀ -fundamental
longitudinal mode		see note
symmetry		variation of optical power in the four quadrants (see Fig. 2) typ. 20%
ripple		local value of the intensity < 15% of the smooth value
filling ratio I_{rim}/I_{max}		> 0,17

Note: the number of longitudinal modes is related to the spectral width.

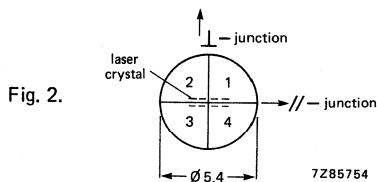

Fig. 2.

Electrical data

- Current
 - at $\phi_e = 2$ mW and $T_h = 60$ °C ≤ 175 mA
- Drive voltage $V_D \leq 5$ V
- Resistance between collimator pen and connector at 10 mA, max. 20 mV_{pp} and 1 kHz ≤ 12 m Ω

PHOTODIODE (see Fig. 5)

RATINGS

Reverse voltage $V_R \leq 30 \text{ V}$

CHARACTERISTICS

Monitor diode sensitivity (ratio of photodiode current to optical power emitted by collimator pen)
at $\phi_e = 2 \text{ mW}$ 0,1 A/W

Dark reverse current
at $V_R = 15 \text{ V}$ $I_{R(D)} < 10 \text{ nA}$

Capacitance
at $V_R = 0$ $C_d < 5 \text{ pF}$

ENVIRONMENTAL TESTS

The device meets all specifications mentioned below 2 hours after each test. During these tests the collimator pen is not operating.

test	in accordance with	conditions
Rapid change of temperature	IEC 68-2-14, test Na	-25 °C to 25 °C to 70 °C to 25 °C; duration of each exposure 30 min and 10 cycles in total
Dry heat	IEC 68-2-2, test Bc	Temperature: 70 °C Duration: 7 days
Cold	IEC 68-2-1 test Aa	Temperature: -25 °C Duration: 7 days
Damp heat, steady state	IEC 68-2-3 test Ca	Temperature: 40 °C Relative humidity (R.H.): 90–95% Duration: 42 days
Damp heat, cyclic	IEC 68-2-30 test Db	Temperature/R.H. 45 °C/100% (12 h) to 25 °C/ 85% (12 h) Duration of one cycle: 24 hours Number of cycles: 42
Vibration	IEC 68-2-6 test Db	Frequency range: 10–55 Hz Amplitude: 0,75 mm Duration: 6 hours (2 h in each of directions)
Shock	IEC 68-2-27 test Ea	Pulse shape: half-sine Pulse duration: 11 ms Peak acceleration: 981 m/s ² Number of shocks: 10 in each of 3 directions
Bump	IEC 68-2-29 test Eb	Pulse duration: 6 ms Peak acceleration: 390 m/s ² Number of bumps: 1000 Axes of direction: 6

Cleaning test

The cylinder lens at the side of the long conjugate is cleaned 100x with a small piece of cotton wool, soaked in a 45–95% solution of ethyl-alcohol in water, attached to the end of a small stick.

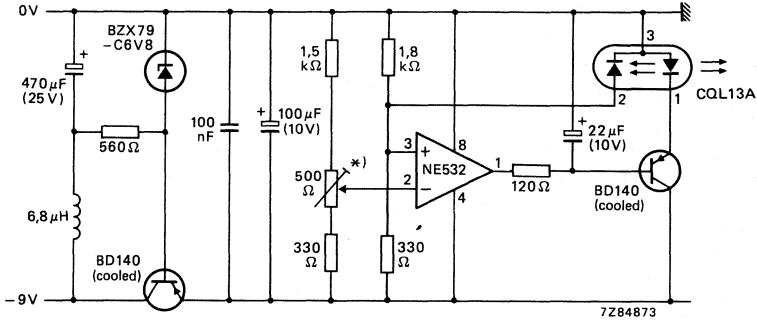

* Ten-turn. Zero position is at 0,58 revolution. Each revolution is equivalent to 500 μA monitor diode current.

Fig. 3 Recommended control circuit.

OPERATING PRECAUTIONS

Semiconductor lasers in general are easily damaged by overdriving and transients. Electrically, the laser diode is a very reliable device and can easily withstand current surges of several amperes. Optically, however, the diode laser is more susceptible to damage because of the extremely high optical flux density passing through both facets, while in operation. By overdriving or transients to the laser, even for pulses in the nanosecond region, the optical flux density can rise to unacceptable values (10 to 100 MW/cm²), causing gradual or catastrophic degradation of the laser facets. Current transients should therefore be carefully avoided; they decrease the laser life time.

CAUTION

Aluminium gallium arsenide lasers emit radiation which is invisible to the human eye. When in use, do not look directly into the device. Direct viewing of laser light at close ranges, especially in conjunction with collimating lenses, may cause eye damage.

The device meets the requirements of safety class 3B of the international standard code.

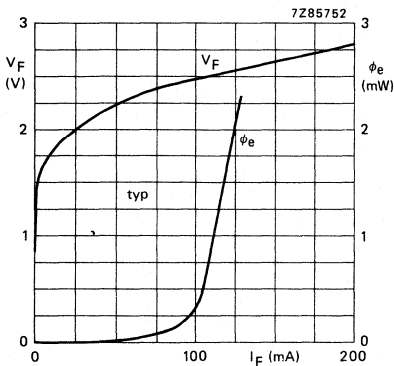

Fig. 4 T_h = 60 °C.

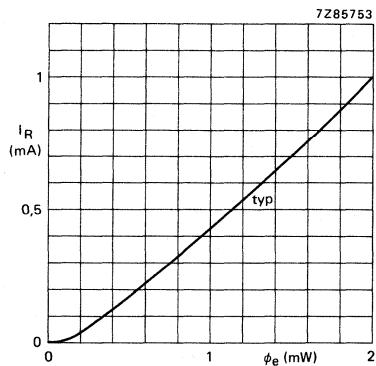

Fig. 5 V_R = 15 V.

DEVELOPMENT DATA

This data sheet contains advance information and specifications are subject to change without notice.

CQL16

COLLIMATOR PEN

The collimator pen CQL16 is used as a laser source in measuring equipment such as telemetry, leveller and security systems.

The pen is mounted in a non-hermetic encapsulation, specifically designed for easy alignment in an optical read or write system, and consists of a lens system and a laser device. The lens system collimates the diverging laser light. The wavefront quality is diffraction limited.

The housing is circular and precision manufactured with a diameter accuracy between +0 and -11 μm.

QUICK REFERENCE DATA

Output power	ϕ_e	max.	2 mW
Current at $\phi_e = 2$ mW and $T_h = 60$ °C	I	max.	100 mA
Wavelength at peak emission	λ_p	typ.	780 nm
Wavefront form of bundle (non-convergent) divergence		max.	0,3 mrad

MECHANICAL DATA

Dimensions in mm

Fig. 1.

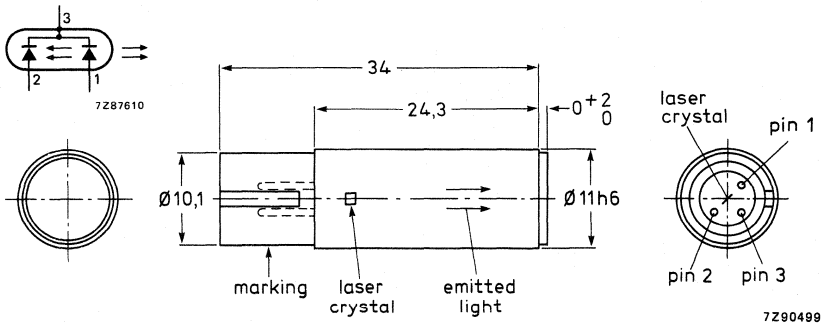

Mass	max. 8 g
Concentricity	angle between the mechanical and optical axis ≤ 10 mrad
Marking	type number CQL16 and serial number
Mounting	on a p.c. board by means of a specifically designed connector
Accessories	the pen is supplied with a connector
WARNING	THE LASER, AND CONSEQUENTLY THE COLLIMATOR PEN, HAS NEGATIVE POLARITY ON THE CASE. The LASER is protected by an antistatic spring which shall NOT be removed before the pen is installed in the connector.

CHARACTERISTICS

Measuring conditions

Climatological	relative humidity 5-90%, atmospheric pressure. Housing temperature of the pen 5-60 °C
Electrical	d.c. operation, optical feedback drive and protection against transients
Optical	only the radiation in a stripe with dimensions 5,4 mm x 3 mm is relevant

Optical data

Output power	ϕ_e	max. 2 mW
Spectral		
wavelength	λ	780 ± 10 nm
bandwidth	$\Delta\lambda$	< 2 nm
wavelength drift	$\Delta\lambda/\Delta T$	approx. 0,25 nm/K
Bundle properties		
dimensions		stripe 5,4 mm x 3 mm, FWHM*
wavefront form		plane, non-convergent, divergence < 0,3 mrad
aberrations		variance of wavefront with respect to the Gaussian reference sphere is less than $\lambda^2/300$
polarization		plane
polarization ratio		typ. 60 : 1
Intensity distribution		
transversal mode		TE ₀₀ -fundamental
symmetry		spot width \perp to junction 5,4 mm spot width \parallel to junction 3,0 mm, FWHM*

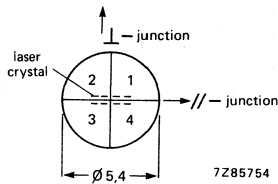

Electrical data

Current			
at $\phi_e = 2$ mW and $T_h = 60$ °C	I	\leq	100 mA
Drive voltage	V_d	\leq	5 V
Resistance between collimator pen and connector at 10 mA, max. 20 mV _{pp} and 1 kHz		\leq	12 m Ω

* FWHM means full width half maximum.

PHOTODIODE**RATINGS**

Reverse voltage $V_R \leq 30 \text{ V}$

CHARACTERISTICS

Monitor diode sensitivity (ratio of photodiode current to optical power emitted by collimator pen)
at $\phi_e = 2 \text{ mW}$

typ. 0,6 A/W

Dark reverse current

at $V_R = 15 \text{ V}$

$I_{R(D)} < 10 \text{ nA}$

Capacitance

at $V_R = 0$

$C_c < 5 \text{ pF}$

ENVIRONMENTAL TESTS

The device meets all specifications mentioned below 2 hours after each test. During these tests the collimator pen is not operating.

DEVELOPMENT DATA

test	in accordance with	conditions
Rapid change of temperature	IEC 68-2-14, test Na	-25 °C to 25 °C to 70 °C to 25 °C; duration of each exposure 30 min and 10 cycles in total
Dry heat	IEC 68-2-2, test Bc	Temperature: 70 °C Duration: 7 days
Cold	IEC 68-2-1 test Aa	Temperature: -25 °C Duration: 7 days
Damp heat, steady state	IEC 68-2-3 test Ca	Temperature: 40 °C Relative humidity (R.H.): 90-95% Duration: 42 days
Damp heat, cyclic	IEC 68-2-30 test Db	Temp./R.H. 45 °C/100% (12 h) to 25 °C/ 85% (12 h) Duration of one cycle: 24 hours Number of cycles: 42
Vibration	IEC 68-2-6 test Db	Frequency range: 10-55 Hz Amplitude: 0,75 mm Duration: 6 hours (2 h in each of directions)
Shock	IEC 68-2-27 test Ea	Pulse shape: half-sine Pulse duration: 11 ms Peak acceleration: 981 m/s ² Number of shocks: 10 in each of 3 directions
Bump	IEC 68-2-29 test Eb	Pulse duration: 6 ms Peak acceleration: 390 m/s ² Number of bumps: 1000 Axes of direction: 6

Cleaning test The cylinder lens at the side of the long conjugate is cleaned 100x with a small piece of cotton wool, soaked in a 45-95% solution of ethyl-alcohol in water, attached to the end of a small stick.

OPERATING PRECAUTIONS

Semiconductor lasers in general are easily damaged by overdriving and transients. Electrically, the laser diode is a very reliable device and can easily withstand current surges of several amperes. Optically, however, the diode laser is more susceptible to damage because of the extremely high optical flux density passing through both facets, while in operation. By overdriving or transients to the laser, even for pulses in the nanosecond region, the optical flux density can rise to unacceptable values (10 to 100 MW/cm²), causing gradual or catastrophic degradation of the laser facets. Current transients should therefore be carefully avoided; they decrease the laser life time.

CAUTION

Aluminium gallium arsenide lasers emit radiation which is invisible to the human eye. When in use, do not look directly into the device. Direct viewing of laser light at close ranges, especially in conjunction with collimating lenses, may cause eye damage.

The device meets the requirements of safety class 3B of the international standard code.

DEVELOPMENT DATA

This data sheet contains advance information and specifications are subject to change without notice.

502CQF

BURIED HETEROJUNCTION InGaAsP LASER DIODE WITH FIBRE PIGTAIL

The 502CQF is an InGaAsP buried heterojunction semiconductor laser diode. The device is designed for high-speed long distance, optical communications and data transmissions.

The diode laser, emitting in the 1300 nm transmission window of optical fibres, is mounted in a specifically designed hermetic SOT-184 encapsulation.

The 502CQF is standard equipped with a fast-responding photodiode optically coupled to the rear facet of the laser for monitoring the laser radiant output power. A graded index optical fibre pigtail with dimensions 50/125/950 μm is coupled to the front facet of the laser.

MECHANICAL DATA

Dimensions in mm

Fig. 1 SOT-184.

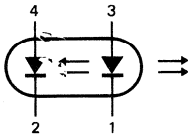
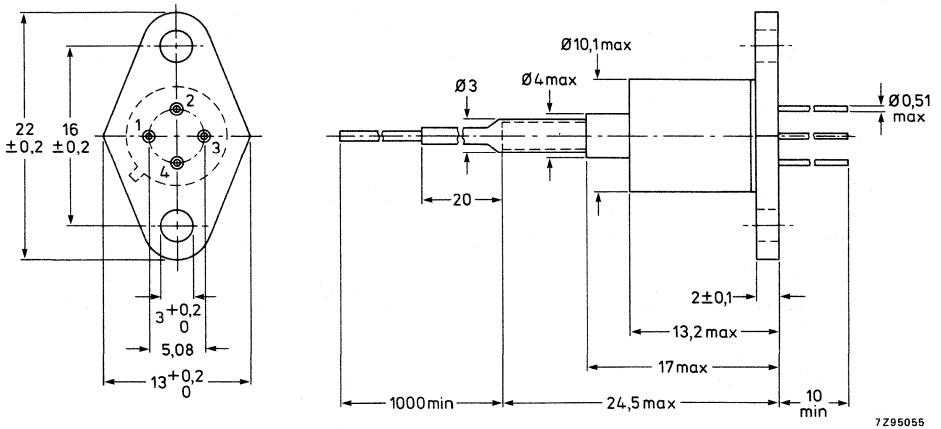

LASER

The buried heterojunction InGaAsP laser is designed to operate at a radiant output level of up to 3 mW in the fibre, up to relatively high case temperatures (60 °C) and at an emission wavelength of 1300 nm. All lasers have been subjected to a burn-in test at a radiant output level of 3 mW at a case temperature of 60 °C.

RATINGS

Limiting values in accordance with the Absolute Maximum System (IEC 134)

Radiant output power from fibre pigtail	ϕ_e	max.	3 mW
---	----------	------	------

CHARACTERISTICS

Threshold current $T_C = 30\text{ °C}$	I_{th}	typ. max.	25 mA 40 mA
Radiant output power from fibre pigtail $T_C = 60\text{ °C}$	ϕ_e	max.	3 mW
Forward voltage drop $\phi_e = 2\text{ mW}$	V_F	max.	1,5 V
Wavelength at peak emission	λ_p	typ.	1300 nm
Spectral width at half intensity	$\Delta\lambda$	max.	1 nm
at 10% intensity		max.	4 nm
Rise time, fall time laser biased near I_{th}	t_r, t_f	typ.	0,5 ns
Temperature coefficient of wavelength	$\frac{d\lambda_p}{dT}$	typ.	0,5 nm/K
Temperature coefficient of threshold current	$\frac{1}{I_{th}} \cdot \frac{dI_{th}}{dT}$	typ.	2 %/K
Differential efficiency (stimulated emission)	ϵ	typ.	0,1 mW/mA
Extinction ratio $\phi_e = 3\text{ mW}$		typ.	1:50
PHOTODIODE			
Reverse voltage	V_R	max.	5 V
Dark reverse current $V_R = 5\text{ V}$	I_{RD}	typ.	10 μA
Monitor diode current	I_R		100 to 300 $\mu\text{A/mW}$

FIBRE PIGTAIL

Graded index silica rubber

		min.	typ.	max.
numerical aperture on axis	NA	0,20	0,21	0,22
core diameter	ϕ_{core}	48	50	52 μm
cladding diameter	ϕ_{clad}	123	125	127 μm
primary coating thickness	ϕ_{pc}		20	μm
secondary coating diameter	ϕ_{sc}		950	μm

Options: other fibre for pigtail may be accommodated.

Options may be subject to surcharge.

TEMPERATURES (total assembly)

C.W. operation	T_{op}		0 to 60 °C
Storage	T_{stg}		-40 to +100 °C
Thermal resistance from junction to case	$R_{\text{th j-c}}$	typ.	45 K/W

OPERATING PRECAUTIONS

Semiconductor lasers in general are easily damaged by overdriving and electrical transients. Electrically, the laser diode is a very reliable device and can easily withstand current surges of several amperes.

Optically, however, the diode laser is more susceptible to damage because of the extremely high optical flux density passing through both facets, while in operation. By overdriving or transients to the laser, even for pulses in the nanosecond region, the optical flux density can rise to unacceptable values (10 to 100 MW/cm²), causing gradual or catastrophic degradation of the laser facets.

Current transients should therefore be carefully avoided; they can substantially decrease the laser life time and may cause mortal damage. Before connecting the laser to the supply circuit, make sure that there are no transients which could make the laser output exceeding the maximum ratings for radiant flux or forward current. The connection and disconnection of the laser to or from a power supply must be made only after reducing the voltage to the minimum and setting the output control to the zero position.

Avoid poor electrical connection on the load side of the power supply circuit, as this may cause the laser voltage to rise if the power supply is operated in constant current mode.

WARNING

The laser diode is extremely sensitive to electrostatic discharges. The anode and the cathode shall therefore always be shorted when the diode is disconnected.

CAUTION

Indium gallium arsenide phosphide lasers emit radiation which is invisible to the human eye. When in use, do not look directly into the device. Direct viewing of laser light at close ranges, especially in conjunction with collimating lenses, may cause eye damage.

The device falls within safety class 3B of the international standard code.

Note: Each laser is accompanied by an individual test sheet, showing the $P_{\text{opt}} - I_{\text{op}}$ characteristic and the monitor current for a given optical output power.

DEVELOPMENT DATA

This data sheet contains advance information and specifications are subject to change without notice.

503CQF

BURIED HETEROJUNCTION InGaAsP LASER DIODE WITH SINGLE MODE FIBRE PIGTAIL

The 503CQF is an InGaAsP buried heterojunction semiconductor laser diode. The device is designed for high-speed long distance, optical communications and data transmissions.

The diode laser, emitting in the 1300 nm transmission window of optical fibres, is mounted in a specifically designed hermetic encapsulation (modified TO-5). The 503CQF is standard equipped with a fast-responding photodiode optically coupled to the rear facet of the laser for monitoring the laser radiant output power. A single mode optical fibre pigtail with dimensions 8/125/950 μm is coupled to the front facet of the laser.

MECHANICAL DATA

Dimensions in mm

Fig. 1 SOT-184.

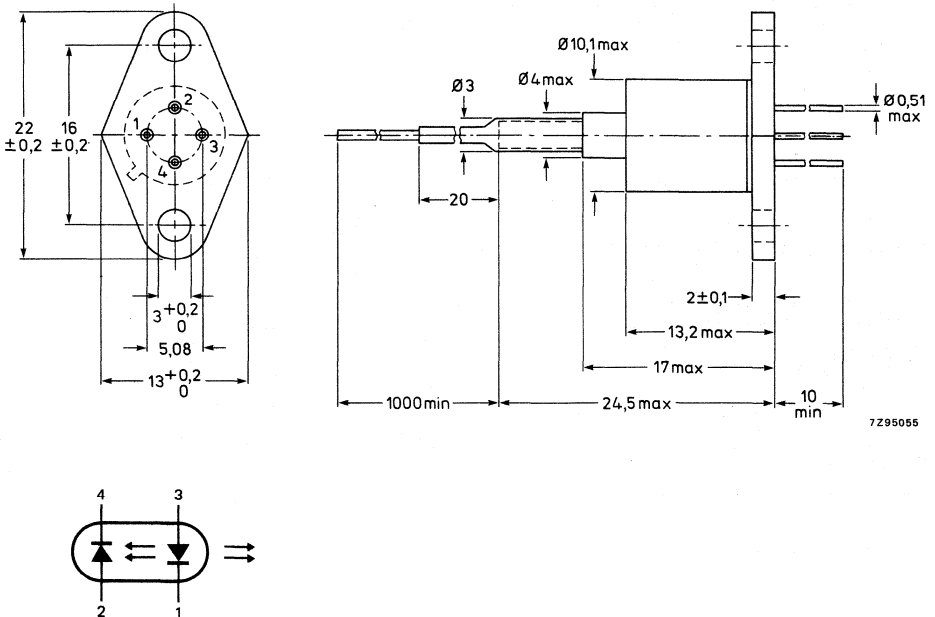

LASER

The buried heterojunction InGaAsP laser is designed to operate at a radiant output level of up to 2 mW in the fibre, up to relatively high case temperatures (60 °C) and at an emission wavelength of 1300 nm. All lasers have been subjected to a burn-in test at a radiant output level of 2 mW at a case temperature of 60 °C.

RATINGS

Limiting values in accordance with the Absolute Maximum System (IEC 134)

Radiant output power from fibre pigtail	ϕ_e	max.	2 mW
---	----------	------	------

CHARACTERISTICS

Threshold current

$T_c = 30\text{ °C}$

I_{th}	typ.	25 mA
	max.	40 mA

Radiant output power from fibre pigtail

$T_c = 60\text{ °C}$

ϕ_e	max.	1,5 mW
----------	------	--------

Forward voltage drop

$\phi_e = 2\text{ mW}$

V_F	max.	1,5 V
-------	------	-------

Wavelength at peak emission

λ_p	typ.	1300 nm
-------------	------	---------

Spectral width

at half intensity

at 10% intensity

$\Delta\lambda$	max.	1 nm
	max.	4 nm

Rise time, fall time

laser biased near I_{th}

t_r, t_f	typ.	0,5 ns
------------	------	--------

Temperature coefficient of wavelength

$\frac{d\lambda_p}{dT}$	typ.	0,5 nm/K
-------------------------	------	----------

Temperature coefficient of threshold current

$\frac{1}{I_{th}} \cdot \frac{dI_{th}}{dT}$	typ.	2 %/K
---	------	-------

Differential efficiency
(stimulated emission)

	typ.	0,1 mW/mA
--	------	-----------

Extinction ratio

$\phi_e = 1,5\text{ mW}$

ϵ	typ.	1:50
------------	------	------

PHOTODIODE

Reverse voltage

V_R	max.	5 V
-------	------	-----

Dark reverse current

$V_R = 5\text{ V}$

I_{RD}	typ.	20 μA
----------	------	------------------

Monitor diode current

I_R		100 to 300 $\mu\text{A/mW}$
-------	--	-----------------------------

FIBRE PIGTAIL

Single mode

		min.	typ.	max.
mode field diameter	ϕ_{core}		8	μm
eccentricity of core				1,5 μm
cladding diameter	ϕ_{clad}	123	125	127 μm
primary coating thickness	ϕ_{pc}		20	μm
secondary coating diameter	ϕ_{sc}		950	μm

Options: other fibre for pigtail may be accommodated.

Options may be subject to surcharge.

TEMPERATURES (total assembly)

C.W. operation	T_{op}			0 to 60 °C
Storage	T_{stg}			-40 to +100 °C
Thermal resistance from junction to case	$R_{th j-c}$	typ.		45 K/W

OPERATING PRECAUTIONS

Semiconductor lasers in general are easily damaged by overdriving and electrical transients. Electrically, the laser diode is a very reliable device and can easily withstand current surges of several amperes.

Optically, however, the diode laser is more susceptible to damage because of the extremely high optical flux density passing through both facets, while in operation. By overdriving or transients to the laser, even for pulses in the nanosecond region, the optical flux density can rise to unacceptable values (10 to 100 MW/cm²), causing gradual or catastrophic degradation of the laser facets.

Current transients should therefore be carefully avoided; they can substantially decrease the laser life time and may cause mortal damage. Before connecting the laser to the supply circuit, make sure that there are no transients which could make the laser output exceeding the maximum ratings for radiant flux or forward current. The connection and disconnection of the laser to or from a power supply must be made only after reducing the voltage to the minimum and setting the output control to the zero position.

Avoid poor electrical connection on the load side of the power supply circuit, as this may cause the laser voltage to rise if the power supply is operated in constant current mode.

WARNING

The laser diode is extremely sensitive to electrostatic discharges. The anode and the cathode shall therefore always be shorted when the diode is disconnected.

CAUTION

Indium gallium arsenide phosphide lasers emit radiation which is invisible to the human eye. When in use, do not look directly into the device. Direct viewing of laser light at close ranges, especially in conjunction with collimating lenses, may cause eye damage.

The device falls within safety class 3B of the international standard code.

Note : Each laser is accompanied by an individual test sheet, showing the $P_{opt} - I_{op}$ characteristic and the monitor current for a given optical output power.

DEVELOPMENT DATA

DEVELOPMENT DATA

This data sheet contains advance information and specifications are subject to change without notice.

504CQL
(CQL20)

AIGaAs DOUBLE HETEROSTRUCTURE VISIBLE LASER-DIODE

The 504CQL is designed for reading applications such as: video-audio disc applications, optical memories, security systems, etc.

This device is mounted in an hermetic SOT-148 encapsulation specifically designed for easy alignment in an optical read system. The copper heatsink is circular and precision engineered with a diameter accuracy of $+0, -9 \mu\text{m}$. Laserstripe and mechanical axis coincide within $50 \mu\text{m}$.

The 504CQL is standard equipped with a photo p-i-n diode, optically coupled to the rear emitting facet of the laser. This fast responding (less than 20 ns) photodiode can be used as a sensor to control the laser radiant output level. The ultra-flat top window (flat within two fringes) guarantees an unperturbed beam wavefront.

QUICK REFERENCE DATA

Threshold current at $T_c = 30^\circ\text{C}$

I_{th} typ. 60 mA ←

C.W. radiant output power up to $T_c = 60^\circ\text{C}$

ϕ_e typ. 5 mW ←

Wavelength at peak emission

λ_p typ. 780 nm

MECHANICAL DATA

Dimensions in mm

Fig. 1 SOT-148A.

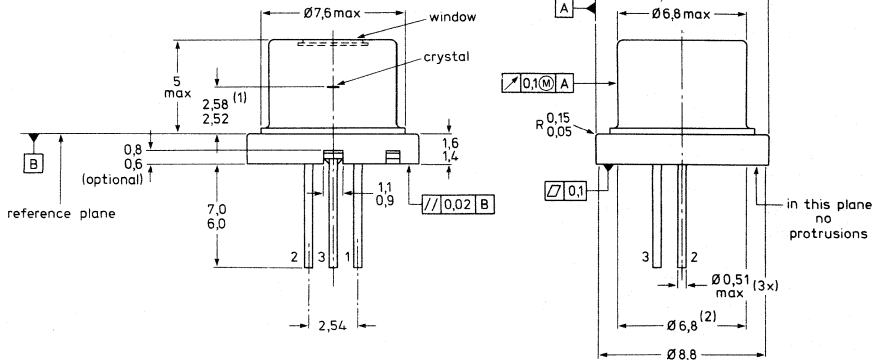

- (1) Position of the laser crystal from the reference plane.
- (2) Within the plane of $\phi 6,8$ protrusions and irregularities are permitted.
- (3) The positional accuracy of the laser strip with respect to the flange diameter.

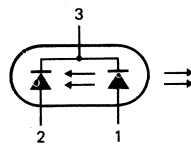
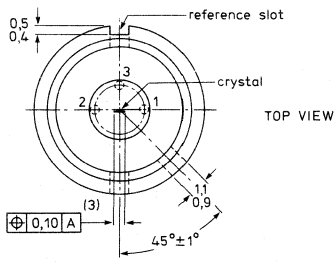

LASER

The double heterostructure stripe laser is made by using internal current confinement. The structure is designed to operate C.W. 5 mW at a wavelength of 780 nm. The device is primarily intended for reading applications of Compact Discs (DAD) and Video Long Play records.

All lasers have been subjected to a burn-in test at rated radiant output level and at elevated case temperature.

→ **RATINGS**

Limiting values in accordance with the Absolute Maximum System (IEC 134)

Radiant output power	ϕ_e	max.	7 mW
Reverse voltage	V_R	max.	2 V
Temperatures (<i>both laser and photodiode</i>)			
c.w. operation	T_C		-10 to + 60 °C
storage	T_{stg}		-40 to + 85 °C

→ **CHARACTERISTICS**

Threshold current			
at $T_C = 30\text{ °C}$	I_{th}	typ.	60 mA
at $T_C = 60\text{ °C}$	I_{th}	typ.	80 mA
Operating current			
$\phi_e = 5\text{ mW}; T_C = 30\text{ °C}$	I_{op}	typ.	80 mA
		max.	100 mA
Recommended operating radiant output power up to $T_C = 60\text{ °C}$	ϕ_e	typ.	5 mW
Forward voltage drop up to $T_C = 60\text{ °C}$			
$\phi_e = 5\text{ mW}$	V_F	typ.	1,7 V
		max.	2,2 V
Wavelength at peak emission			
$\phi_e = 5\text{ mW}; T_C = 30\text{ °C}$	λ_p		$780 \pm 15\text{ nm}$
Spectral width at half height			
$\phi_e = 5\text{ mW}$	$\Delta\lambda$	typ.	2 nm
Far-field angle at half-intensity directions (FWHM)*			
$\phi_e = 2\text{ mW}; T_C = 30\text{ °C}$			
perpendicular to the junction plane	$\theta_{1/2} (\perp)$	typ.	30 °
parallel to the junction plane	$\theta_{1/2} (\parallel)$	typ.	12 °
Astigmatism (distance between focal lines)	A_D	typ.	11 μm
Series resistance	R_S	typ.	2 Ω
Differential efficiency at $\phi_e = 2\text{ mW}$	ϵ	typ.	0,25 W/A
Spontaneous emission at I_{th}	ϕ_{spont}	typ.	0,1 mW
Turn-on/turn-off time (above threshold)	t_{on}/t_{off}	typ.	1 ns
Temperature coefficient of wavelength	$\frac{d\lambda_p}{dT}$	typ.	0,25 nm/K
Thermal resistance			
from junction to case	$R_{th\ j-c}$	typ.	50 K/W

* FWHM stands for full width half maximum.

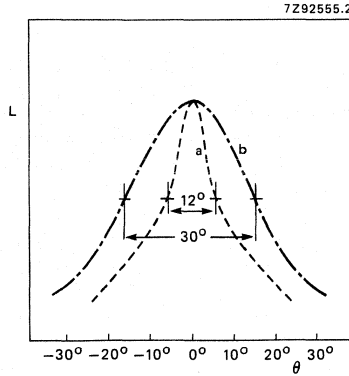

Fig. 2 Far-field pattern.
a. parallel to the junction plane.
b. perpendicular to the junction plane.

PHOTODIODE

DEVELOPMENT DATA

RATINGS

Limiting values in accordance with the Absolute Maximum System (IEC 134)

Reverse voltage V_R max. 30 V

CHARACTERISTICS

Luminous sensitivity at $V_R = 15$ V N typ. 0,3 A/W

Dark reverse current at $V_R = 15$ V $I_R(D)$ max. 10 nA

Capacitance at $V_R = 0$ C_d max. 5 pF

Monitor diode current response at $V_R = 7,5$ V $I_R(L)$ 0,25–0,75 A/W

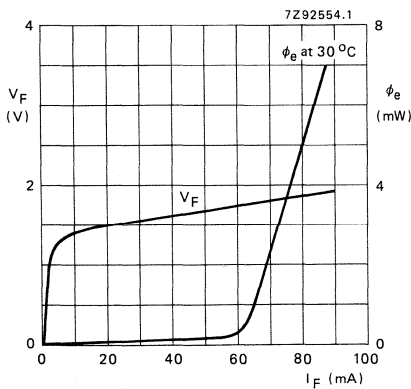

Fig. 3 Forward voltage drop (V_F) and radiant output power (ϕ_e) of laser diode as a function of forward current; typical values.

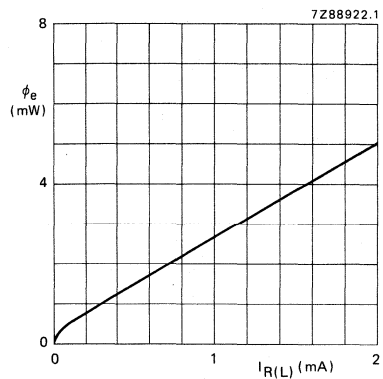

Fig. 4 Radiant output power (ϕ_e) as a function of monitor current of photodiode; V_R (photodiode) = 7,5 V; typical values.

OPERATING PRECAUTIONS

Semiconductor lasers in general are easily damaged by overdriving and electrical transients. Electrically, the laser diode is a very reliable device and can easily withstand current surges of several amperes. Optically, however, the diode laser is more susceptible to damage because of the extremely high optical flux density passing through both facets, while in operation. By overdriving or transients to the laser, even for pulses in the nanosecond region, the optical flux density can rise to unacceptable values (10 to 100 MW/cm²), causing gradual or catastrophic degradation of the laser facets.

Current transients should therefore be carefully avoided; they can substantially decrease the laser life time and may cause mortal damage. Before connecting the laser to the supply circuit, make sure that there are no transients which could make the laser output exceeding the maximum ratings for radiant flux or forward current. The connection and disconnection of the laser to or from a power supply must be made only after reducing the voltage to the minimum and setting the output control potentiometer to the zero position.

Avoid poor electrical connection on the load side of the power supply circuit, as this may cause the laser voltage to rise if the power supply is operated in constant current mode.

CAUTION

Aluminium gallium arsenide lasers emit radiation which is invisible to the human eye. When in use, do not look directly into the device. Direct viewing of laser light at close ranges, especially in conjunction with collimating lenses, may cause eye damage.

The device falls within safety class 3B of the international standard code.

WARNING

The laser diode is extremely sensitive to electrostatic discharges. The anode and the cathode shall therefore always be shorted when the diode is disconnected.

DEVELOPMENT DATA

This data sheet contains advance information and specifications are subject to change without notice.

516CQF-B

DOUBLE HETEROSTRUCTURE AlGaAs DIODE LASER WITH FIBRE PIGTAIL

The 516CQF-B is an AlGaAs double heterostructure semiconductor laser designed for high speed (560 Mb/s), long distance, optical communications.

The diode laser, emitting in the first transmission window of silica optical fibres, is mounted in a specifically designed hermetic encapsulation.

The 516CQF-B is standard equipped with a fast-responding photodiode optically coupled to the rear facet of the laser for monitoring the laser radiant output power. A silica graded index optical fibre pigtail is coupled to the front facet of the laser.

The monitor diode is electrically insulated from the case.

MECHANICAL DATA

Dimensions in mm

Fig. 1 SOT-184.

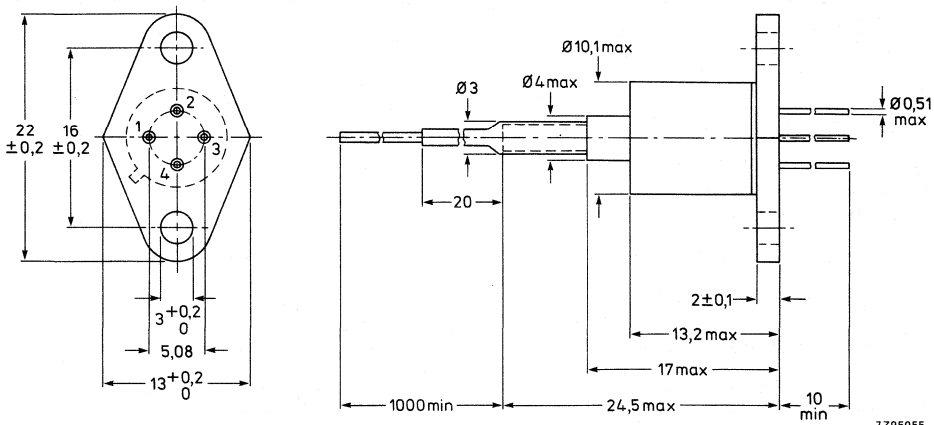

7295055

LASER

The double heterostructure laser, made by means of the MOVPE process, with very narrow stripe operates in a stable single transverse mode (TE_{00}) over the full power range and in several longitudinal modes. This results in a rather short coherence length, which is advantageous in suppressing modal noise and optical feedback effects.

The structure is designed to operate at a radiant output level of up to 3 mW in the fibre, up to relatively high case temperatures (60 °C) and at an emission wavelength of 850 nm.

All lasers have been subjected to a burn-in test at radiant output level from the laser facet of 5 mW at a case temperature of 60 °C.

RATINGS

Limiting values in accordance with the Absolute Maximum System (IEC 134)

Radiant output power from fibre pigtail	ϕ_e	max.	5 mW
Reverse voltage	V_R	max.	1 V

CHARACTERISTICS

Threshold current			
$T_c = 30\text{ °C}$	I_{th}	typ.	90 mA
$T_c = 60\text{ °C}$	I_{th}	typ.	120 mA
		max.	150 mA
Radiant output power from fibre pigtail			
$T_c = 60\text{ °C}$	ϕ_e	typ.	3 mW
Forward voltage drop			
$\phi_e = 3\text{ mW}$	V_F	typ.	2,5 V
Wavelength at peak emission	λ_p	typ.	850 nm
Spectral width at half intensity	$\Delta\lambda$	typ.	3 nm
Rise time, fall time laser biased near I_{th}	t_r, t_f	typ.	0,5 ns
Spectrum at $\phi_e = 1\text{ mW}$ (FWHM)		typ.	10 longitudinal modes
Extinction ratio at $\phi_e = 3\text{ mW}$			1 : 10
Temperature coefficient of wavelength	$\frac{d\lambda_p}{dT}$	typ.	0,25 nm/K
Temperature coefficient of I_{th}	$\frac{1}{I_{th}} \cdot \frac{dI_{th}}{dt}$	typ.	1 %/K
Differential efficiency (stimulated emission)	ϵ	typ.	0,1 mW/mA
PHOTODIODE			
Reverse voltage	V_R	max.	30 V
Responsivity $V_R = 15\text{ V}$	N	typ.	0,5 A/W
Dark reverse current $V_R = 15\text{ V}$	I_{RD}	max.	10 nA
Capacitance $V_R = 0$	C_d	max.	5 pF
Monitor diode current	I_F		100 to 300 $\mu\text{A/mW}$

FIBRE PIGTAIL

Graded index silica		min.	typ.	max.
numerical aperture on axis	NA	0,20	0,21	0,22
core diameter	ϕ_{core}	48	50	52 μm
cladding diameter	ϕ_{clad}	123	125	127 μm
primary coating thickness	ϕ_{pc}		20	μm
secondary coating diameter	ϕ_{sc}		950	μm

Options: other fibre for pigtail may be made available.

other wavelengths are available and are specified by adding a suffix to the type number accordingly:

suffix A	= 820 nm
suffix B	= 850 nm
suffix C	= 870 nm

Options may be subject to surcharge.

TEMPERATURES (total assembly)

C.W. operation	T_{op}		0 to 60 °C
Storage	T_{stg}		-20 to +100 °C
Thermal resistance junction to case	$R_{\text{th j-c}}$	typ.	45 K/W

OPERATING PRECAUTIONS

Semiconductor lasers in general are easily damaged by overdriving and electrical transients. Electrically, the laser diode is a very reliable device and can easily withstand current surges of several amperes. Optically, however, the diode laser is more susceptible to damage because of the extremely high optical flux density passing through both facets, while in operation. By overdriving or transients to the laser, even for pulses in the nanosecond region, the optical flux density can rise to unacceptable values (10 to 100 MW/cm²), causing gradual or catastrophic degradation of the laser facets.

Current transients should therefore be carefully avoided; they can substantially decrease the laser life time and may cause mortal damage. Before connecting the laser to the supply circuit, make sure that there are no transients which could make the laser output exceed the maximum ratings for radiant flux or forward current. The connection and disconnection of the laser to or from a power supply must be made only after reducing the voltage to the minimum and setting the output control to the zero position.

Avoid poor electrical connection on the load side of the power supply circuit, as this may cause the laser voltage to rise if the power supply is operated in constant current mode.

WARNING

The laser diode is extremely sensitive to electrostatic discharges. The anode and the cathode shall therefore always be short-circuited when the diode is disconnected.

CAUTION

Aluminum gallium arsenide lasers emit radiation which is invisible to the human eye. When in use, do not look directly into the device. Direct viewing of laser light at close ranges, especially in conjunction with collimating lenses, may cause eye damage.

The device falls within safety class 3B of the international standard code.

Note: Each laser is accompanied by an individual test sheet, showing the $\phi_e - I_{\text{op}}$ characteristic and the monitor current for a given optical output power.

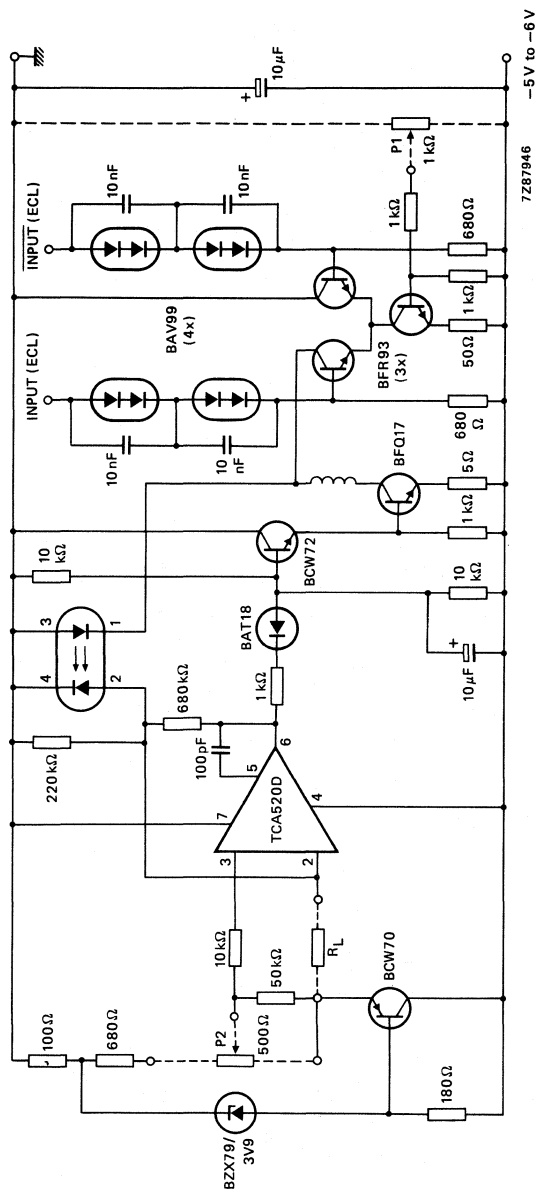

Fig. 2 Typical modulation circuit with ECL logic input and control of average optical power output. Data rate > 200 Mb/s.

- P1 sets the peak-peak modulation current.
- P2 sets the laser bias current.
- RL determines maximum mean value of optical output power.
- 1-2-3-4 laser connections.

Note: if single ECL drive is applied, the other input shall be connected to the ECL threshold level (-1.35 V).

SECTION C2

Infrared sensors

PYROELECTRIC INFRARED DETECTORS

In line with our policy of continual improvement, some of our original ceramic pyroelectric detectors have been superseded by more advanced, lower-cost devices. The tables on the following pages give details of the original detectors and their replacements. Greater detail for the current types is available in our published data.

The replacement types are specified with a unity gain source follower circuit. The responsivity levels will therefore appear to be approximately $\times 5$ lower than the types they replace, since the latter were specified with a gain of $\times 4.8$ with the exception of the RPY96, which was specified with a unity gain source follower circuit.

RPY86

MECHANICAL DATA

SOT-49E (low profile TO-5)

Dimensions in mm

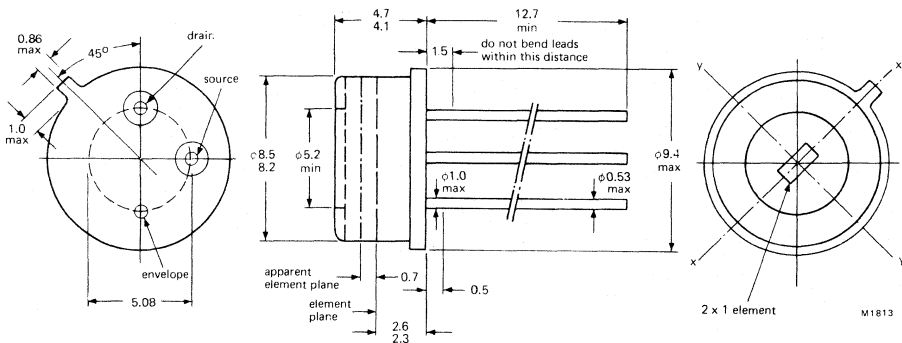

RPY87

MECHANICAL DATA

SOT-49E (low profile TO-5)

Dimensions in mm

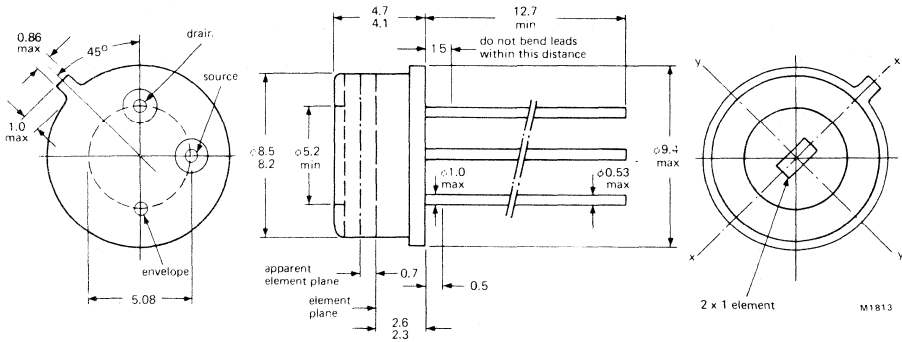

RPY88

MECHANICAL DATA

SOT-49E (low profile TO-5)

Dimensions in mm

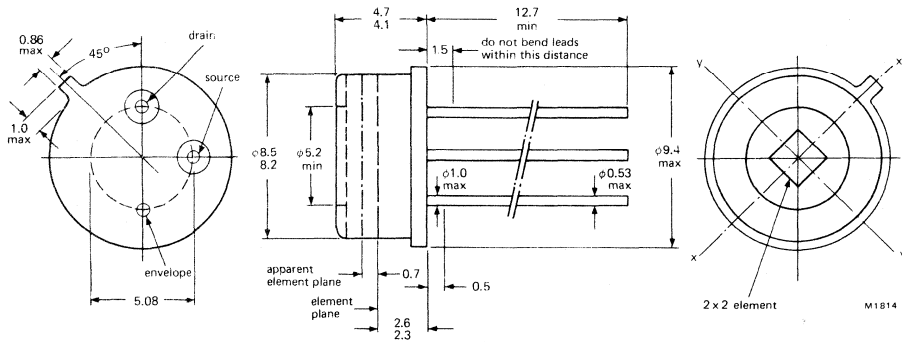

REPLACEMENT TYPES

SINGLE ELEMENT PYROELECTRIC INFRARED DETECTORS

RPY100

MECHANICAL DATA SOT-49H (TO-5 variant)

Dimensions in mm

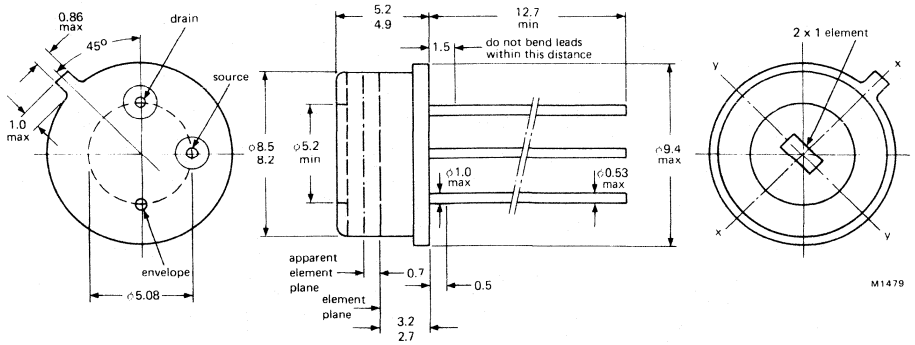

RPY107

MECHANICAL DATA SOT-49H (TO-5 variant)

Dimensions in mm

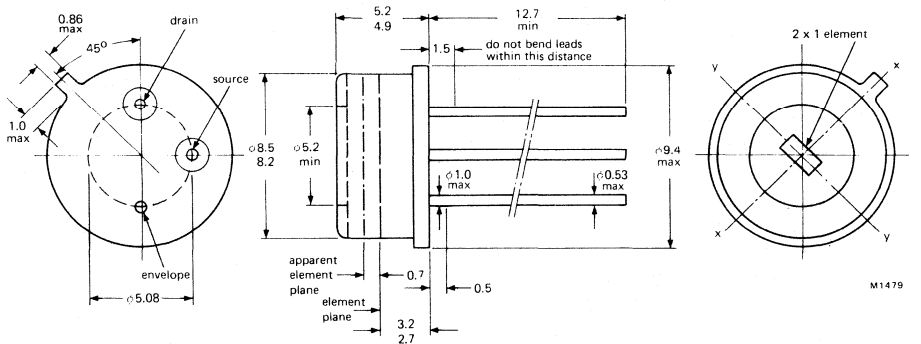

RPY102

MECHANICAL DATA SOT-49H (TO-5 variant)

Dimensions in mm

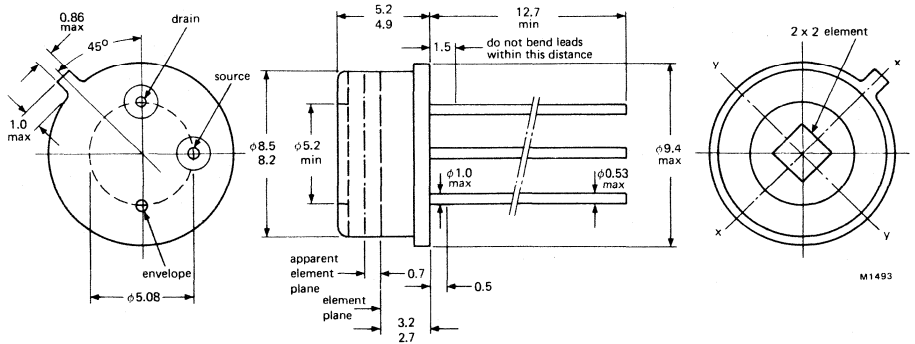

RPY89

MECHANICAL DATA
SOT-49E (low profile TO-5)

Dimensions in mm

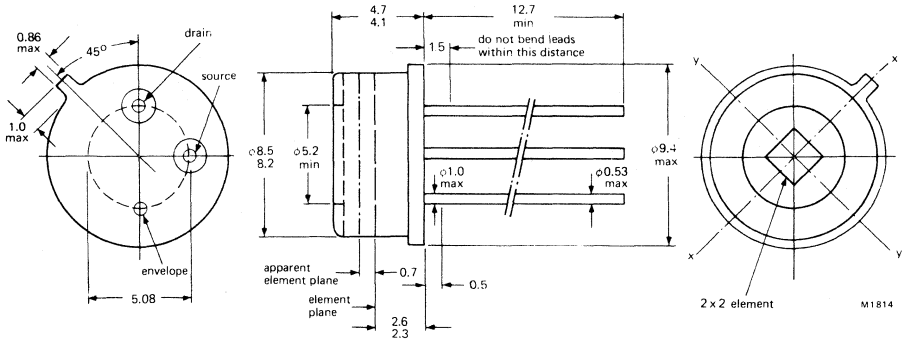

RPY96

MECHANICAL DATA
SOT-49F (low profile TO-5)

Dimensions in mm

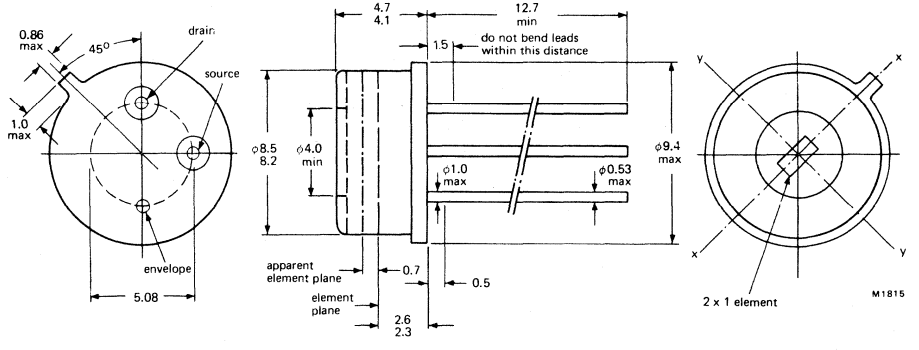

REPLACEMENT TYPES

SINGLE ELEMENT PYROELECTRIC INFRARED DETECTORS

RPY109

MECHANICAL DATA SOT-49H (TO-5 variant)

Dimensions in mm

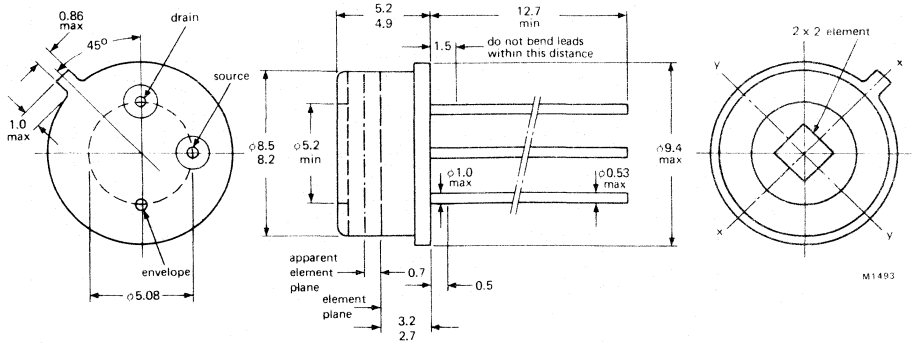

RPY100

MECHANICAL DATA SOT-49H (TO-5 variant)

Dimensions in mm

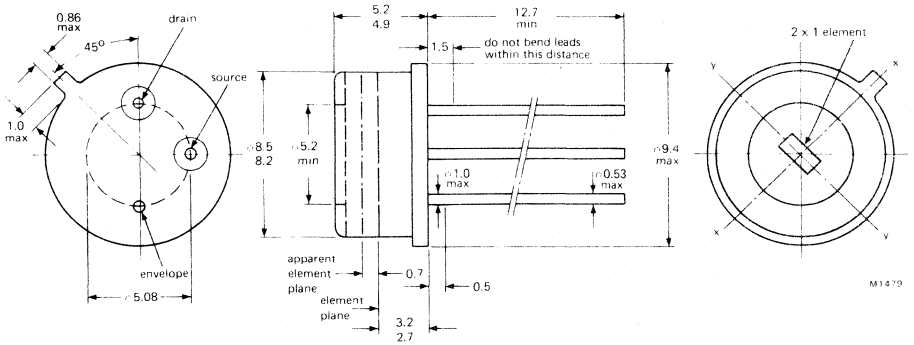

RPY93

MECHANICAL DATA

SOT-49E (low profile TO-5)

Dimensions in mm

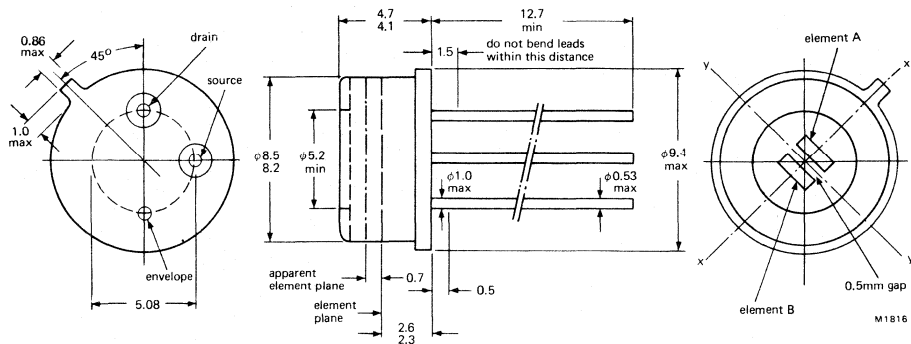

RPY94

MECHANICAL DATA

SOT-49E (low profile TO-5)

Dimensions in mm

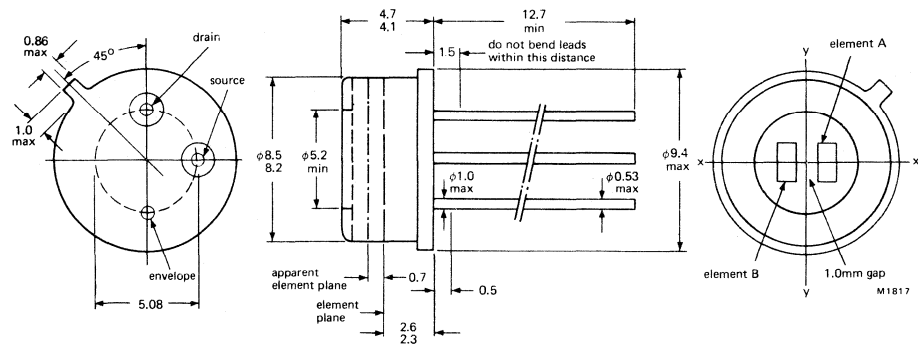

RPY95

MECHANICAL DATA

SOT-49F (low profile TO-5)

Dimensions in mm

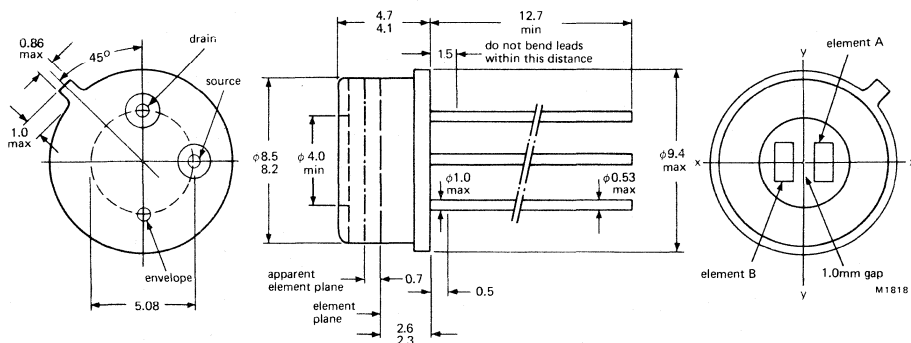

REPLACEMENT TYPES

DUAL ELEMENT PYROELECTRIC INFRARED DETECTORS

RPY103

MECHANICAL DATA
SOT-49H (TO-5 variant)

Dimensions in mm

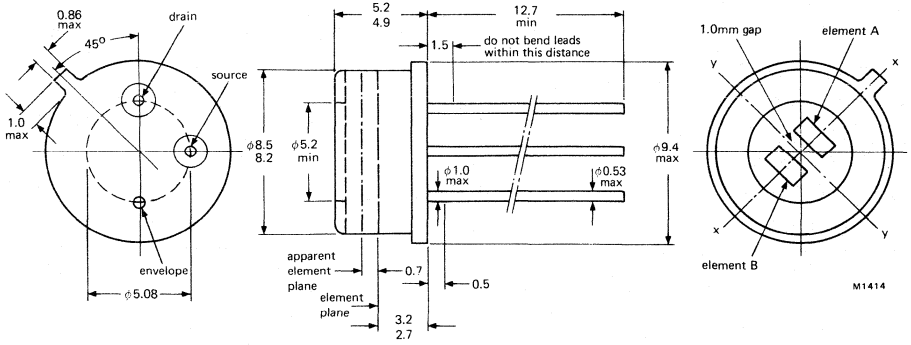

RPY97

MECHANICAL DATA
SOT-49H (TO-5 variant)

Dimensions in mm

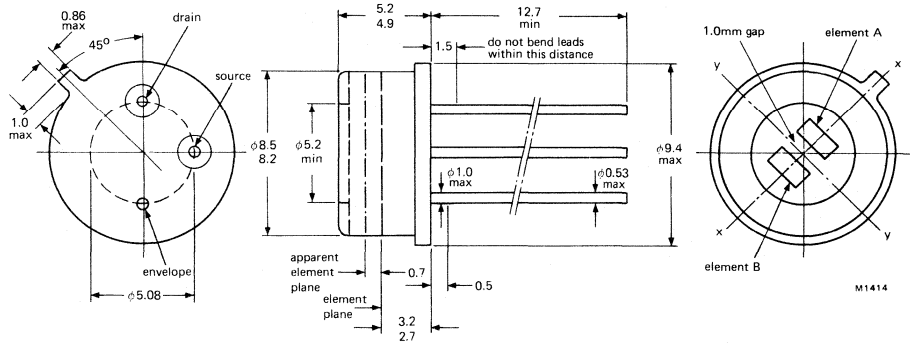

RPY97

MECHANICAL DATA
SOT-49H (TO-5 variant)

Dimensions in mm

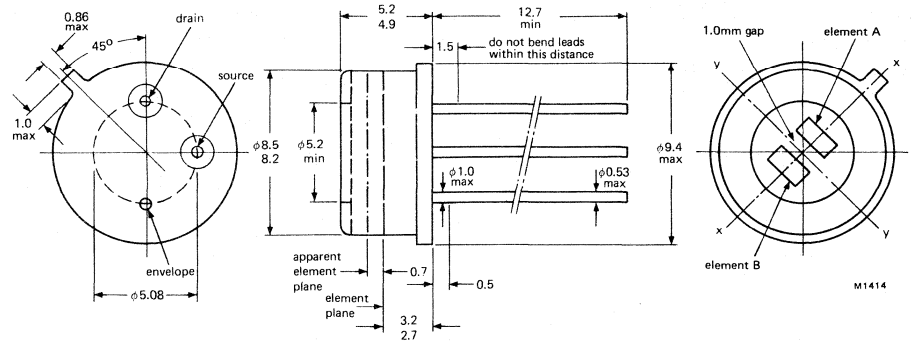

RPY86

QUICK REFERENCE DATA

Spectral Response		6.5 ± 0.5 to > 14	μm
Responsivity (10 μm, 10)	typ.	600	VW ⁻¹
Noise Equivalent Power (N.E.P.) (10 μm, 10, 1)	typ.	0.9 × 10 ⁻⁹	WHz ^{-1/2}
Element dimensions		2 × 1	mm
Field of View	typ.	110	degrees
Operating voltage		9	V
Optimum operating frequency range		0.1 to 1000	Hz

RPY87

QUICK REFERENCE DATA

Spectral Response		1.0 to > 15	μm
Responsivity (6 μm, 10)	typ.	500	VW ⁻¹
Noise Equivalent Power (N.E.P.) (6 μm, 10, 1)	typ.	1.05 × 10 ⁻⁹	WHz ^{-1/2}
Element dimensions		2 × 1	mm
Field of View	typ.	110	degrees
Operating voltage		9	V
Optimum operating frequency range		0.1 to 1000	Hz

RPY88

QUICK REFERENCE DATA

Spectral Response		6.5 ± 0.5 to > 14	μm
Responsivity (10 μm, 10)	typ.	300	VW ⁻¹
Noise Equivalent Power (N.E.P.) (10 μm, 10, 1)	typ.	1.65 × 10 ⁻⁹	WHz ^{-1/2}
Element dimensions		2 × 2	mm
Field of View	typ.	110	degrees
Operating voltage		9	V
Optimum operating frequency range		0.1 to 1000	Hz

RPY100

QUICK REFERENCE DATA

Spectral Response		6.5 ± 0.5 to >14	μm
Responsivity (10 μm, 10)	typ.	150	VW ⁻¹
Noise Equivalent Power (N.E.P.) (10 μm, 10, 1)	typ.	2.5 × 10 ⁻⁹	WHz ^{-1/2}
Peak signal (500 K, 1)	typ.	460	μV
Noise, peak-to-peak (bandwidth 0.5 Hz to 5 Hz)	typ.	20	μV
Element dimensions	nom.	2 x 1	mm
Field of View in horizontal plane (x-x)	typ.	110	degrees
Operating voltage	min.	3	V
Optimum operating frequency range		0.1 to 20	Hz

RPY107

QUICK REFERENCE DATA

Spectral Response		1.0 to >15	μm
Responsivity (500 K, 10)	typ.	130	VW ⁻¹
Noise Equivalent Power (N.E.P.) (500 K, 10, 1)	typ.	3.0 × 10 ⁻⁹	WHz ^{-1/2}
Element dimensions		2 x 1	mm
Field of View	typ.	110	degrees
Operating voltage		3	V
Optimum operating frequency range		0.1 to 20	Hz

RPY102

QUICK REFERENCE DATA

Spectral Response		6.5 ± 0.5 to >14	μm
Responsivity (10 μm, 10)	typ.	75	VW ⁻¹
Noise Equivalent Power (N.E.P.) (10 μm, 10, 1)	typ.	5.0 × 10 ⁻⁹	WHz ^{-1/2}
Peak signal (500 K, 1)	typ.	460	μV
Noise, peak-to-peak (bandwidth 0.5 Hz to 5 Hz)	typ.	15	μV
Element dimensions	nom.	2 x 2	mm
Field of view in horizontal plane (x-x)	typ.	110	degrees
Operating voltage	min.	3	V
Optimum operating frequency range		0.1 to 20	Hz

RPY89

QUICK REFERENCE DATA

Spectral Response		1.0 to > 15	μm
Responsivity (6 μm , 10)	typ.	250	VW^{-1}
Noise Equivalent Power (N.E.P.) (6 μm , 10, 1)	typ.	2.0×10^{-9}	$\text{WHz}^{-1/2}$
Element dimensions		2 x 2	mm
Field of View	typ.	110	degrees
Operating voltage		9	V
Optimum operating frequency range		0.1 to 1000	Hz

RPY96

QUICK REFERENCE DATA

Spectral Response		6.5 ± 0.5 to > 14	μm
Responsivity, (10 μm , 10)	typ.	130	VW^{-1}
Noise Equivalent Power (N.E.P.), (10 μm , 10, 1)	typ.	3.5×10^{-9}	$\text{WHz}^{-1/2}$
Element dimensions		2 x 1	mm
Field of view	typ.	105	degrees
Operating voltage		9	V
Optimum operating frequency range		0.1 to 1000	Hz

RPY109

QUICK REFERENCE DATA

Spectral response		1.0 to >15	μm
Responsivity (500 K, 10)	typ.	65	VW^{-1}
Noise Equivalent Power (N.E.P.) (500 K, 10, 1)	typ.	6.0×10^{-9}	$\text{WHz}^{-1/2}$
Peak signal (500 K, 1)	typ.	385	μV
Noise, peak-to-peak (bandwidth 0.5 Hz to 5 Hz)	typ.	15	μV
Element dimensions	nom.	2 x 2	mm
Field of view in horizontal plane (x-x)	typ.	110	degrees
Operating voltage	min.	3	V
Optimum operating frequency range		0.1 to 20	Hz

RPY100

QUICK REFERENCE DATA

Spectral Response		6.5 ± 0.5 to >14	μm
Responsivity (10 μm , 10)	typ.	150	VW^{-1}
Noise Equivalent Power (N.E.P.) (10 μm , 10, 1)	typ.	2.5×10^{-9}	$\text{WHz}^{-1/2}$
Peak signal (500 K, 1)	typ.	460	μV
Noise, peak-to-peak (bandwidth 0.5 Hz to 5 Hz)	typ.	20	μV
Element dimensions	nom.	2 x 1	mm
Field of View in horizontal plane (x-x)	typ.	110	degrees
Operating voltage	min.	3	V
Optimum operating frequency range		0.1 to 20	Hz

RPY93

QUICK REFERENCE DATA

Spectral Response		6.5 ± 0.5 to > 14	μm
Responsivity (10 μm, 10), each element	typ.	800	VW ⁻¹
Noise Equivalent Power (N.E.P.), (10 μm, 10, 1), each element	typ.	1.4 × 10 ⁻⁹	WHz ^{-1/2}
Element dimensions, each element		2 × 0.75	mm
Element separation		0.5	mm
Field of View in horizontal plane (x-x)	typ.	120	degrees
Operating voltage		9	V
Optimum operating frequency range		0.1 to 1000	Hz

RPY94

QUICK REFERENCE DATA

Spectral Response		6.5 ± 0.5 to > 14	μm
Responsivity (10 μm, 10), each element	typ.	650	VW ⁻¹
Noise Equivalent Power (N.E.P.) (10 μm, 10, 1), each element	typ.	1.5 × 10 ⁻⁹	WHz ^{-1/2}
Element dimensions, each element		2 × 1	mm
Element separation		1.0	mm
Field of View in horizontal plane (x-x)	typ.	130	degrees
Operating voltage		9	V
Optimum operating frequency range		0.1 to 1000	Hz

RPY95

QUICK REFERENCE DATA

Spectral Response		6.5 ± 0.5 to > 14	μm
Responsivity (10 μm, 10), each element	typ.	450	VW ⁻¹
Noise Equivalent Power (N.E.P.) (10 μm, 10, 1), each element	typ.	2.1 × 10 ⁻⁹	WHz ^{-1/2}
Element dimensions, each element		2 × 1	mm
Element separation		1.0	mm
Field of View in horizontal plane (x-x)	typ.	110	degrees
Operating voltage		9	V
Optimum operating frequency range		0.1 to 1000	Hz

REPLACEMENT TYPES

DUAL ELEMENT
PYROELECTRIC
INFRARED DETECTORS

RPY103

QUICK REFERENCE DATA

Spectral Response		6.5 ± 0.5 to >14	μm
Responsivity ($10 \mu\text{m}$, 10), each element	typ.	150	VW^{-1}
Noise Equivalent Power (N.E.P.) ($10 \mu\text{m}$, 10, 1), each element	typ.	2.2×10^{-9}	$\text{WHz}^{-1/2}$
Peak signal (500 K, 1)	typ.	460	μV
Noise, peak-to-peak (bandwidth 0.5 Hz to 5 Hz)	typ.	15	μV
Element dimensions, each element	nom.	2×1	mm
Element separation	nom.	1	mm
Field of View in horizontal plane (x-x)	typ.	130	degrees
Operating voltage	min.	3	V
Optimum operating frequency range		0.1 to 20	Hz

RPY97

QUICK REFERENCE DATA

Spectral Response		6.5 ± 0.5 to >14	μm
Responsivity ($10 \mu\text{m}$, 10), each element	typ.	150	VW^{-1}
Noise Equivalent Power (N.E.P.) ($10 \mu\text{m}$, 10, 1), each element	typ.	2.5×10^{-9}	$\text{WHz}^{-1/2}$
Noise, peak-to-peak (bandwidth 0.5 Hz to 5 Hz)	typ.	22	μV
Element dimensions, each element	nom.	2.1×0.9	mm
Element separation	nom.	1.0	mm
Field of View in horizontal plane (x-x)	typ.	130	degrees
Operating voltage	min.	3	V
Optimum operating frequency range		0.1 to 20	Hz

RPY97

QUICK REFERENCE DATA

Spectral Response		6.5 ± 0.5 to >14	μm
Responsivity ($10 \mu\text{m}$, 10), each element	typ.	150	VW^{-1}
Noise Equivalent Power (N.E.P.) ($10 \mu\text{m}$, 10, 1), each element	typ.	2.5×10^{-9}	$\text{WHz}^{-1/2}$
Noise, peak-to-peak (bandwidth 0.5 Hz to 5 Hz)	typ.	22	μV
Element dimensions, each element	nom.	2.1×0.9	mm
Element separation	nom.	1.0	mm
Field of View in horizontal plane (x-x)	typ.	130	degrees
Operating voltage	min.	3	V
Optimum operating frequency range		0.1 to 20	Hz

DUAL ELEMENT PYROELECTRIC INFRARED DETECTOR

This is an infrared sensitive device specifically intended for battery operated passive infrared movement sensors such as intruder alarms and light switches. It has differentially connected dual elements which provide immunity from common mode signals such as those generated by variations in ambient temperature, background radiation and acoustic noise. The wide separation of the elements makes this detector compatible with most optical systems. The dual elements are combined with a single impedance converting amplifier, which is specially designed to function from low voltage supplies with low current consumption. The detector will give an output signal only when the radiation falling on the elements is unbalanced, as in a focused system. It is sealed in a low profile TO-5 can with a window optically coated to restrict the response to wavelengths greater than 6.5 μm .

QUICK REFERENCE DATA

Spectral Response		6.5 ± 0.5 to >14	μm
Responsivity (10 μm , 10), each element (see circuit 1)	typ.	150	VW^{-1}
Responsivity (10 μm , 10), each element (see circuit 2)	typ.	720	VW^{-1}
Noise Equivalent Power (N.E.P.) (10 μm , 10, 1), each element	typ.	2.5×10^{-9}	$\text{WHZ}^{-\frac{1}{2}}$
Noise, peak-to-peak (bandwidth 0.5 Hz to 5 Hz)	typ.	22	μV
Element dimensions, each element	nom.	2.1×0.9	mm
Element separation	nom.	1.0	mm
Field of View in horizontal plane (x-x)	typ.	130	degrees
Operating voltage	min.	3	V
Optimum operating frequency range		0.1 to 20	Hz

This data must be read in conjunction with GENERAL SAFETY RECOMMENDATIONS—OPTOELECTRONIC DEVICES

MECHANICAL DATA

Dimensions in mm

SOT-49H (TO-5 variant)

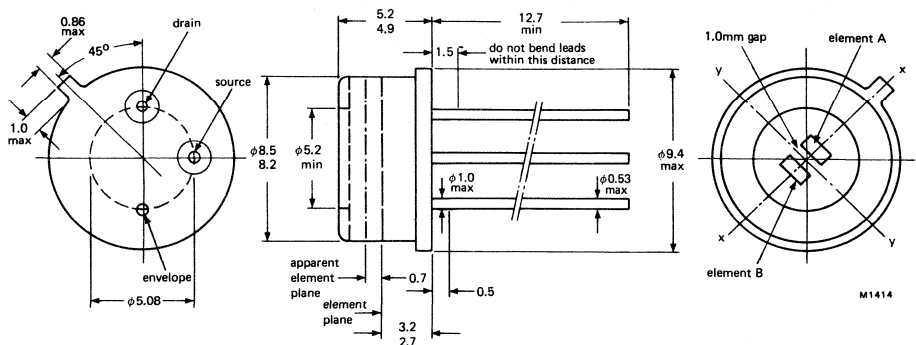

PRODUCT SAFETY

Modern high technology materials have been used in the manufacture of this device to ensure high performance. Some of these materials are toxic in certain circumstances. Mechanical or electrical damage is unlikely to give rise to any hazard, but toxic vapours may be generated if the device is heated to destruction. In the United Kingdom disposal of large quantities should therefore be carried out in accordance with the Deposit of Poisonous Waste Act 1972 and the Control of Pollution Act 1974, or with the latest legislation.

SOLDERING

1. When making soldered connections to the leads, a thermal shunt should be used.
2. It is essential that any mains operated soldering iron used should be both screened and earthed. Failure to observe these precautions may lead to the introduction of line voltages and possible damage to the device.

RATINGS

Limiting values in accordance with the Absolute Maximum System (IEC134).

Supply voltage	max.	30	V
Temperature, operating range		-40 to +70	°C
Temperature, storage range		-55 to +85	°C
Lead soldering temperature, ≥ 6 mm from header, $t_{sld} \leq 3$ s max.		+350	°C

OPERATING CONDITIONS

	min.	max.	
Voltage (operating note 5)	3	10	V
Frequency (operating note 5)	0.1	20	Hz

OPERATING NOTES

1. The case potential must not be allowed to become positive with respect to the other two terminals.
2. It is inadvisable to operate the detector at mains related frequencies.
3. To avoid the possibility of optical microphony, the detector must be firmly mounted.
4. An increase in temperature of element A will produce a positive going signal at the output. For element B, the corresponding output will be negative going.
5. The detector will operate outside the quoted range but may have a degraded performance.
6. Before testing, due to the high sensitivity of these detectors, care must be taken to ensure that the devices are allowed to become thermally stable.

CHARACTERISTICS (at $T_{amb} = 22\text{ }^{\circ}\text{C} \pm 3\text{ }^{\circ}\text{C}$ and with recommended circuit 1).

		min.	typ.	max.	
Spectral Response		6.5 ± 0.5	—	> 14	μm
Responsivity* (10 μm , 10)	note 1	95	150	—	VW^{-1}
Responsivity (10 μm , 10)	note 5	—	720	—	VW^{-1}
N.E.P. (10 μm , 10, 1)	note 1	—	2.5×10^{-9}	—	$\text{WHZ}^{-1/2}$
Element matching*	note 2	—	—	± 20	%
Noise*, peak-to-peak (bandwidth 0.5 Hz to 5 Hz)	note 4	—	22	50	μV
Field of View (x-x plane, total angle)	note 3	—	130	—	degrees
Quiescent current		—	10	—	μA
Element dimensions		2.1×0.9 nominal			mm
Element separation		1.0 nominal			mm

*These parameters are 100% tested with statistical sample quality inspection.

FET Characteristics (at $T_{amb} = 22\text{ }^{\circ}\text{C} \pm 3\text{ }^{\circ}\text{C}$)

		min.	typ.	max.	
Gate-Source Cut-off Voltage $I_D = 0.1\text{ }\mu\text{A}$, $V_{DS} = 6\text{ V}$	$V_{(P)GS}$	-1.2	—	-0.5	V
Transfer Conductance $V_{GS} = 0$, $V_{DS} = 6\text{ V}$, $f = 1.0\text{ kHz}$	g_{fso}	1.3	—	—	mAV^{-1}

Notes

- Each element. These characteristics apply throughout the spectral response range.
- With both elements irradiated, the matching of the element signals is derived from:—

$$\frac{\Delta S}{\frac{1}{2}(S_A + S_B)} \times 100$$
 where S_A and S_B are the signals of the two elements and ΔS is the signal with both elements irradiated.
- Field of view to 50% of the maximum signal level.
- Using low noise filter with 3 dB bandwidth and roll off at 12 dB per octave. Detectors tested for 1 minute under stable electrical and thermal conditions; see operating note 6.
- The RPY97 has been specified in conjunction with a source follower circuit with a typical gain of 0.9. For comparison with the older type dual element detectors, the alternative circuit shown on page 4 should be used. This explains the difference in responsivity levels.

CIRCUIT 1 (RECOMMENDED)

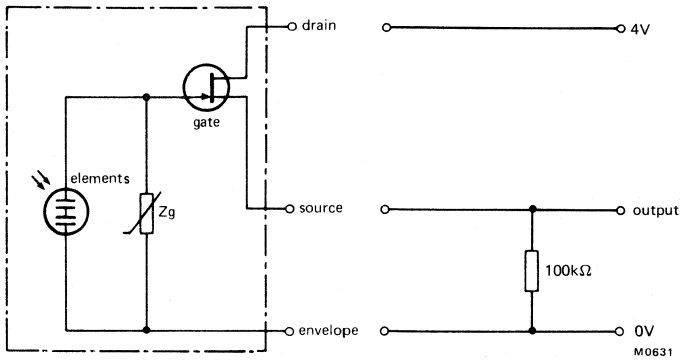

CIRCUIT 2 (ALTERNATIVE, x 5 GAIN)

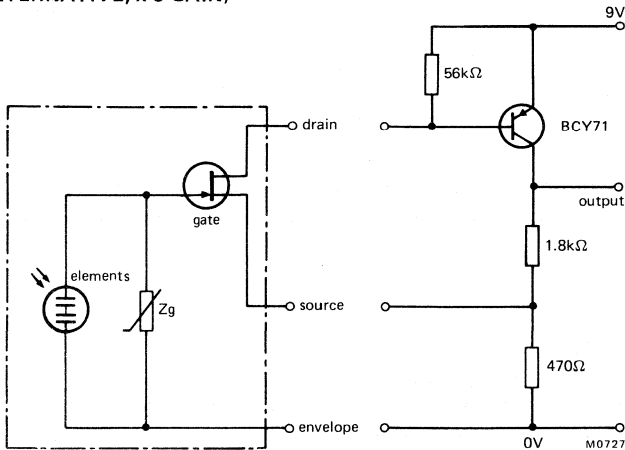

DEFINITIONS

1. Responsivity VW^{-1}

This is the ratio of the r.m.s. signal in volts to the r.m.s. value of the incident, chopped radiant power. The published values of responsivity are qualified by figures in brackets, for example $(10 \mu m, 10)$. The $10 \mu m$ denotes the wavelength of the infrared radiation generating the signal voltage, while the 10 indicates that the radiation is chopped at a frequency of 10 Hz.

2. Noise Equivalent Power (N.E.P.) $WHz^{-1/2}$

This is the r.m.s. value of the incident, chopped radiant power necessary to produce an r.m.s. signal to r.m.s. noise ratio of unity. The r.m.s. noise refers to the value calculated for unit square root bandwidth $VHz^{-1/2}$. As with responsivity the relevant test conditions must be specified, for example $(10 \mu m, 10, 1)$. The $10 \mu m$ is the wavelength of the incident radiation, 10 is the chopping frequency in Hz, and 1 is the bandwidth in Hz.

MECHANICAL AND ENVIRONMENTAL STANDARDS

As part of the Quality Assurance programme, the detectors are assessed at regular intervals against the requirements of the following IEC standards. The frequency of testing and the limits and conditions for the pre- and post-test measurements are based on those stipulated for the CECC 50 000 series of approved transistors.

	Test		Severity	Duration	Note
IEC 68-2-3	Ca	Damp Heat, steady state	+40 °C, 95% RH	168 hours	1
68-2-20	Ta	Solderability	+235 °C, 1.5 mm from header	5 seconds	1
68-2-21	Ub	Lead Fatigue	4 cycles	—	1
68-2-1	Aa	Low Temperature Storage	-55 °C	2000 hours	2
68-2-2	Ba	High Temperature Storage	+85 °C	2000 hours	2
68-2-14	Nb	Change of Temperature	-55 °C to +85 °C	10 cycles	2
68-2-6	Fc (B4)	Vibration, swept frequency	125 Hz to 2 kHz 196 ms ⁻²	2 h in each orientation	2
68-2-7	Ga	Acceleration, steady state	196000 ms ⁻²	60 seconds	2
68-2-27	Ea	Shock	14700 ms ⁻²	3 pulses 6 orientations	2
68-2-20	Tb	Resistance to Solder Heat	+350 °C, 6 mm from header	3 seconds	3

Notes

1. The detectors are checked on a production batch release principle at approximately weekly intervals. This is equivalent to Group B.
2. The detectors are checked at quarterly intervals. This is equivalent to Group C.
3. This is an annual check.

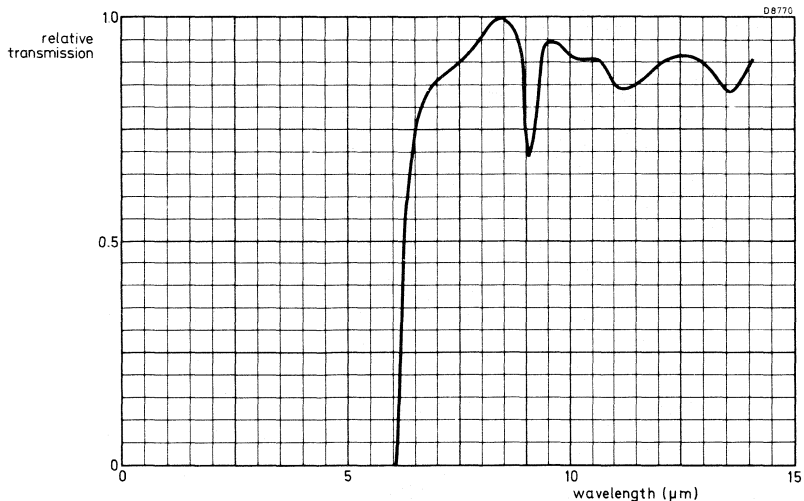

Typical normalized window transmission characteristic

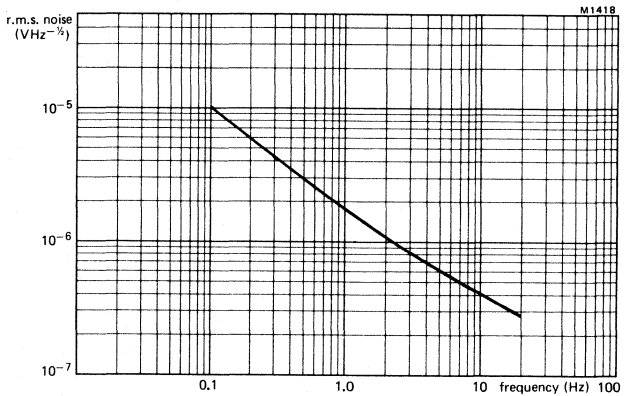
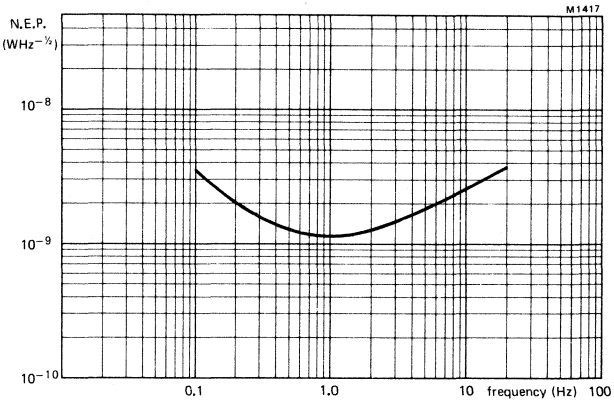
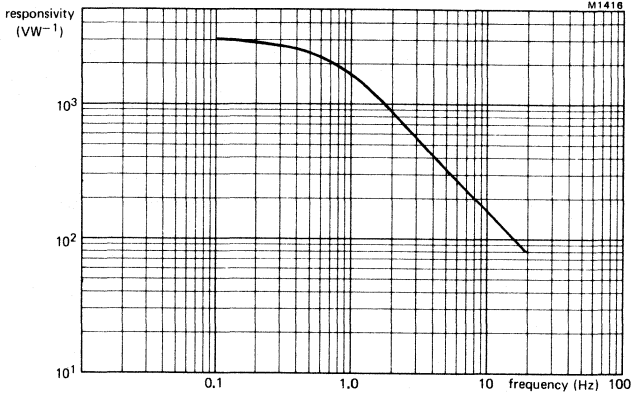

Typical Responsivity, N.E.P., and r.m.s. Noise as functions of Frequency, using recommended circuit 1 (one element screened).

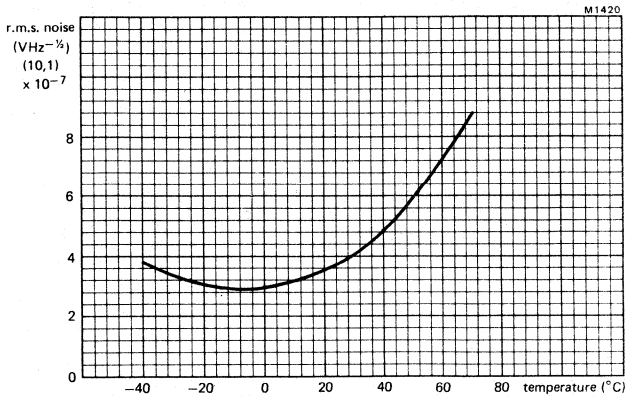
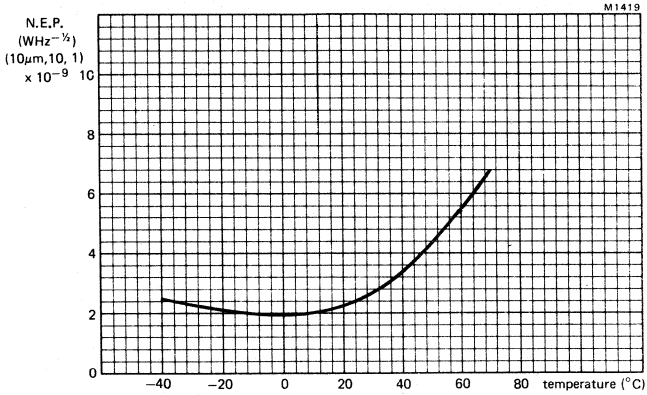
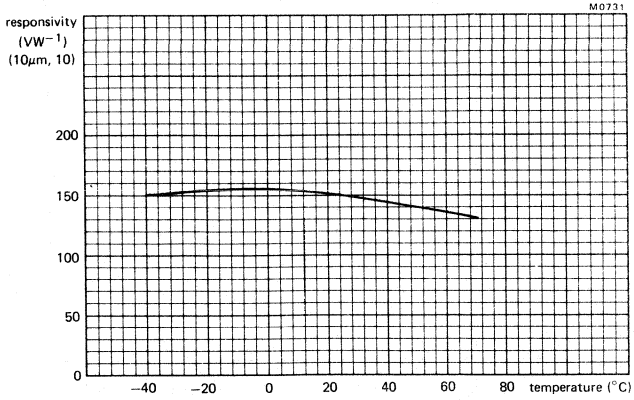

Typical Responsivity, N.E.P., and Noise as functions of Temperature, using recommended circuit 1 (one element screened).

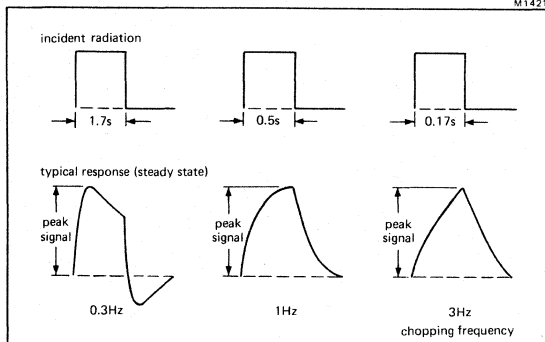

Typical response (steady state) for a given chopping frequency

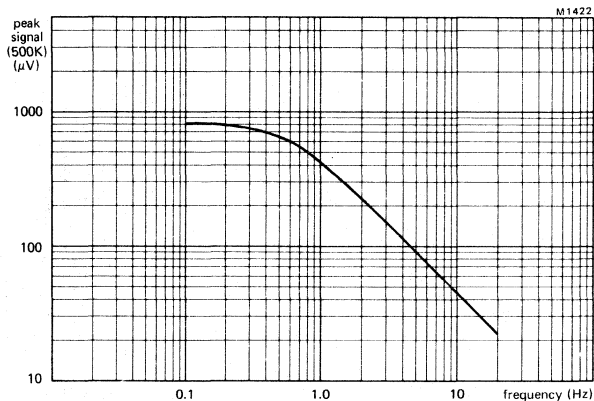

Typical Peak Signal as a function of Frequency
(energy level $25 \mu\text{Wcm}^{-2}$ at the detector and one element screened)

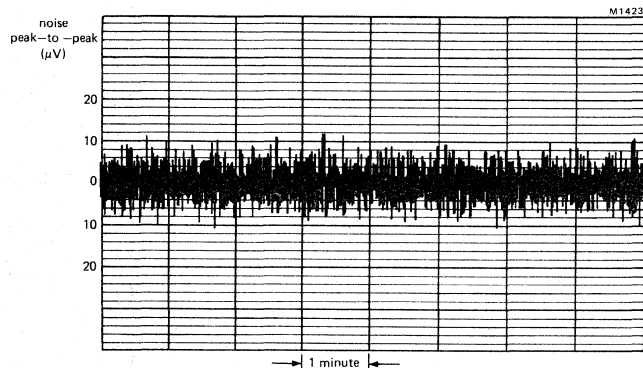

Typical peak-to-peak Noise as a function of Time
(filter bandwidth 0.5 Hz to 5 Hz)

POLAR DIAGRAMS

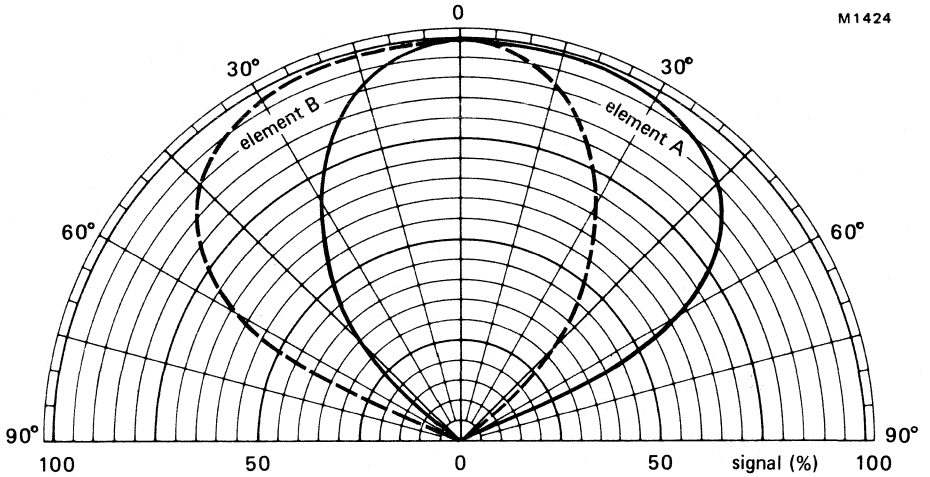

Typical Field of View in x-x plane (see Mechanical Data)

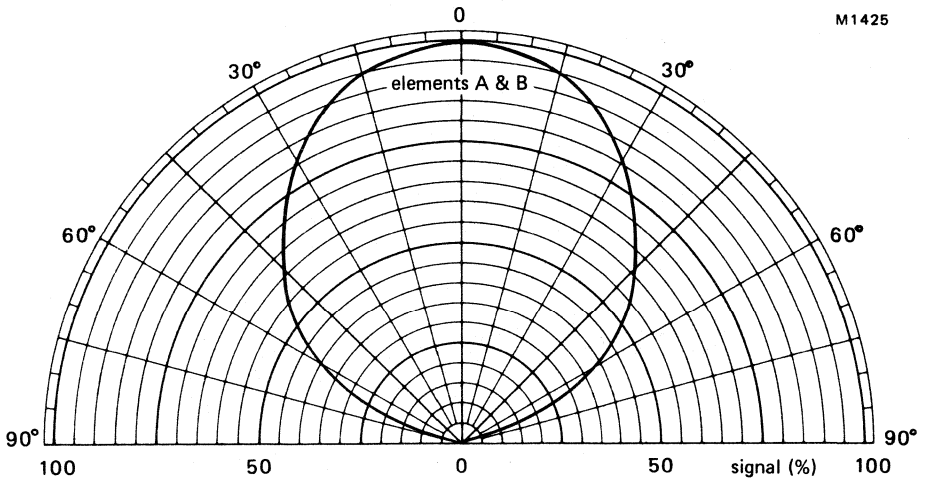

Typical Field of View in y-y plane (see Mechanical Data)

SINGLE ELEMENT PYROELECTRIC INFRARED DETECTOR

This is an infrared sensitive device intended for battery operated passive infrared movement sensors such as intruder alarms in which high grade optics e.g. multi-faceted mirrors or Fresnel lenses are used. The element is combined with a single impedance converting amplifier which is specially designed to function from low voltage supplies with low current consumption. The detector is sealed in a low profile TO-5 can with a window optically coated to restrict response to wavelengths greater than 6.5 μm .

QUICK REFERENCE DATA

Spectral Response		6.5 ± 0.5 to >14	μm
Responsivity (10 μm , 10)	typ.	150	VW^{-1}
Noise Equivalent Power (N.E.P.) (10 μm , 10, 1)	typ.	2.5×10^{-9}	$\text{WHz}^{-1/2}$
Peak signal (500 K, 1)	typ.	460	μV
Noise, peak-to-peak (bandwidth 0.5 Hz to 5 Hz)	typ.	20	μV
Element dimensions	nom.	2×1	mm
Field of View in horizontal plane (x-x)	typ.	110	degrees
Operating voltage	min.	3	V
Optimum operating frequency range		0.1 to 20	Hz

This data must be read in conjunction with GENERAL SAFETY RECOMMENDATIONS – OPTOELECTRONIC DEVICES

MECHANICAL DATA

Dimensions in mm

SOT-49H (TO-5 variant)

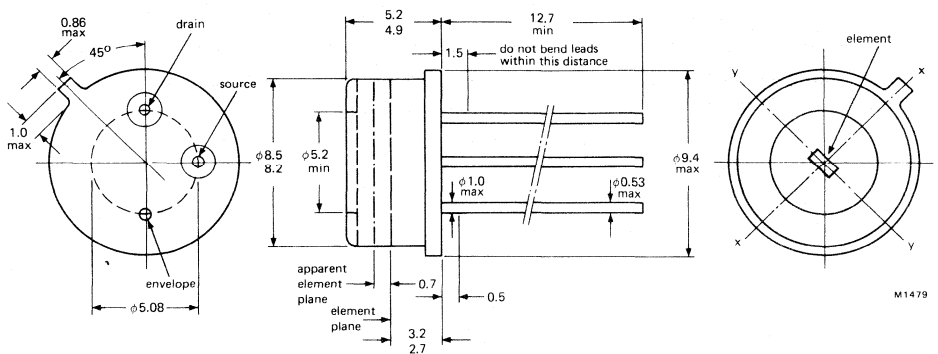

PRODUCT SAFETY

Modern high technology materials have been used in the manufacture of this device to ensure high performance. Some of these materials are toxic in certain circumstances. Mechanical or electrical damage is unlikely to give rise to any hazard, but toxic vapours may be generated if the device is heated to destruction. In the United Kingdom disposal of large quantities should therefore be carried out in accordance with the Deposit of Poisonous Waste Act 1972 and the Control of Pollution Act 1974, or with the latest legislation.

SOLDERING

1. When making soldered connections to the leads, a thermal shunt should be used.
2. It is essential that any mains operated soldering iron used should be both screened and earthed. Failure to observe these precautions may lead to the introduction of line voltages and possible damage to the device.

RATINGS

Limiting values in accordance with the Absolute Maximum System (IEC134).

Supply voltage	max.	30	V
Temperature, operating range		-40 to +70	°C
Temperature, storage range		-55 to +85	°C
Lead soldering temperature, ≥ 6 mm from header, $t_{sld} \leq 3$ s max.		+350	°C

OPERATING CONDITIONS

	min.	max.	
Voltage (operating note 5)	3	10	V
Frequency (operating note 5)	0.1	20	Hz

OPERATING NOTES

1. The case potential must not be allowed to become positive with respect to the other two terminals.
2. It is inadvisable to operate the detector at mains related frequencies.
3. To avoid the possibility of optical microphony, the detector must be firmly mounted.
4. An increase in temperature of the element will produce a positive going signal at the output.
5. The detector will operate outside the quoted range but may have a degraded performance.
6. Before testing, due to the high sensitivity of these detectors, care must be taken to ensure that the devices are allowed to become thermally stable.

CHARACTERISTICS (at $T_{amb} = 22\text{ }^{\circ}\text{C} \pm 3\text{ }^{\circ}\text{C}$ and with recommended circuit)

		min.	typ.	max.	
Spectral Response		6.5 ± 0.5	—	>14	μm
Responsivity* (10 μm , 10)		95	150	—	VW^{-1}
N.E.P. (10 μm , 10, 1)		—	2.5×10^{-9}	—	$\text{WHZ}^{-1/2}$
Peak signal (500 K, 1)	note 1	—	460	—	μV
Noise*, peak-to-peak (bandwidth 0.5 Hz to 5 Hz)	note 2	—	20	45	μV
Field of View (x-x plane, total angle)	note 3	90	110	—	degrees
(y-y plane, total angle)	note 3	90	110	—	degrees
Quiescent current		—	10	—	μA
Element dimensions			2 x 1 nominal		mm

*These parameters are 100% tested with statistical sample quality inspection.

FET Characteristics (at $T_{amb} = 22\text{ }^{\circ}\text{C} \pm 3\text{ }^{\circ}\text{C}$)

		min.	typ.	max.	
Gate-Source Cut-off Voltage $I_D = 0.1\text{ }\mu\text{A}$, $V_{DS} = 6\text{ V}$	$V_{P(GS)}$	-1.2	—	-0.5	V
Transfer Conductance $V_{GS} = 0$, $V_{DS} = 6\text{ V}$, $f = 1\text{ kHz}$	g_{fso}	1.3	—	—	mAV^{-1}

Notes

1. At an energy level of $25\text{ }\mu\text{Wcm}^{-2}$ at the detector.
2. Using low noise filter with 3 dB bandwidth and roll off at 12 dB per octave. Detectors tested for 1 minute under stable electrical and thermal conditions; see operating note 6.
3. Field of view to 50% of the maximum signal level.

RECOMMENDED CIRCUIT

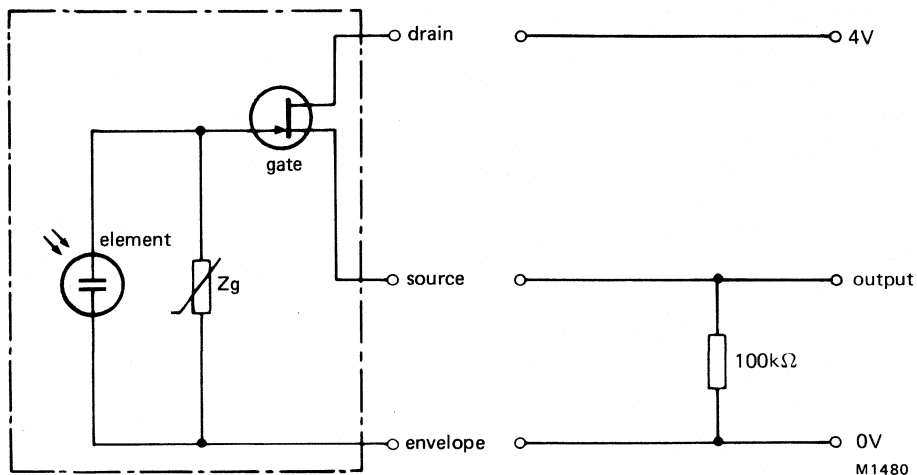

DEFINITIONS

1. Responsivity VW^{-1}

This is the ratio of the r.m.s. signal in volts to the r.m.s. value of the incident, chopped radiant power. The published values of responsivity are qualified by figures in brackets, for example (10 μm , 10). The 10 μm denotes the wavelength of the infrared radiation generating the signal voltage, while the 10 indicates that the radiation is chopped at a frequency of 10 Hz.

2. Noise Equivalent Power (N.E.P.) $WHz^{-1/2}$

This is the r.m.s. value of the incident, chopped radiant power necessary to produce an r.m.s. signal to r.m.s. noise ratio of unity. The r.m.s. noise refers to the value calculated for unit square root bandwidth $VHz^{-1/2}$. As with responsivity the relevant test conditions must be specified, for example (10 μm , 10, 1). The 10 μm is the wavelength of the incident radiation, 10 is the chopping frequency in Hz, and 1 is the bandwidth in Hz.

MECHANICAL AND ENVIRONMENTAL STANDARDS

As part of the Quality Assurance programme, the detectors are assessed at regular intervals against the requirements of the following IEC standards. The frequency of testing and the limits and conditions for the pre- and post-test measurements are based on those stipulated for the CECC 50 000 series of approved transistors.

	Test		Severity	Duration	Note
IEC 68-2-3	Ca	Damp Heat, steady state	+40 °C, 95% RH	168 hours	1
68-2-20	Ta	Solderability	+235 °C, 1.5 mm from header	5 seconds	1
68-2-21	Ub	Lead Fatigue	4 cycles	—	1
68-2-1	Aa	Low Temperature Storage	-55 °C	2000 hours	2
68-2-2	Ba	High Temperature Storage	+85 °C	2000 hours	2
68-2-14	Nb	Change of Temperature	-55 °C to +85 °C	10 cycles	2
68-2-6	Fc (B4)	Vibration, swept frequency	125 Hz to 2 kHz 196 ms ⁻²	2 h in each orientation	2
68-2-7	Ga	Acceleration, steady state	196000 ms ⁻²	60 seconds	2
68-2-27	Ea	Shock	14700 ms ⁻²	3 pulses 6 orientations	2
68-2-20	Tb	Resistance to Solder Heat	+350 °C, 6 mm from header	3 seconds	3

Notes

1. The detectors are checked on a production batch release principle at approximately weekly intervals. This is equivalent to Group B.
2. The detectors are checked at quarterly intervals. This is equivalent to Group C.
3. This is an annual check.

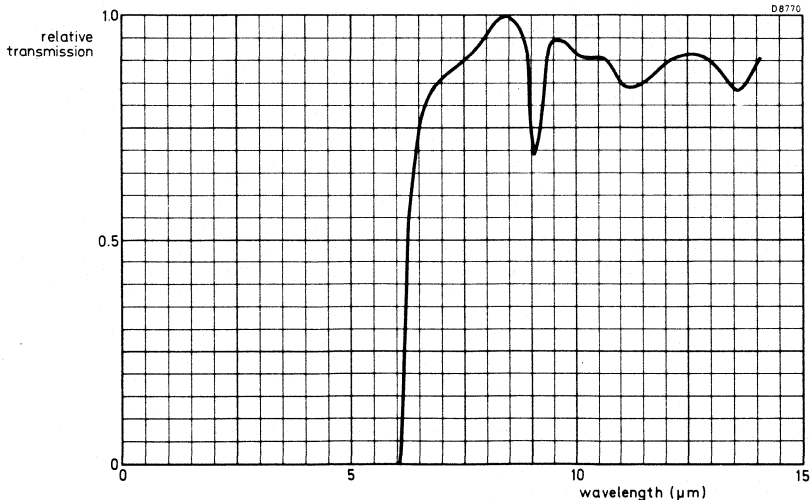

Typical normalized window transmission characteristic

M1421

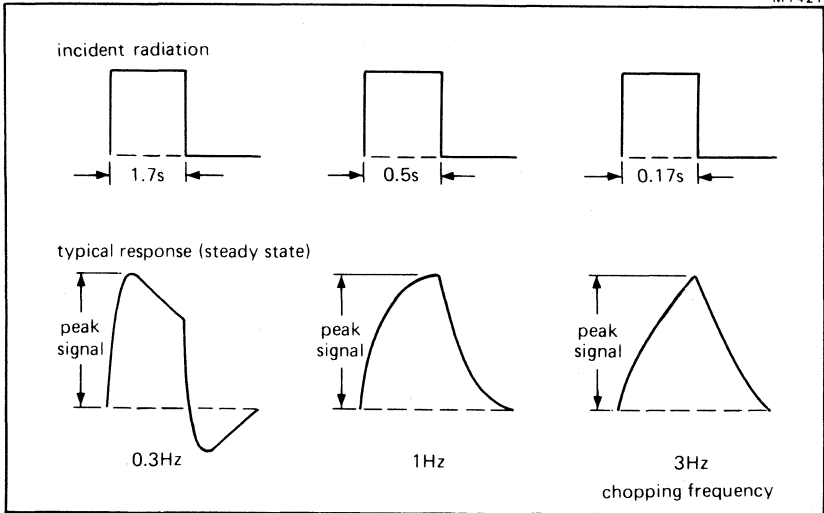

Typical response (steady state) for a given chopping frequency

M1426

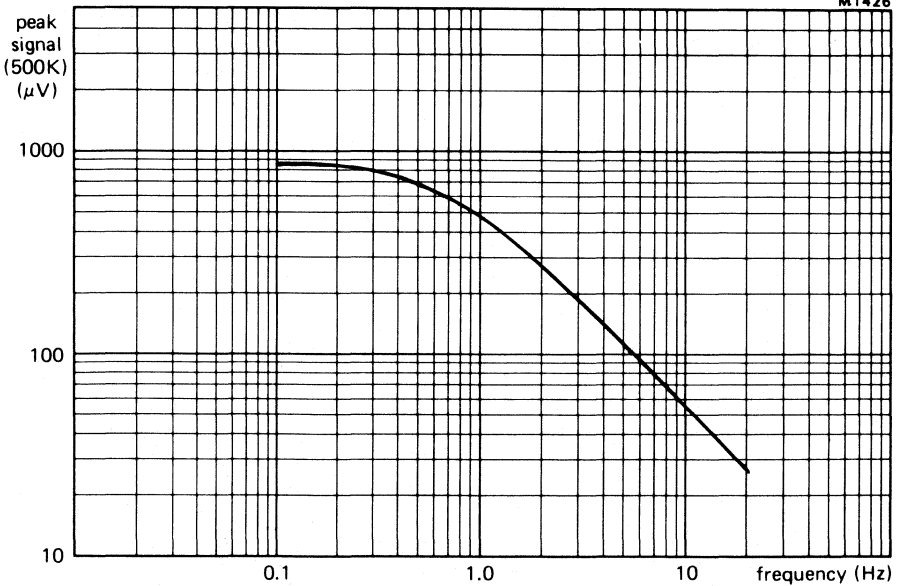

Typical peak Signal as a function of Frequency
(energy level $25 \mu\text{Wcm}^{-2}$ at the detector)

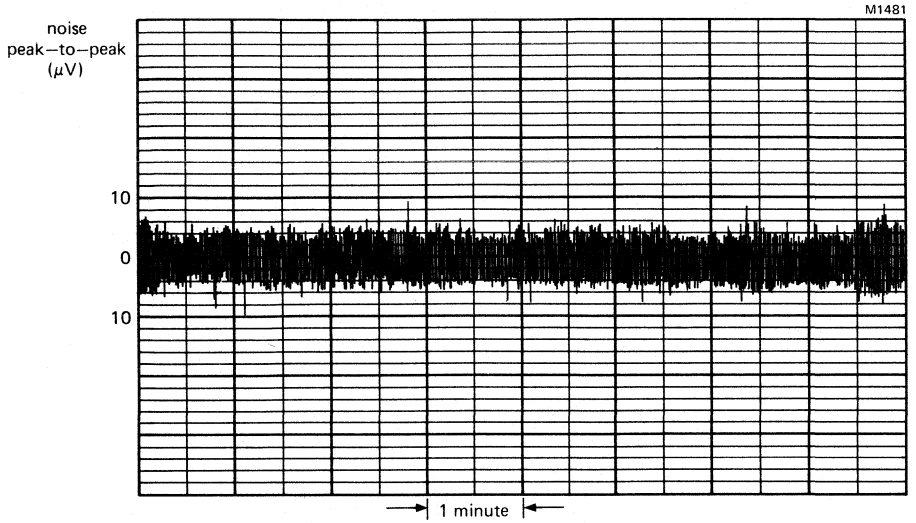

Typical peak-to-peak Noise as a function of Time
(filter bandwidth 0.5 Hz to 5 Hz)

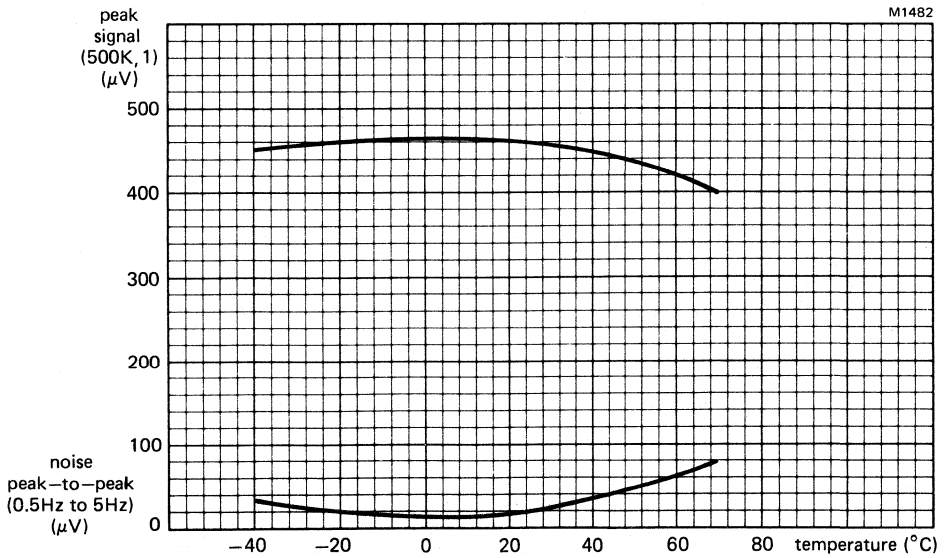

Typical peak Signal and peak-to-peak Noise
as functions of Temperature
(peak Signal energy level, $25 \mu\text{Wcm}^{-2}$ at the detector)

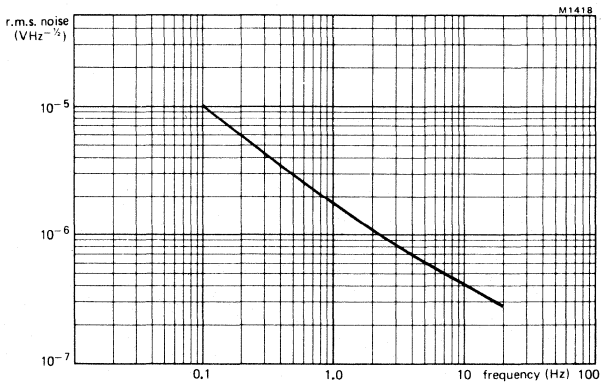
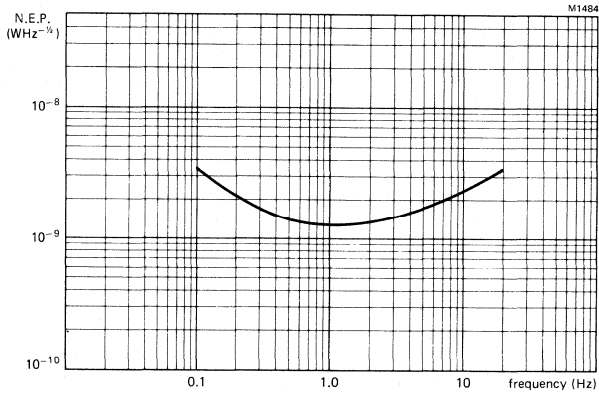
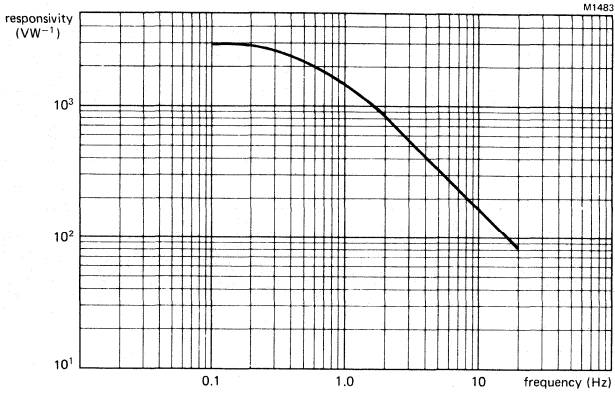

Typical Responsivity, N.E.P., and r.m.s. Noise as functions of Frequency, using recommended circuit.

POLAR DIAGRAMS

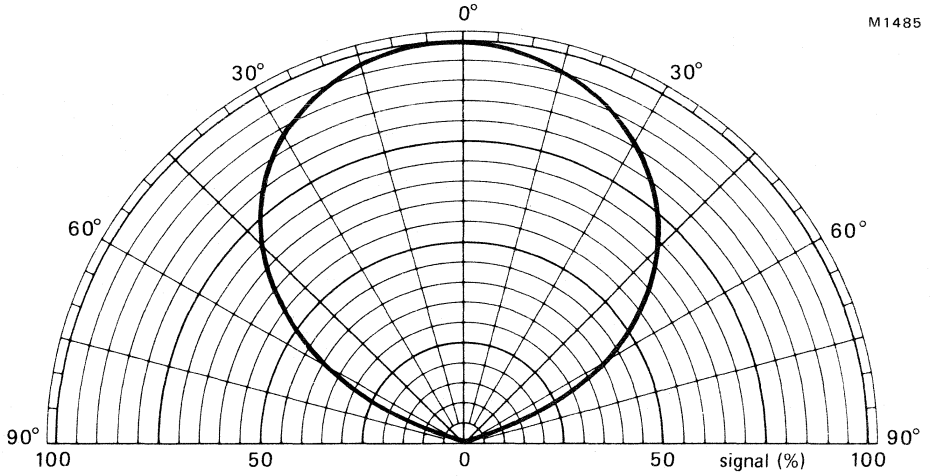

Typical Field of View in x-x plane (see Mechanical Data)

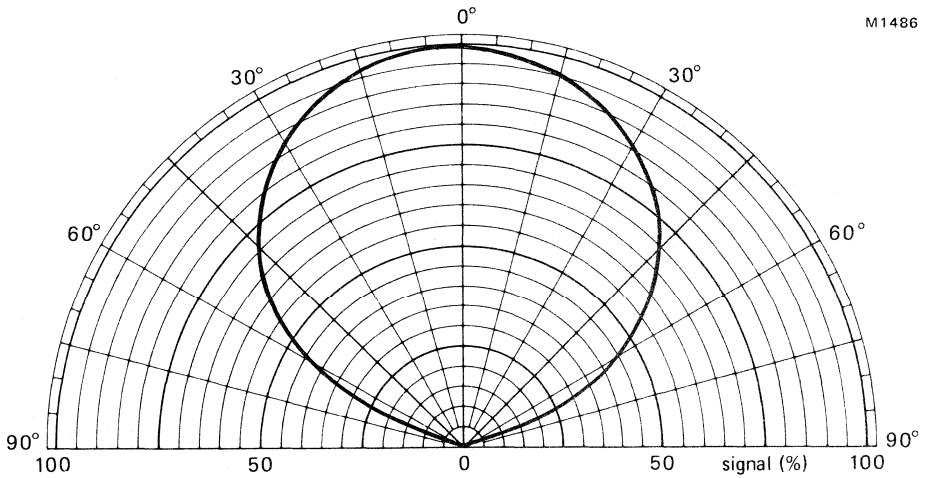

Typical Field of View in y-y plane (see Mechanical Data)

SINGLE ELEMENT PYROELECTRIC INFRARED DETECTOR

This is an infrared sensitive device intended for battery operated passive infrared movement sensors such as intruder alarms in which medium grade optics are used. The element is combined with a single impedance converting amplifier which is specially designed to function from low voltage supplies with low current consumption. The detector is sealed in a low profile TO-5 can with a window optically coated to restrict response to wavelengths greater than 6.5 μm .

QUICK REFERENCE DATA

Spectral Response		6.5 ± 0.5 to >14	μm
Responsivity (10 μm , 10)	typ.	150	VW^{-1}
Noise Equivalent Power (N.E.P.) (10 μm , 10, 1)	typ.	3.8×10^{-9}	$\text{WHz}^{-1/2}$
Peak signal (500 K, 1)	typ.	460	μV
Noise, peak-to-peak (bandwidth 0.5 Hz to 5 Hz)	typ.	18	μV
Element dimensions	nom.	2×1.5	mm
Field of View in horizontal plane (x-x)	typ.	110	degrees
Operating voltage	min.	3	
Optimum operating frequency range		0.1 to 20	Hz

This data must be read in conjunction with GENERAL SAFETY RECOMMENDATIONS – OPTOELECTRONIC DEVICES

MECHANICAL DATA

Dimensions in mm

SOT-49H (TO-5 variant)

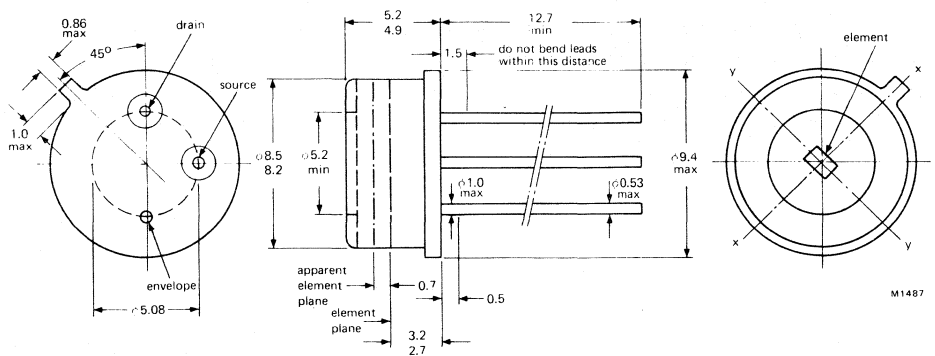

PRODUCT SAFETY

Modern high technology materials have been used in the manufacture of this device to ensure high performance. Some of these materials are toxic in certain circumstances. Mechanical or electrical damage is unlikely to give rise to any hazard, but toxic vapours may be generated if the device is heated to destruction. In the United Kingdom disposal of large quantities should therefore be carried out in accordance with the Deposit of Poisonous Waste Act 1972 and the Control of Pollution Act 1974, or with the latest legislation.

SOLDERING

1. When making soldered connections to the leads, a thermal shunt should be used.
2. It is essential that any mains operated soldering iron used should be both screened and earthed. Failure to observe these precautions may lead to the introduction of line voltages and possible damage to the device.

RATINGS

Limiting values in accordance with the Absolute Maximum System (IEC134).

Supply voltage	max.	30	V
Temperature, operating range		-40 to +70	°C
Temperature, storage range		-55 to +85	°C
Lead soldering temperature, ≥ 6 mm from header, $t_{sld} \leq 3$ s max.		+350	°C

OPERATING CONDITIONS

	min.	max.	
Voltage (operating note 5)	3	10	V
Frequency (operating note 5)	0.1	20	Hz

OPERATING NOTES

1. The case potential must not be allowed to become positive with respect to the other two terminals.
2. It is inadvisable to operate the detector at mains related frequencies.
3. To avoid the possibility of optical microphony, the detector must be firmly mounted.
4. An increase in temperature of the element will produce a positive going signal at the output.
5. The detector will operate outside the quoted range but may have a degraded performance.
6. Before testing, due to the high sensitivity of these detectors, care must be taken to ensure that the devices are allowed to become thermally stable.

CHARACTERISTICS (at $T_{amb} = 22\text{ }^{\circ}\text{C} \pm 3\text{ }^{\circ}\text{C}$ and with recommended circuit)

		min.	typ.	max.	
Spectral Response		6.5 ± 0.5	—	>14	μm
Responsivity* (10 μm , 10)		65	100	—	VW^{-1}
N.E.P. (10 μm , 10, 1)		—	3.8×10^{-9}	—	WHz^{-1}
Peak signal (500 K, 1)	note 1	—	460	—	μV
Noise*, peak-to-peak (bandwidth 0.5 Hz to 5 Hz)	note 2	—	18	45	μV
Field of View (x-x plane, total angle)	note 3	90	110	—	degrees
(y-y plane, total angle)	note 3	90	110	—	degrees
Quiescent current		—	10	—	μA
Element dimensions		2 x 1.5 nominal			mm

*These parameters are 100% tested with statistical sample quality inspection.

FET Characteristics (at $T_{amb} = 22\text{ }^{\circ}\text{C} \pm 3\text{ }^{\circ}\text{C}$)

		min.	typ.	max.	
Gate-Source Cut-off Voltage $I_D = 0.1\text{ }\mu\text{A}$, $V_{DS} = 6\text{ V}$	$V_{P(GS)}$	-1.2	—	-0.5	V
Transfer Conductance $V_{GS} = 0$, $V_{DS} = 6\text{ V}$, $f = 1\text{ kHz}$	g_{fso}	1.3	—	—	mAV^{-1}

Notes

1. At an energy level of $25\text{ }\mu\text{Wcm}^{-2}$ at the detector.
2. Using low noise filter with 3 dB bandwidth and roll off at 12 dB per octave. Detectors tested for 1 minute under stable electrical and thermal conditions; see operating note 6.
3. Field of view to 50% of the maximum signal level.

RECOMMENDED CIRCUIT

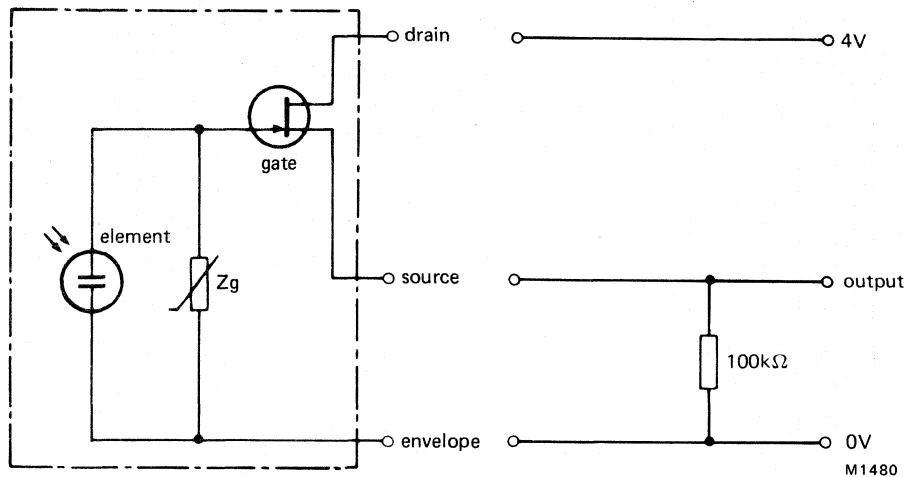

M1480

DEFINITIONS

1. Responsivity VW^{-1}

This is the ratio of the r.m.s. signal in volts to the r.m.s. value of the incident, chopped radiant power. The published values of responsivity are qualified by figures in brackets, for example (10 μm , 10). The 10 μm denotes the wavelength of the infrared radiation generating the signal voltage, while the 10 indicates that the radiation is chopped at a frequency of 10 Hz.

2. Noise Equivalent Power (N.E.P.) $WHz^{-1/2}$

This is the r.m.s. value of the incident, chopped radiant power necessary to produce an r.m.s. signal to r.m.s. noise ratio of unity. The r.m.s. noise refers to the value calculated for unit square root bandwidth $VHz^{-1/2}$. As with responsivity the relevant test conditions must be specified, for example (10 μm , 10, 1). The 10 μm is the wavelength of the incident radiation, 10 is the chopping frequency in Hz, and 1 is the bandwidth in Hz.

MECHANICAL AND ENVIRONMENTAL STANDARDS

As part of the Quality Assurance programme, the detectors are assessed at regular intervals against the requirements of the following IEC standards. The frequency of testing and the limits and conditions for the pre- and post-test measurements are based on those stipulated for the CECC 50 000 series of approved transistors.

	Test		Severity	Duration	Note
IEC 68-2-3	Ca	Damp Heat, steady state	+40 °C, 95% RH	168 hours	1
68-2-20	Ta	Solderability	+235 °C, 1.5 mm from header	5 seconds	1
68-2-21	Ub	Lead Fatigue	4 cycles	—	1
68-2-1	Aa	Low Temperature Storage	-55 °C	2000 hours	2
68-2-2	Ba	High Temperature Storage	+85 °C	2000 hours	2
68-2-14	Nb	Change of Temperature	-55 °C to +85 °C	10 cycles	2
68-2-6	Fc (B4)	Vibration, swept frequency	125 Hz to 2 kHz 196 ms ⁻²	2 h in each orientation	2
68-2-7	Ga	Acceleration, steady state	196000 ms ⁻²	60 seconds	2
68-2-27	Ea	Shock	14700 ms ⁻²	3 pulses 6 orientations	2
68-2-20	Tb	Resistance to Solder Heat	+350 °C, 6 mm from header	3 seconds	3

Notes

1. The detectors are checked on a production batch release principle at approximately weekly intervals. This is equivalent to Group B.
2. The detectors are checked at quarterly intervals. This is equivalent to Group C.
3. This is an annual check.

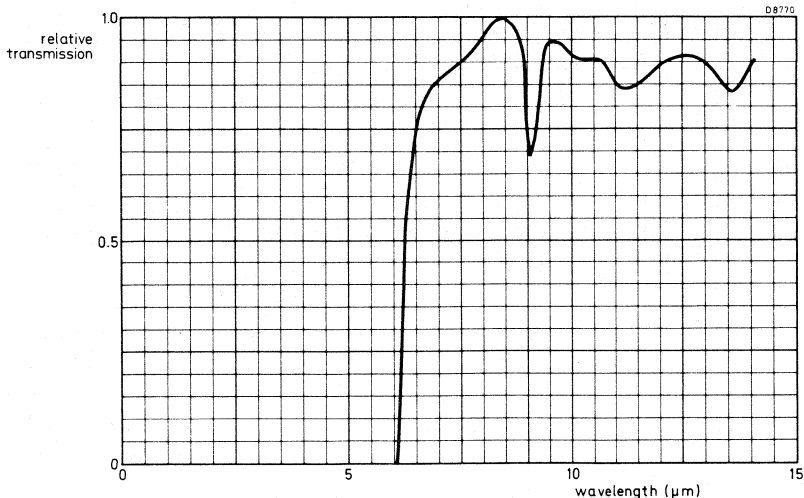

Typical normalized window transmission characteristic

M1421

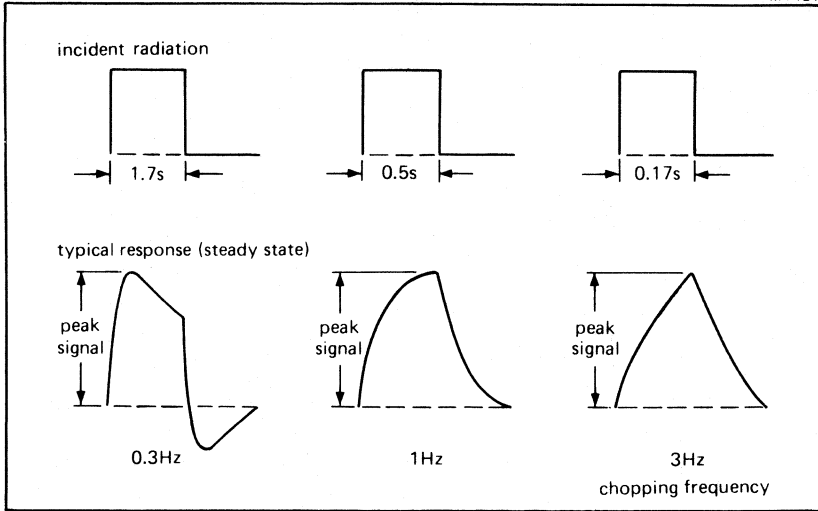

Typical response (steady state) for a given chopping frequency

M1426

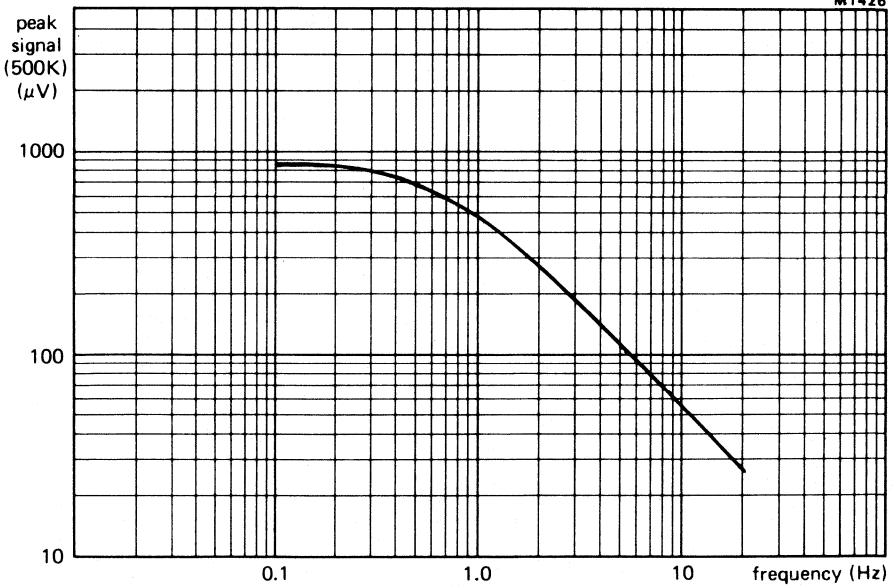

Typical peak Signal as a function of Frequency
(energy level $25 \mu Wcm^{-2}$ at the detector)

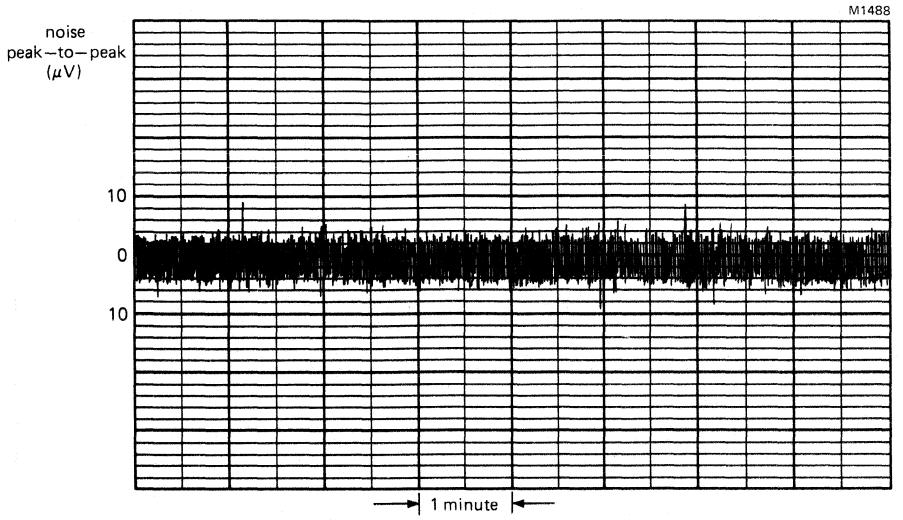

Typical peak-to-peak Noise as a function of Time
(filter bandwidth 0.5 Hz to 5 Hz)

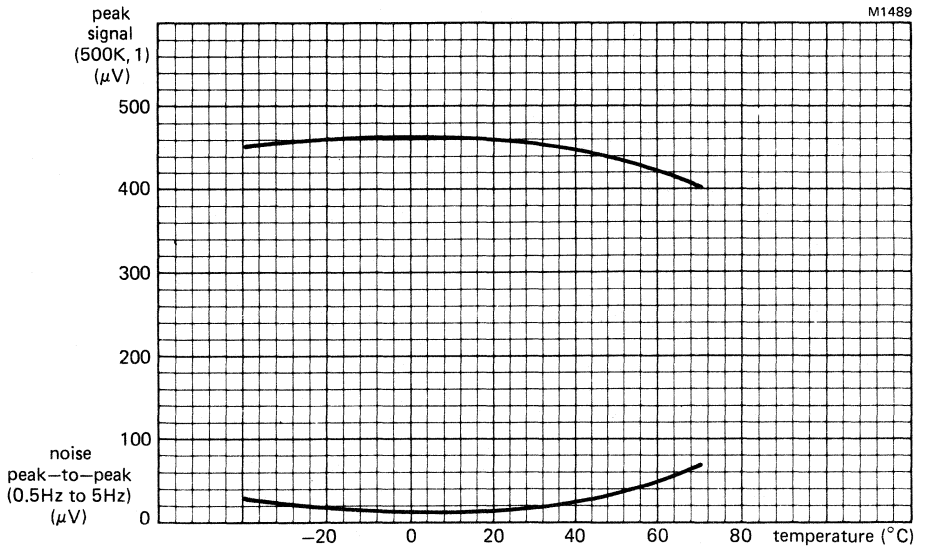

Typical peak Signal and peak-to-peak Noise
as functions of Temperature
(peak Signal energy level, $25 \mu\text{Wcm}^{-2}$ at the detector)

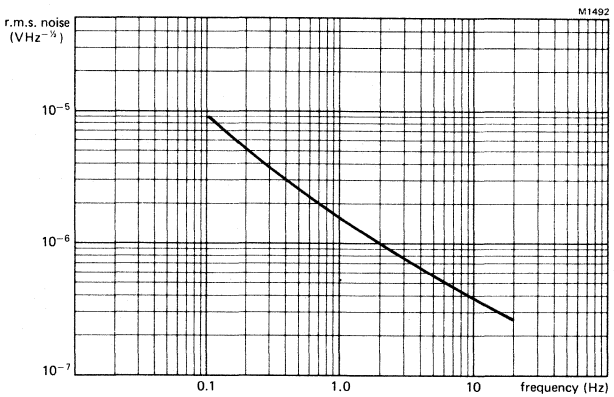
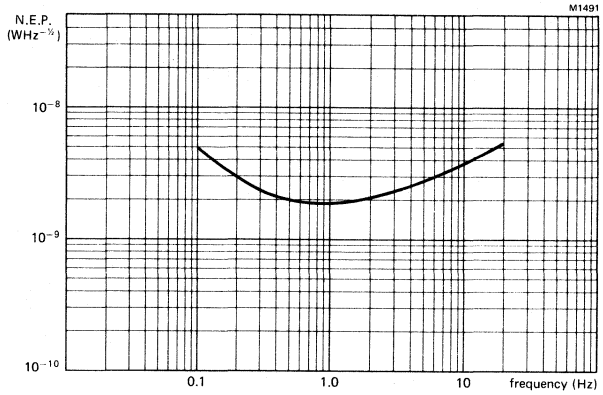
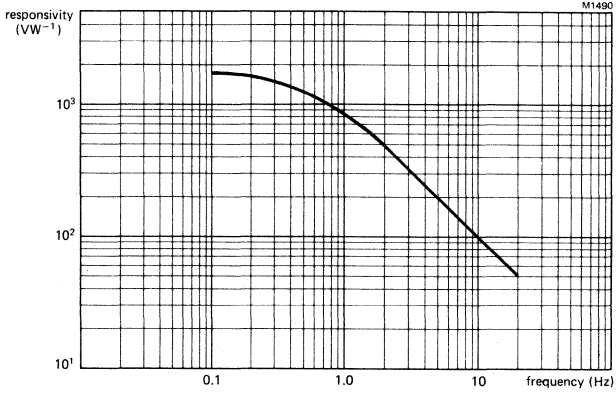

Typical Responsivity, N.E.P., and r.m.s. Noise as functions of Frequency, using recommended circuit.

POLAR DIAGRAMS

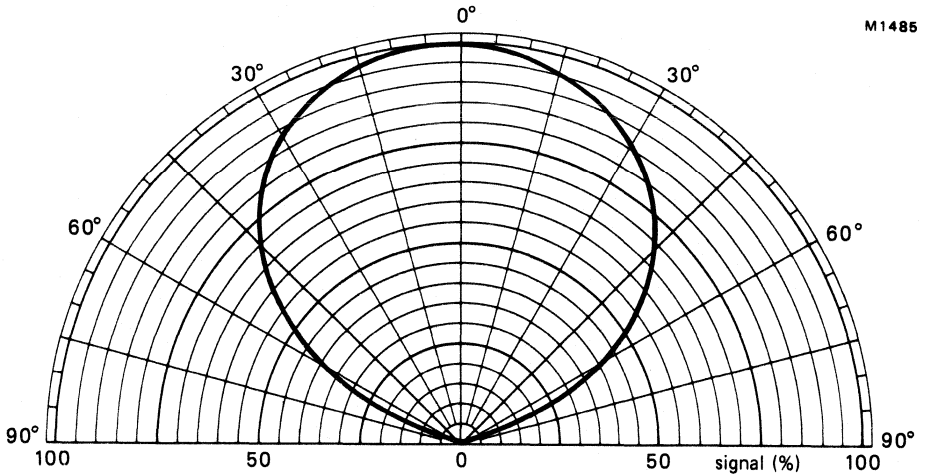

Typical Field of View in x-x plane (see Mechanical Data)

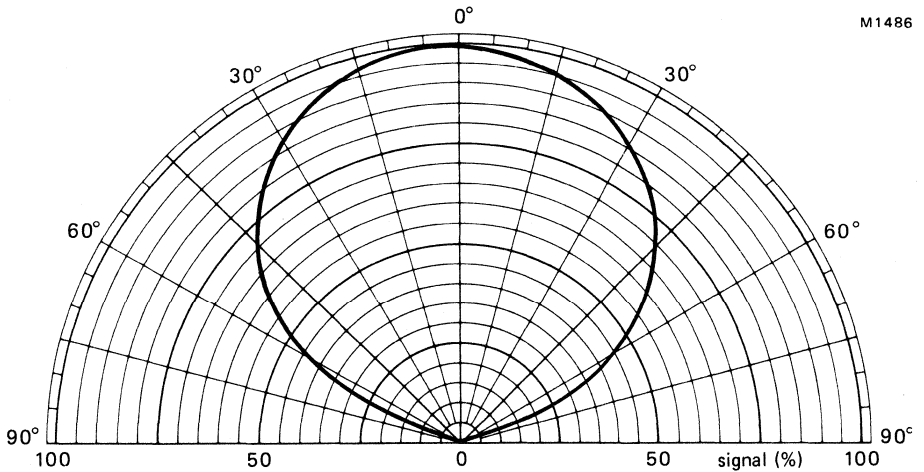

Typical Field of View in y-y plane (see Mechanical Data)

PRODUCT SAFETY

Modern high technology materials have been used in the manufacture of this device to ensure high performance. Some of these materials are toxic in certain circumstances. Mechanical or electrical damage is unlikely to give rise to any hazard, but toxic vapours may be generated if the device is heated to destruction. In the United Kingdom disposal of large quantities should therefore be carried out in accordance with the Deposit of Poisonous Waste Act 1972 and the Control of Pollution Act 1974, or with the latest legislation.

SOLDERING

1. When making soldered connections to the leads, a thermal shunt should be used.
2. It is essential that any mains operated soldering iron used should be both screened and earthed. Failure to observe these precautions may lead to the introduction of line voltages and possible damage to the device.

RATINGS

Limiting values in accordance with the Absolute Maximum System (IEC134).

Supply voltage	max.	30	V
Temperature, operating range		-40 to +70	°C
Temperature, storage range		-55 to +85	°C
Lead soldering temperature, ≥ 6 mm from header, $t_{sld} \leq 3$ s max.		+350	°C

OPERATING CONDITIONS

	min.	max.	
Voltage (operating note 5)	3	10	V
Frequency (operating note 5)	0.1	20	Hz

OPERATING NOTES

1. The case potential must not be allowed to become positive with respect to the other two terminals.
2. It is inadvisable to operate the detector at mains related frequencies.
3. To avoid the possibility of optical microphony, the detector must be firmly mounted.
4. An increase in temperature of the element will produce a positive going signal at the output.
5. The detector will operate outside the quoted range but may have a degraded performance.
6. Before testing, due to the high sensitivity of these detectors, care must be taken to ensure that the devices are allowed to become thermally stable.

CHARACTERISTICS (at $T_{amb} = 22\text{ }^{\circ}\text{C} \pm 3\text{ }^{\circ}\text{C}$ and with recommended circuit)

		min.	typ.	max.	
Spectral Response		6.5 ± 0.5	—	>14	μm
Responsivity* (10 μm , 10)		50	75	—	VW^{-1}
N.E.P. (10 μm , 10, 1)		—	5.0×10^{-9}	—	WHz^{-1}
Peak signal (500 K, 1)	note 1	—	460	—	μV
Noise*, peak-to-peak (bandwidth 0.5 Hz to 5 Hz)	note 2	—	15	45	μV
Field of View (x-x plane, total angle)	note 3	90	110	—	degrees
(y-y plane, total angle)	note 3	90	110	—	degrees
Quiescent current		—	10	—	μA
Element dimensions		2 x 2 nominal			mm

*These parameters are 100% tested with statistical sample quality inspection.

FET Characteristics (at $T_{amb} = 22\text{ }^{\circ}\text{C} \pm 3\text{ }^{\circ}\text{C}$)

		min.	typ.	max.	
Gate-Source Cut-off Voltage					
$I_D = 0.1\text{ }\mu\text{A}$, $V_{DS} = 6\text{ V}$	$V_{P(GS)}$	-1.2	—	-0.5	V
Transfer Conductance					
$V_{GS} = 0$, $V_{DS} = 6\text{ V}$, $f = 1\text{ kHz}$	g_{fso}	1.3	—	—	mAV^{-1}

Notes

1. At an energy level of $25\text{ }\mu\text{Wcm}^{-2}$ at the detector.
2. Using low noise filter with 3 dB bandwidth and roll off at 12 dB per octave. Detectors tested for 1 minute under stable electrical and thermal conditions; see operating note 6.
3. Field of view to 50% of the maximum signal level.

RECOMMENDED CIRCUIT

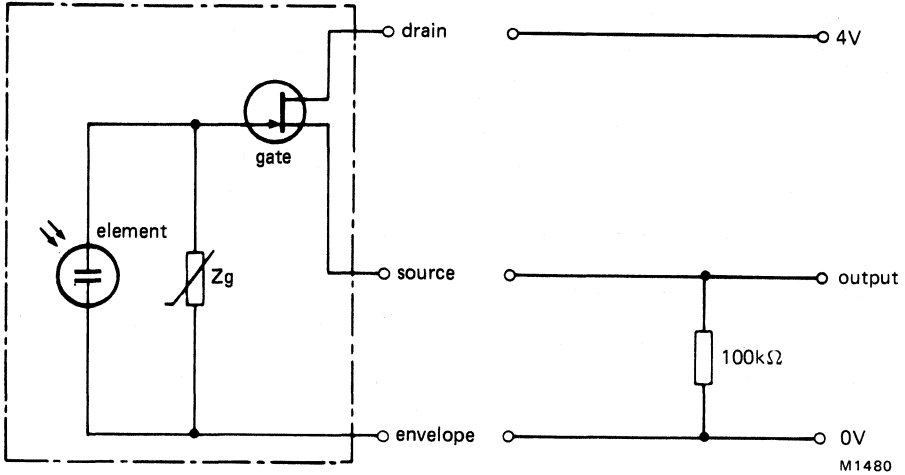

DEFINITIONS

1. Responsivity VW^{-1}
 This is the ratio of the r.m.s. signal in volts to the r.m.s. value of the incident, chopped radiant power. The published values of responsivity are qualified by figures in brackets, for example (10 μm , 10). The 10 μm denotes the wavelength of the infrared radiation generating the signal voltage, while the 10 indicates that the radiation is chopped at a frequency of 10 Hz.
2. Noise Equivalent Power (N.E.P.) $WHz^{-1/2}$
 This is the r.m.s. value of the incident, chopped radiant power necessary to produce an r.m.s. signal to r.m.s. noise ratio of unity. The r.m.s. noise refers to the value calculated for unit square root bandwidth $VHz^{-1/2}$. As with responsivity the relevant test conditions must be specified, for example (10 μm , 10, 1). The 10 μm is the wavelength of the incident radiation, 10 is the chopping frequency in Hz, and 1 is the bandwidth in Hz.

MECHANICAL AND ENVIRONMENTAL STANDARDS

As part of the Quality Assurance programme, the detectors are assessed at regular intervals against the requirements of the following IEC standards. The frequency of testing and the limits and conditions for the pre- and post-test measurements are based on those stipulated for the CECC 50 000 series of approved transistors.

	Test		Severity	Duration	Note
IEC 68-2-3	Ca	Damp Heat, steady state	+40 °C, 95% RH	168 hours	1
68-2-20	Ta	Solderability	+235 °C, 1.5 mm from header	5 seconds	1
68-2-21	Ub	Lead Fatigue	4 cycles	—	1
68-2-1	Aa	Low Temperature Storage	-55 °C	2000 hours	2
68-2-2	Ba	High Temperature Storage	+85 °C	2000 hours	2
68-2-14	Nb	Change of Temperature	-55 °C to +85 °C	10 cycles	2
68-2-6	Fc (B4)	Vibration, swept frequency	125 Hz to 2 kHz 196 ms ⁻²	2 h in each orientation	2
68-2-7	Ga	Acceleration, steady state	196000 ms ⁻²	60 seconds	2
68-2-27	Ea	Shock	14700 ms ⁻²	3 pulses 6 orientations	2
68-2-20	Tb	Resistance to Solder Heat	+350 °C, 6 mm from header	3 seconds	3

Notes

1. The detectors are checked on a production batch release principle at approximately weekly intervals. This is equivalent to Group B.
2. The detectors are checked at quarterly intervals. This is equivalent to Group C.
3. This is an annual check.

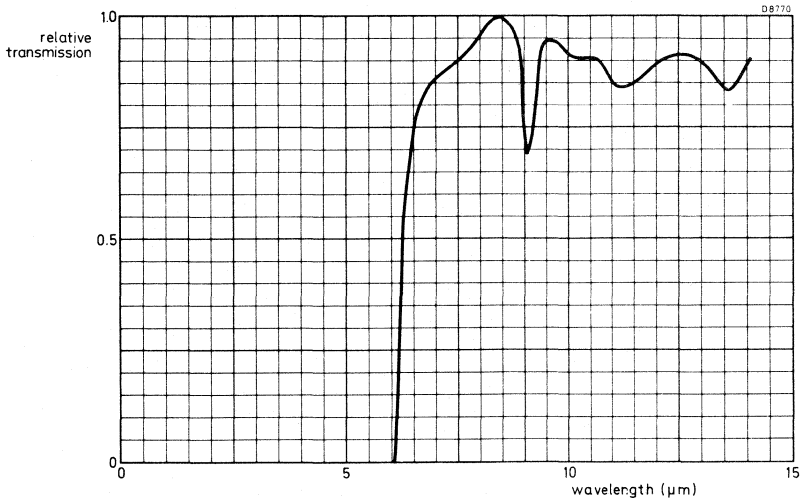

Typical normalized window transmission characteristic

M1421

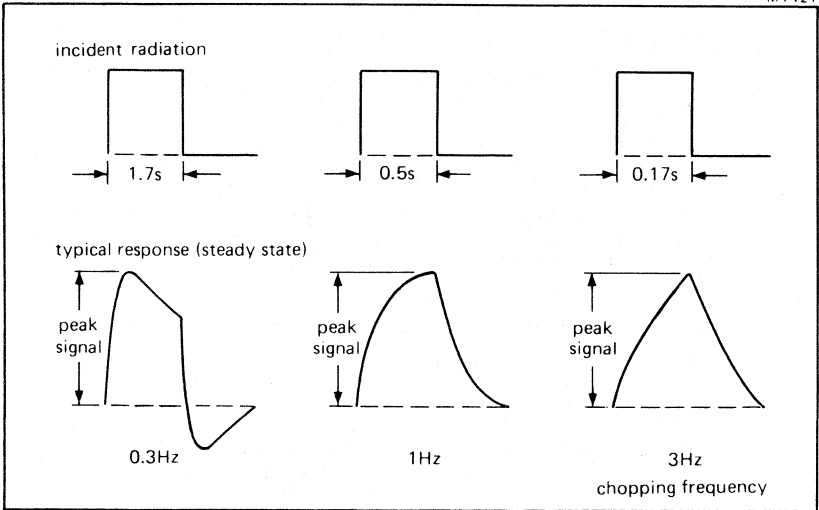

Typical response (steady state) for a given chopping frequency

M1426

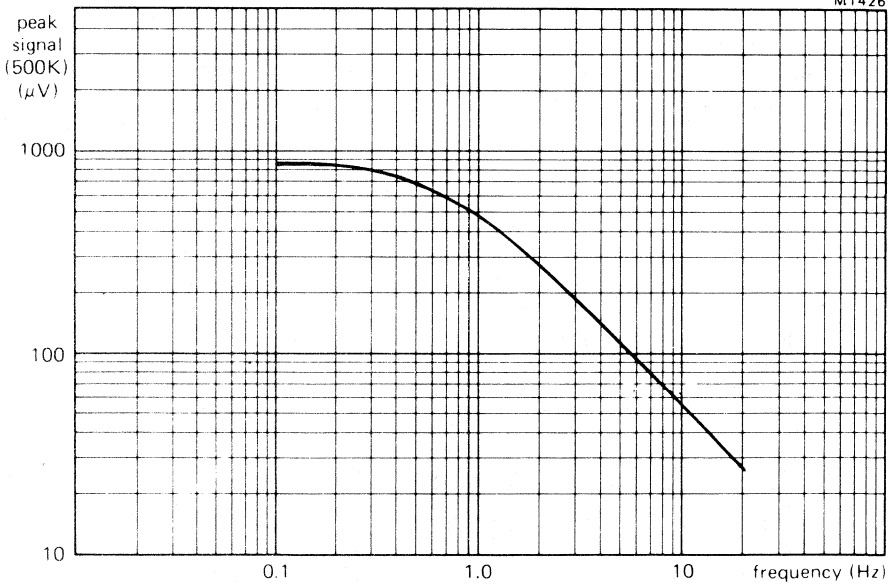

Typical peak Signal as a function of Frequency
(energy level $25 \mu\text{Wcm}^{-2}$ at the detector)

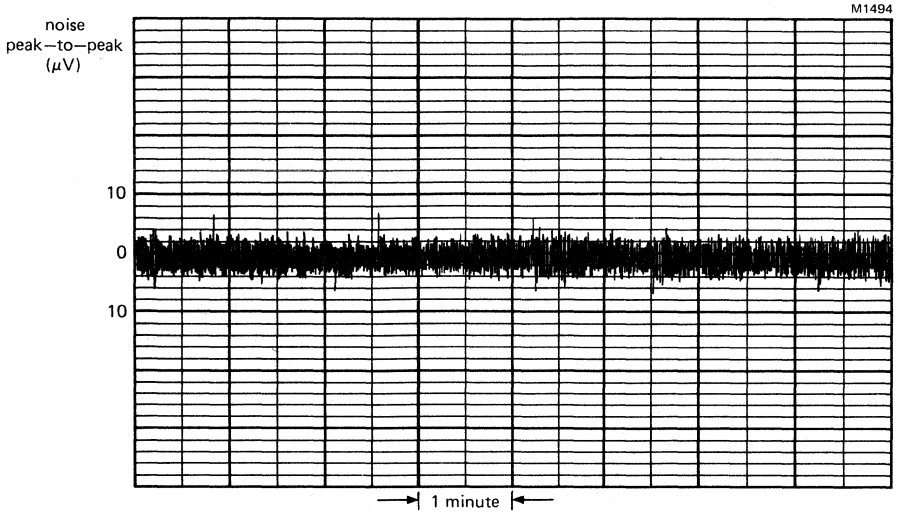

Typical peak-to-peak Noise as a function of Time
(filter bandwidth 0.5 Hz to 5 Hz)

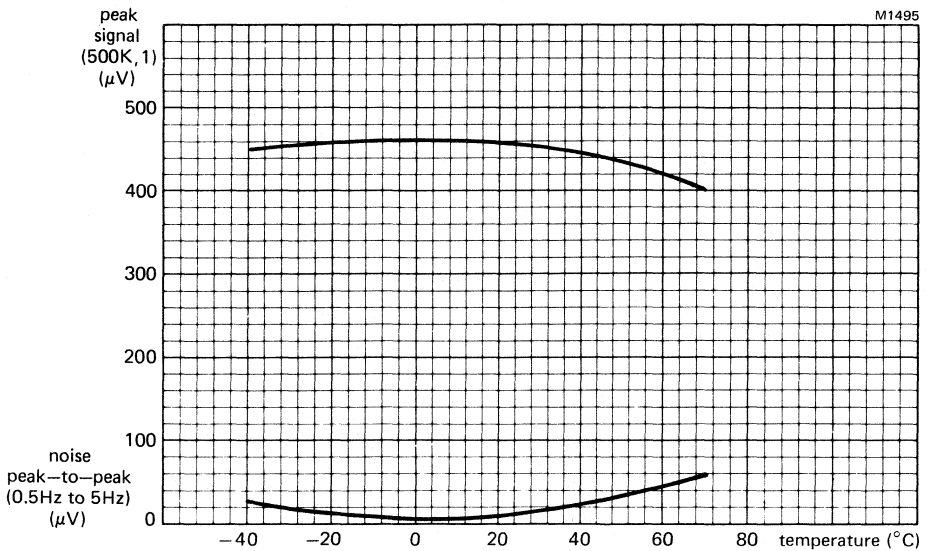

Typical peak Signal and peak-to-peak Noise
as functions of Temperature
(peak Signal energy level, $25 \mu\text{Wcm}^{-2}$ at the detector)

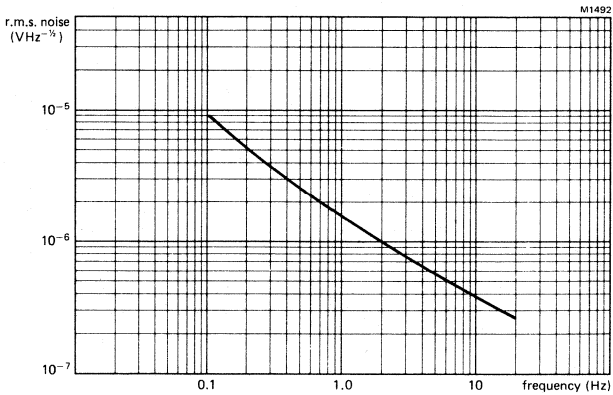
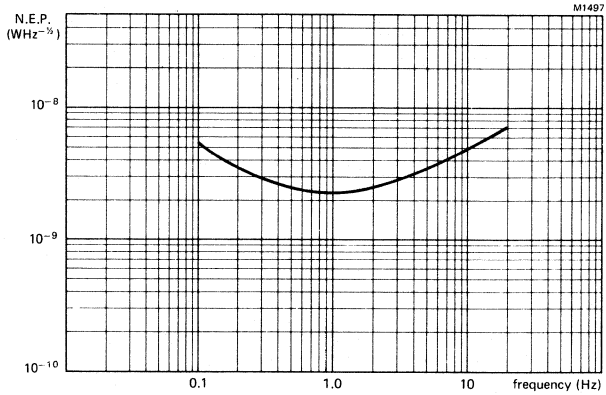
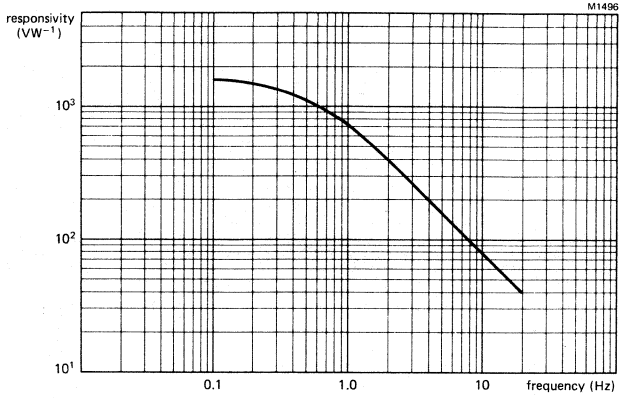

Typical Responsivity, N.E.P., and r.m.s. Noise as functions of Frequency, using recommended circuit.

POLAR DIAGRAMS

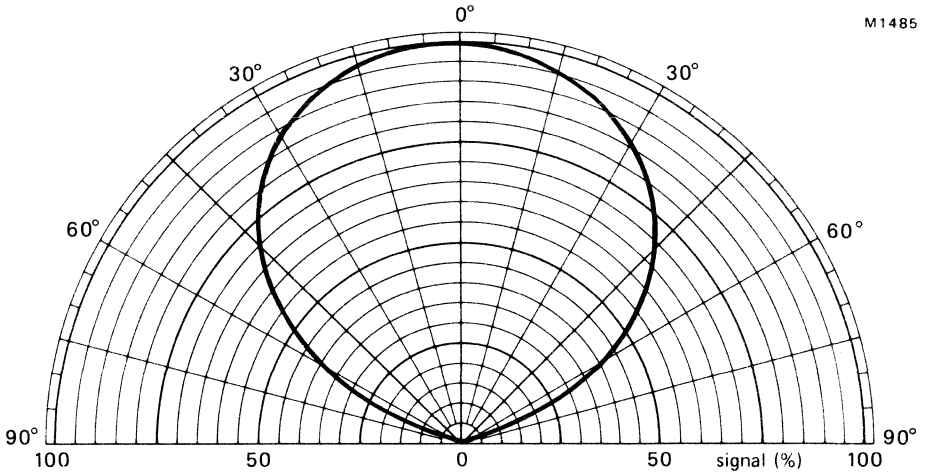

Typical Field of View in x-x plane (see Mechanical Data)

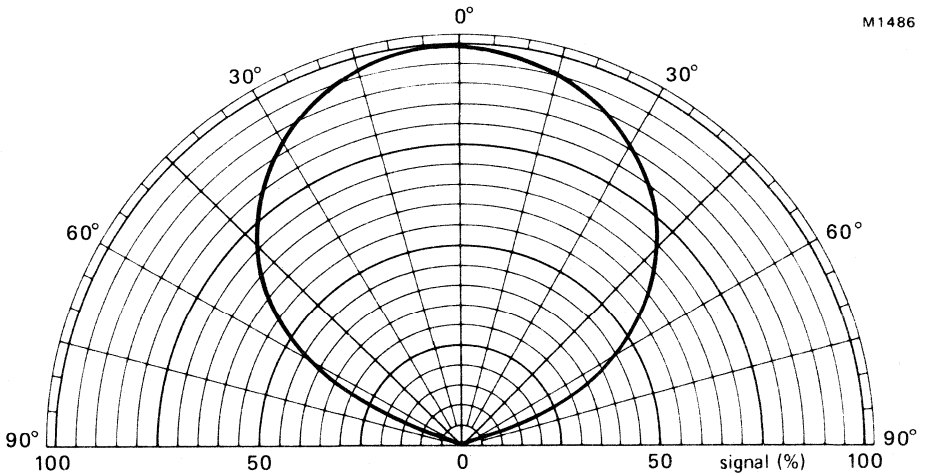

Typical Field of View in y-y plane (see Mechanical Data)

DUAL ELEMENT PYROELECTRIC INFRARED DETECTOR

This is an infrared sensitive device specifically intended for battery operated passive infrared movement sensors, such as intruder alarms. It has differentially connected dual elements specially designed to give improved noise and transient spike performance at elevated temperatures. The wide separation of the elements makes this detector compatible with most optical systems. The dual elements are combined with a single impedance converting amplifier which is designed to operate from low voltage supplies with low current consumption. The detector will give an output signal only when the radiation falling on the elements is unbalanced, as in a focused system. It is sealed in a low profile TO-5 can with a window optically coated to restrict the response to wavelengths greater than 6.5 μm .

QUICK REFERENCE DATA

Spectral Response		6.5 ± 0.5 to >14	μm
Responsivity (10 μm , 10), each element	typ.	150	VW^{-1}
Noise Equivalent Power (N.E.P.) (10 μm , 10, 1), each element	typ.	2.2×10^{-9}	$\text{WHz}^{-1/2}$
Peak signal (500 K, 1)	typ.	460	μV
Noise, peak-to-peak (bandwidth 0.5 Hz to 5 Hz)	typ.	15	μV
Element dimensions, each element	nom.	2×1	mm
Element separation	nom.	1	mm
Field of View in horizontal plane (x-x)	typ.	130	degrees
Operating voltage	min.	3	V
Optimum operating frequency range		0.1 to 20	Hz

This data must be read in conjunction with GENERAL SAFETY RECOMMENDATIONS – OPTOELECTRONIC DEVICES

MECHANICAL DATA

SOT-49H (TO-5 variant)

Dimensions in mm

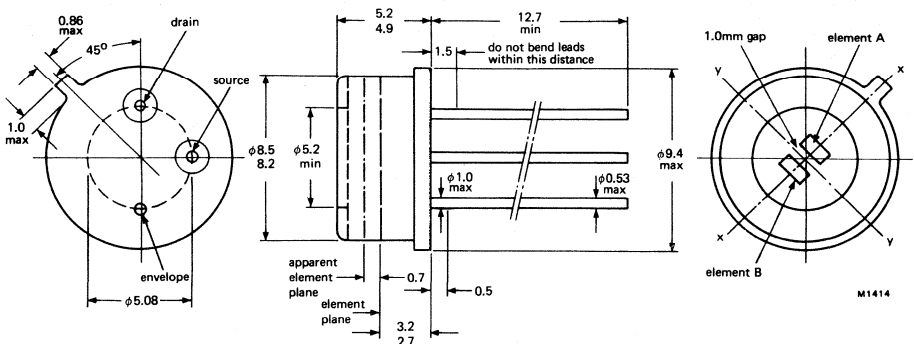

PRODUCT SAFETY

Modern high technology materials have been used in the manufacture of this device to ensure high performance. Some of these materials are toxic in certain circumstances. Mechanical or electrical damage is unlikely to give rise to any hazard, but toxic vapours may be generated if the device is heated to destruction. In the United Kindom disposal of large quantities should therefore be carried out in accordance with the Deposit of Poisonous Waste Act 1972 and the Control of Pollution Act 1974, or with the latest legislation.

SOLDERING

1. When making soldered connections to the leads, a thermal shunt should be used.
2. It is essential that any mains operated soldering iron used should be both screened and earthed. Failure to observe these precautions may lead to the introduction of line voltages and possible damage to the device.

RATINGS

Limiting values in accordance with the Absolute Maximum System (IEC134).

Supply voltage	max.	30	V
Temperature, operating range		-20 to +50	°C
Temperature, storage range		-55 to +85	°C
Lead soldering temperature, ≥ 6 mm from header, $t_{sld} \leq 3$ s max.		+350	°C

OPERATING CONDITIONS

	min.	max.	
Voltage (operating note 5)	3	10	V
Frequency (operating note 5)	0.1	20	Hz

OPERATING NOTES

1. The case potential must not be allowed to become positive with respect to the other two terminals.
2. It is inadvisable to operate the detector at mains related frequencies.
3. To avoid the possibility of optical microphony, the detector must be firmly mounted.
4. An increase in temperature of element A will produce a positive going signal at the output. For element B, the corresponding output will be negative going.
5. The detector will operate outside the quoted range but may have a degraded performance.
6. Before testing, due to the high sensitivity of these detectors, care must be taken to ensure that the devices are allowed to become thermally stable.

CHARACTERISTICS (at $T_{amb} = 22\text{ }^{\circ}\text{C} \pm 3\text{ }^{\circ}\text{C}$ and with recommended circuit)

		min.	typ.	max.	
Spectral Response		6.5 ± 0.5	—	> 14	μm
Responsivity* (10 μm , 10)	note 1	95	150	—	VW^{-1}
N.E.P. (10 μm , 10, 1)	note 1	—	2.2×10^{-9}	—	$\text{WHZ}^{-1/2}$
Element matching* (10 μm , 10)	note 2	—	—	± 20	%
Peak signal (500 K, 1)	note 5	—	460	—	μV
Noise*, peak-to-peak (bandwidth 0.5 Hz to 5 Hz)	note 4	—	15	45	μV
Element matching (10 μm , 1)	note 2	—	—	± 20	%
Field of View (x-x plane, total angle)	note 3	100	130	—	degrees
(y-y plane, total angle)	note 3	85	—	—	degrees
Quiescent current		—	10	—	μA
Element dimensions			2×1 nominal		mm
Element separation			1 nominal		mm

*These parameters are 100% tested with statistical sample quality inspection.

FET Characteristics (at $T_{amb} = 22\text{ }^{\circ}\text{C} \pm 3\text{ }^{\circ}\text{C}$)

		min.	typ.	max.	
Gate-Source Cut-off Voltage					
$I_D = 0.1\text{ }\mu\text{A}$, $V_{DS} = 6\text{ V}$	$V_{P(GS)}$	-1.2	—	-0.5	V
Transfer Conductance					
$V_{GS} = 0$, $V_{DS} = 6\text{ V}$, $f = 1\text{ kHz}$	g_{fso}	1.3	—	—	mAV^{-1}

Notes

- Each element. These characteristics apply throughout the spectral response range.
- With both elements irradiated, the matching of the element signals is derived from:—

$$\frac{\Delta S}{\frac{1}{2}(S_A + S_B)} \times 100$$
 where S_A and S_B are the signals of the two elements and ΔS is the signal with both elements irradiated.
- Field of view to 50% of the maximum signal level.
- Using low noise filter with 3 dB bandwidth and roll off at 12 dB per octave. Detectors tested for 1 minute under stable electrical and thermal conditions; see operating note 6.
- At an energy level of $25\text{ }\mu\text{Wcm}^{-2}$ at the detector.

RECOMMENDED CIRCUIT

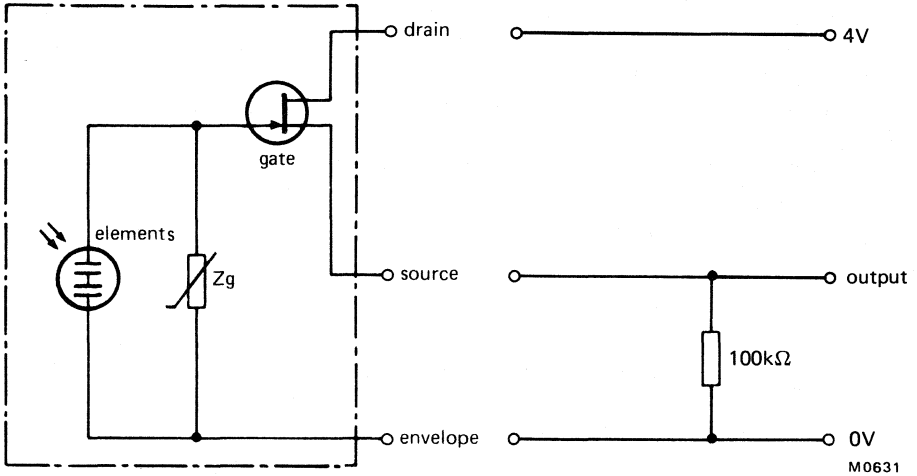

DEFINITIONS

1. Responsivity VW^{-1}
 This is the ratio of the r.m.s. signal in volts to the r.m.s. value of the incident, chopped radiant power. The published values of responsivity are qualified by figures in brackets, for example $(10 \mu m, 10)$. The $10 \mu m$ denotes the wavelength of the infrared radiation generating the signal voltage, while the 10 indicates that the radiation is chopped at a frequency of 10 Hz.
2. Noise Equivalent Power (N.E.P.) $WHz^{-\frac{1}{2}}$
 This is the r.m.s. value of the incident, chopped radiant power necessary to produce an r.m.s. signal to r.m.s. noise ratio of unity. The r.m.s. noise refers to the value calculated for unit square root bandwidth $VHz^{-\frac{1}{2}}$. As with responsivity the relevant test conditions must be specified, for example $(10 \mu m, 10, 1)$. The $10 \mu m$ is the wavelength of the incident radiation, 10 is the chopping frequency in Hz, and 1 is the bandwidth in Hz.

MECHANICAL AND ENVIRONMENTAL STANDARDS

As part of the Quality Assurance programme, the detectors are assessed at regular intervals against the requirements of the following IEC standards. The frequency of testing and the limits and conditions for the pre- and post-test measurements are based on those stipulated for the CECC 50 000 series of approved transistors.

	Test		Severity	Duration	Note
IEC 68-2-3	Ca	Damp Heat, steady state	+40 °C, 95% RH	168 hours	1
68-2-20	Ta	Solderability	+235 °C, 1.5 mm from header	5 seconds	1
68-2-21	Ub	Lead Fatigue	4 cycles	—	1
68-2-1	Aa	Low Temperature Storage	-55 °C	2000 hours	2
68-2-2	Ba	High Temperature Storage	+85 °C	2000 hours	2
68-2-14	Nb	Change of Temperature	-55 °C to +85 °C	10 cycles	2
68-2-6	Fc (B4)	Vibration, swept frequency	125 Hz to 2 kHz 196 ms ⁻²	2 h in each orientation	2
68-2-7	Ga	Acceleration, steady state	196000 ms ⁻²	60 seconds	2
68-2-27	Ea	Shock	14700 ms ⁻²	3 pulses 6 orientations	2
68-2-20	Tb	Resistance to Solder Heat	+350 °C, 6 mm from header	3 seconds	3

Notes

1. The detectors are checked on a production batch release principle at approximately weekly intervals. This is equivalent to Group B.
2. The detectors are checked at quarterly intervals. This is equivalent to Group C.
3. This is an annual check.

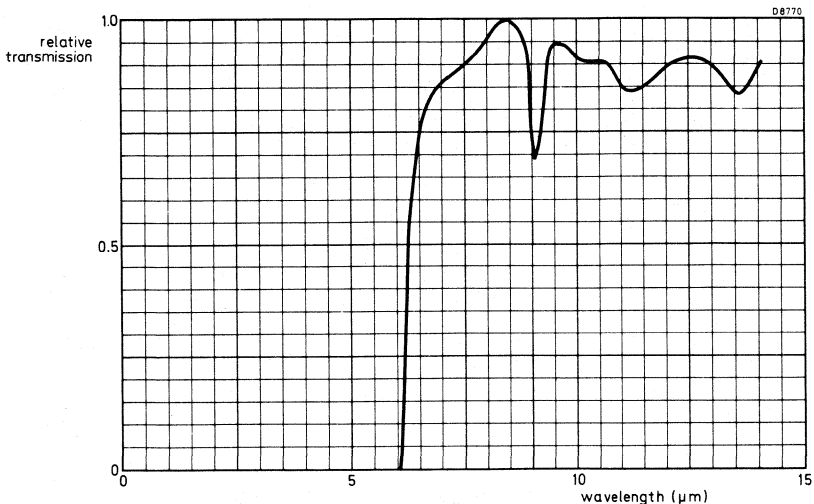

Typical normalized window transmission characteristic

M1421

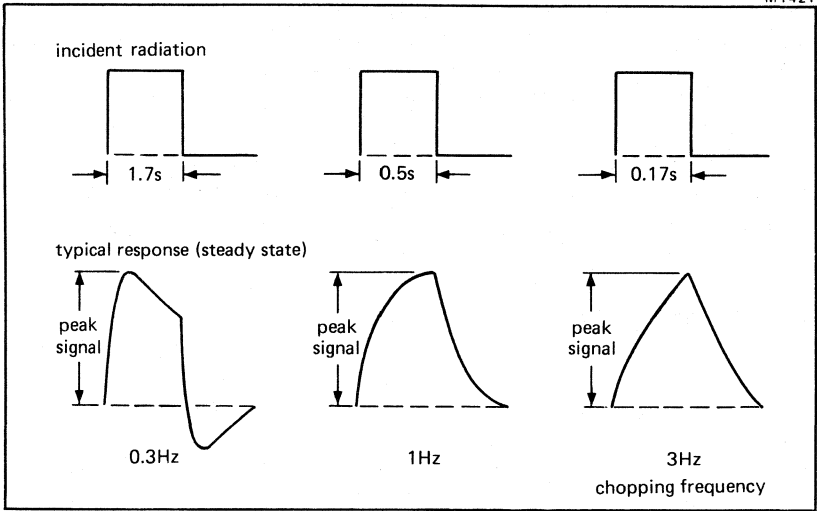

Typical response (steady state) for a given chopping frequency

M1426

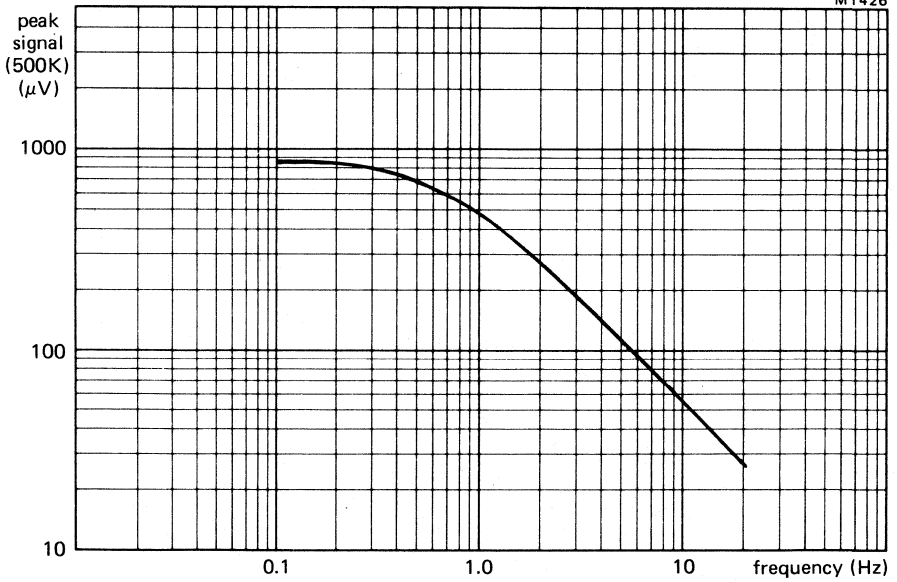

Typical Peak Signal as a function of Frequency
(energy level $25 \mu\text{Wcm}^{-2}$ at the detector and one element screened)

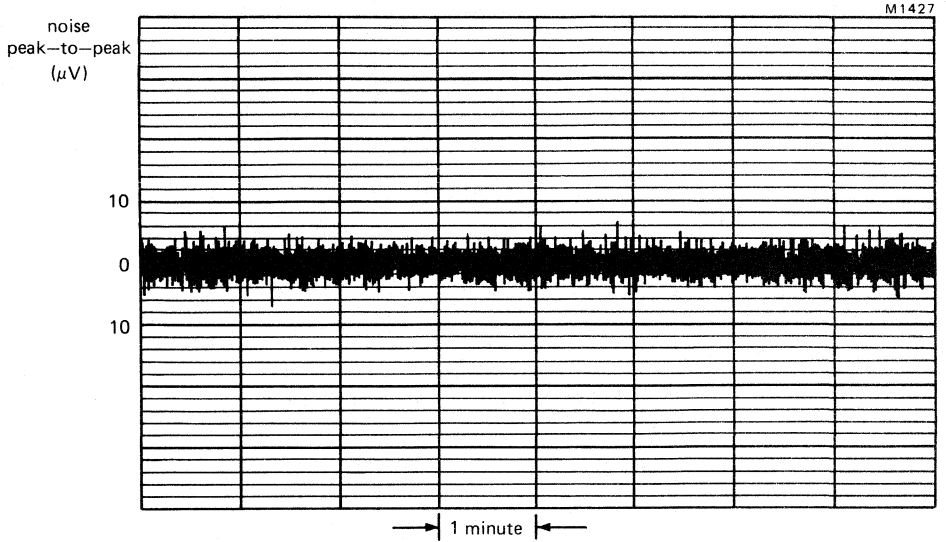

Typical peak-to-peak Noise as a function of Time
(filter bandwidth 0.5 Hz to 5 Hz)

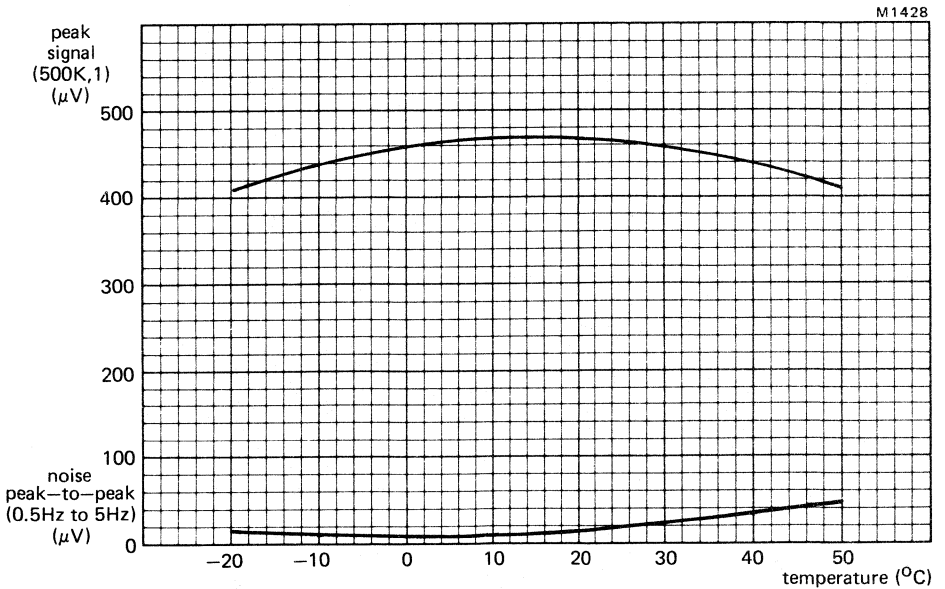

Typical peak Signal and peak-to-peak Noise as functions of Temperature
(peak Signal energy level $25 \mu\text{Wcm}^{-2}$ at the detector, one element screened)

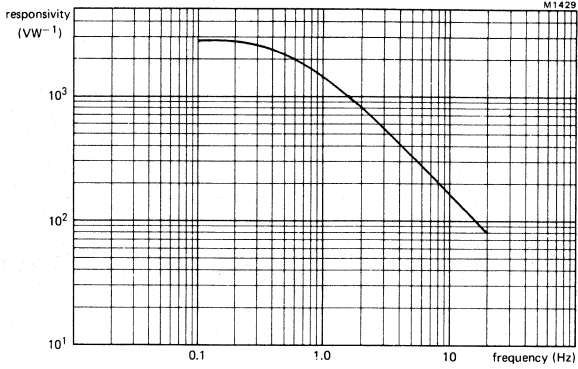

Typical Responsivity as a function of Frequency
(one element screened)

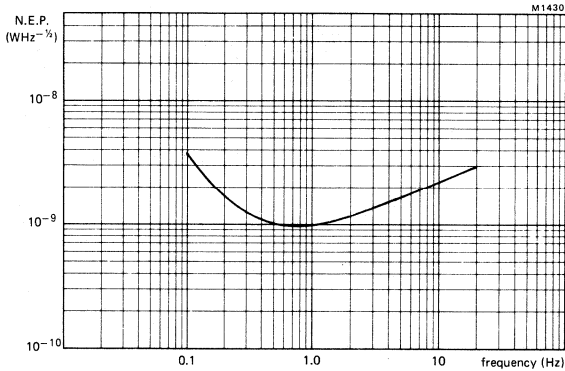

Typical N.E.P. as a function of Frequency
(one element screened)

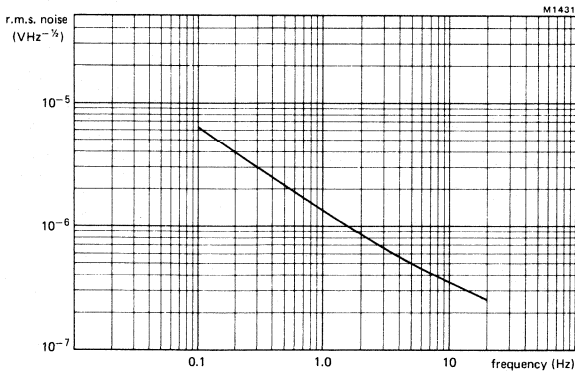

Typical r.m.s. Noise as a function of Frequency
(one element screened)

POLAR DIAGRAMS

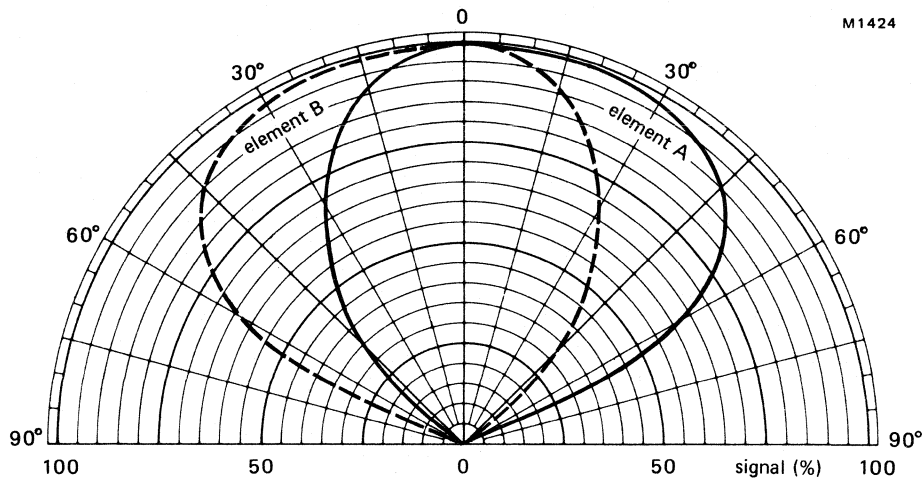

Typical Field of View in x-x plane (see Mechanical Data)

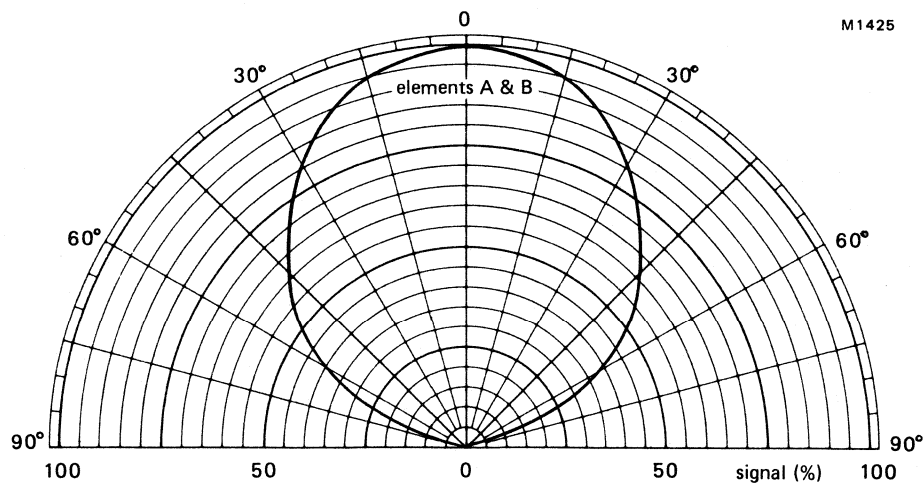

Typical Field of View in y-y plane (see Mechanical Data)

SINGLE ELEMENT PYROELECTRIC INFRARED SENSOR

This is an infrared sensitive device incorporating a single impedance converting amplifier which is specially designed to function from low voltage supplies with low current consumption. The sensor is sealed in a low profile TO-5 can with an uncoated silicon window.

QUICK REFERENCE DATA

Spectral response		1.0 to >15	μm
Responsivity (500 K, 10)	typ.	130	VW^{-1}
Noise Equivalent Power (N.E.P.) (500 K, 10, 1)	typ.	3.0×10^{-9}	$\text{WHz}^{-1/2}$
Peak signal (500 K, 1) see characteristics, note 1	typ.	385	μV
Noise, peak-to-peak (bandwidth 0.4 Hz to 5 Hz)	typ.	20	μV
Element dimensions	nom.	2 x 1	mm
Field of view in horizontal plane (x-x)	typ.	110	degrees
Operating voltage	min.	3	V
Optimum operating frequency range		0.1 to 20	Hz

This data must be read in conjunction with GENERAL SAFETY RECOMMENDATIONS – OPTOELECTRONIC DEVICES

MECHANICAL DATA

SOT-49H (TO-5 variant)

Dimensions in mm

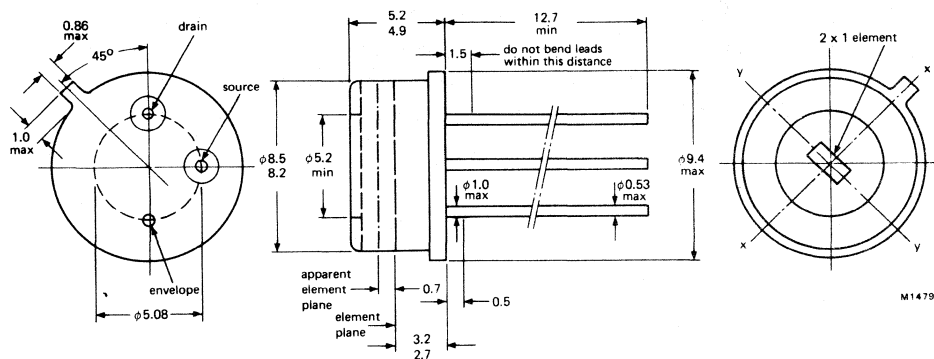

PRODUCT SAFETY

Modern high technology materials have been used in the manufacture of this device to ensure high performance. Some of these materials are toxic in certain circumstances. Mechanical or electrical damage is unlikely to give rise to any hazard, but toxic vapours may be generated if the device is heated to destruction. Disposal of large quantities should therefore be carried out in accordance with the latest local legislation.

SOLDERING

1. When making soldered connections to the leads, a thermal shunt should be used.
2. It is essential that any mains operated soldering iron used should be both screened and earthed. Failure to observe these precautions may lead to the introduction of line voltages and possible damage to the device.

RATINGS

Limiting values in accordance with the Absolute Maximum System (IEC134).

Supply voltage	max.	30	V
Temperature, operating range		-40 to +70	°C
Temperature, storage range		-55 to +85	°C
Lead soldering temperature, ≥ 6 mm from header, $t_{sld} \leq 3$ s		+350	°C

OPERATING CONDITIONS

	min.	max.	
Voltage (operating note 5)	3	10	V
Frequency (operating note 5)	0.1	20	Hz

OPERATING NOTES

1. The case potential must not be allowed to become positive with respect to the other two terminals.
2. It is inadvisable to operate the sensor at mains related frequencies.
3. To avoid the possibility of optical microphony, the sensor must be firmly mounted.
4. An increase in temperature of the element will produce a positive going signal at the output.
5. The sensor will operate outside the quoted range but may have a degraded performance.
6. Before testing, due to the high sensitivity of these sensors, care must be taken to ensure that the devices are allowed to become thermally stable.

CHARACTERISTICS (at $T_{amb} = 22\text{ }^{\circ}\text{C} \pm 3\text{ }^{\circ}\text{C}$ and with recommended circuit)

		min.	typ.	max.	
Spectral response		1.0	—	>15	μm
Responsivity* (500 K, 10)		90	130	—	VW^{-1}
N.E.P. (500 K, 10, 1)		—	3.0×10^{-9}	—	WHz^{-1}
Peak signal (500 K, 1)	note 1	—	385	—	μV
Noise*, peak-to-peak (bandwidth 0.4 Hz to 5 Hz)	note 2	—	20	45	μV
Field of view (x-x plane, total angle)	note 3	90	110	—	degrees
(y-y plane, total angle)	note 3	90	110	—	degrees
Quiescent current		—	10	—	μA
Element dimensions			2 x 1 nominal		mm

*These parameters are 100% tested with statistical sample quality inspection.

FET characteristics (at $T_{amb} = 22\text{ }^{\circ}\text{C} \pm 3\text{ }^{\circ}\text{C}$)

		min.	typ.	max.	
Gate-source cut-off voltage $I_D = 0.1\text{ }\mu\text{A}$, $V_{DS} = 6\text{ V}$	$V_{P(GS)}$	-1.2	—	-0.5	V
Transfer conductance $V_{GS} = 0$, $V_{DS} = 6\text{ V}$, $f = 1\text{ kHz}$	g_{fso}	1.3	—	—	mAV^{-1}

Notes

1. At any energy level of $25\text{ }\mu\text{Wcm}^{-2}$ at the sensor.
2. Using low noise filter with 3 dB bandwidth (0.4 to 5 Hz) and roll off at 12 dB per octave. Sensors tested for 1 minute under stable electrical and thermal conditions; see operating note 6.
3. Field of view to 50% of the maximum signal level.

RECOMMENDED CIRCUIT

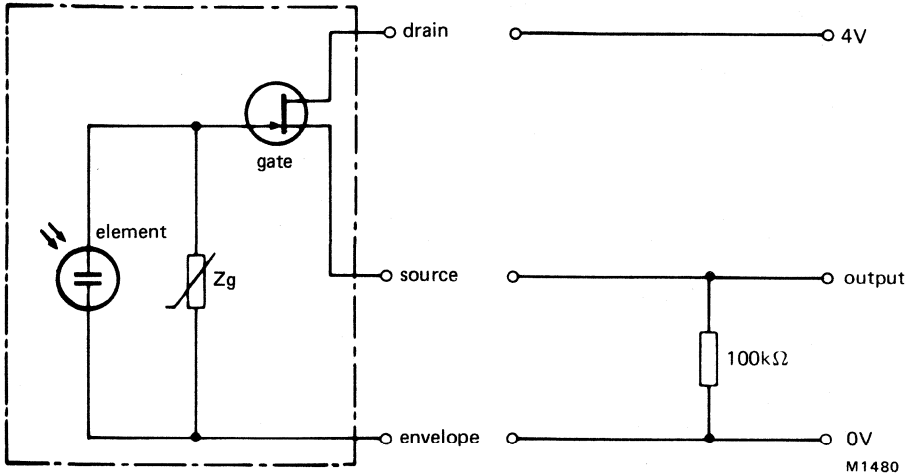

DEFINITIONS

1. **Responsivity VW^{-1}**
 This is the ratio of the r.m.s. signal in volts to the r.m.s. value of the incident, chopped radiant power. The published values of responsivity are qualified by figures in brackets, for example (500 K, 10). The 500 K denotes the temperature of the black body source of the infrared radiation generating the signal voltage, while the 10 indicates that the radiation is chopped at a frequency of 10 Hz.
2. **Noise Equivalent Power (N.E.P.) $WHz^{-1/2}$**
 This is the r.m.s. value of the incident, chopped radiant power necessary to produce an r.m.s. signal to r.m.s. noise ratio of unity. The r.m.s. noise refers to the value calculated for unit square root bandwidth $VHz^{-1/2}$. As with responsivity the relevant test conditions must be specified, for example (500 K, 10, 1). The 500 K is the temperature of the black body source of the incident radiation, 10 is the chopping frequency in Hz, and 1 is the bandwidth in Hz.

MECHANICAL AND ENVIRONMENTAL STANDARDS

As part of the Quality Assurance programme, the sensors will be assessed at regular intervals against the requirements of the following IEC standards. The frequency of testing and the limits and conditions for the pre- and post-test measurements are based on those stipulated for the CECC 50 000 series of approved transistors.

	Test		Severity	Duration	Note
IEC 68-2-3	Ca	Damp Heat, steady state	+40 °C, 95% RH	168 hours	1
68-2-20	Ta	Solderability	+235 °C, 1.5 mm from header	5 seconds	1
68-2-21	Ub	Lead Fatigue	4 cycles	—	1
68-2-1	Aa	Low Temperature Storage	-55 °C	2000 hours	2
68-2-2	Ba	High Temperature Storage	+85 °C	2000 hours	2
68-2-14	Nb	Change of Temperature	-55 °C to +85 °C	10 cycles	2
68-2-6	Fc (B4)	Vibration, swept frequency	125 Hz to 2 kHz 196 ms ⁻²	2 h in each orientation	2
68-2-7	Ga	Acceleration, steady state	196000 ms ⁻²	60 seconds	2
68-2-27	Ea	Shock	14700 ms ⁻²	3 pulses 6 orientations	2
68-2-20	Tb	Resistance to Solder Heat	+350 °C, 6 mm from header	3 seconds	3

Notes

1. The sensors to be checked on a production batch release principle at approximately weekly intervals. This is equivalent to Group B.
2. The sensors to be checked at quarterly intervals. This is equivalent to Group C.
3. This is an annual check.

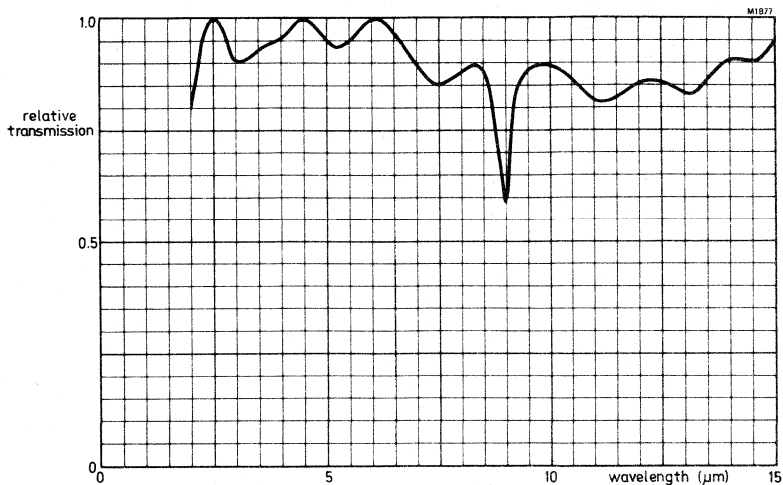

Typical normalized window transmission characteristic

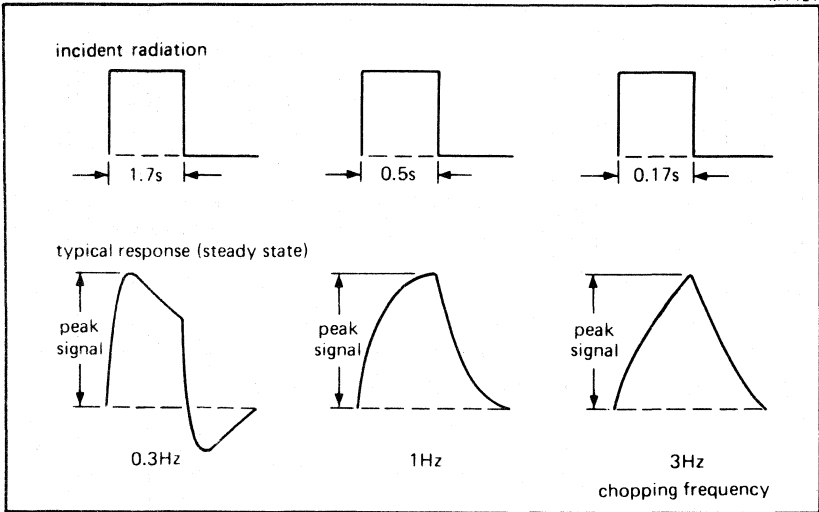

Typical response (steady state) for a given chopping frequency

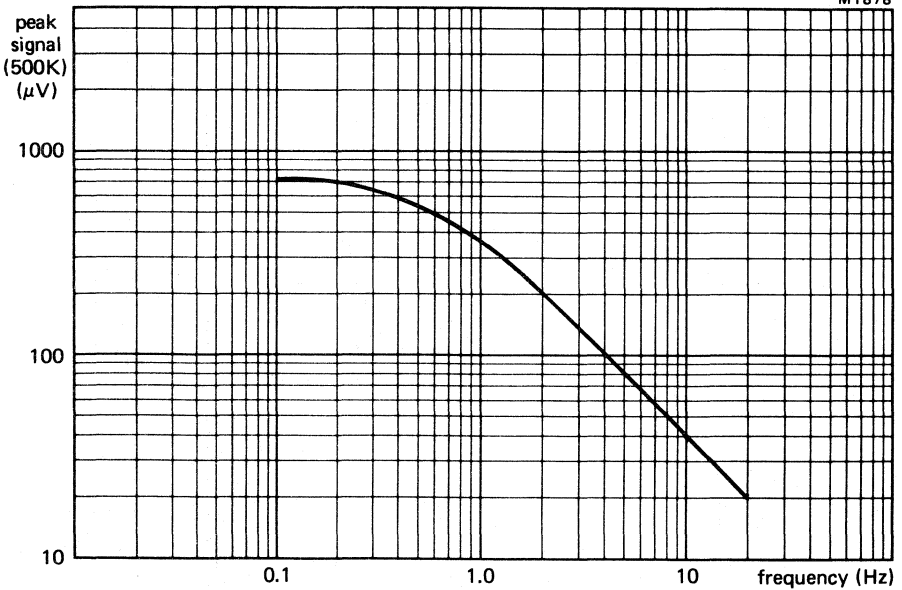

Typical peak signal as a function of frequency
(energy level $25 \mu\text{Wcm}^{-2}$ at the sensor)

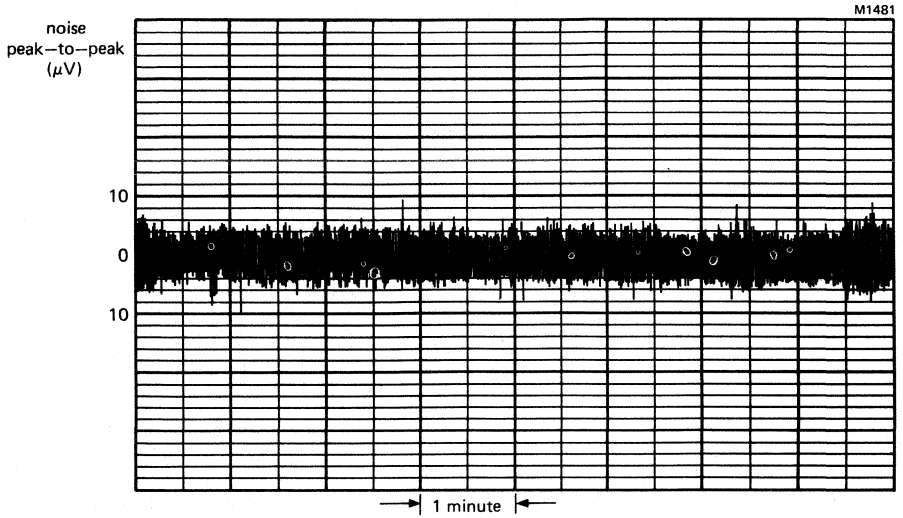

Typical peak-to-peak noise as a function of time
(filter bandwidth 0.5 Hz to 5 Hz)

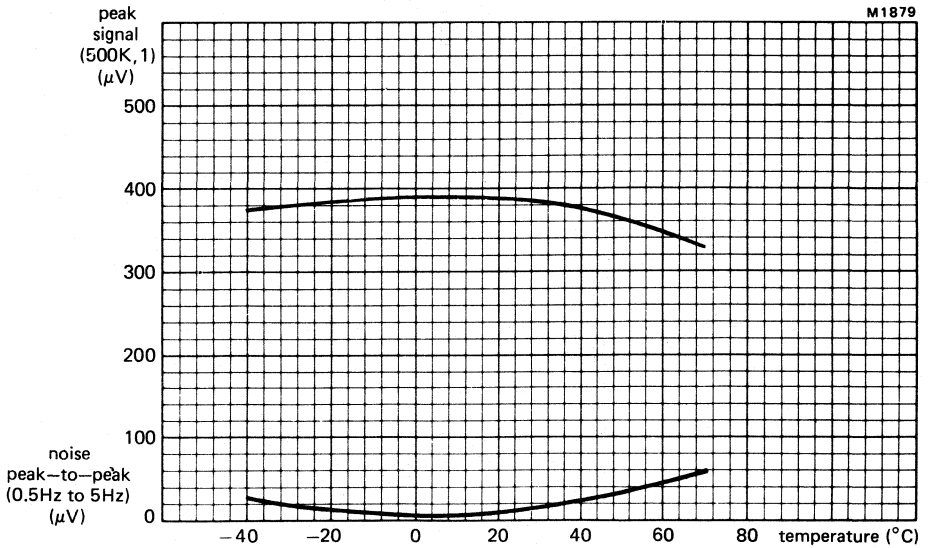

Typical peak signal and peak-to-peak noise
as functions of temperature
(peak signal energy level, $25 \mu\text{Wcm}^{-2}$ at the sensor)

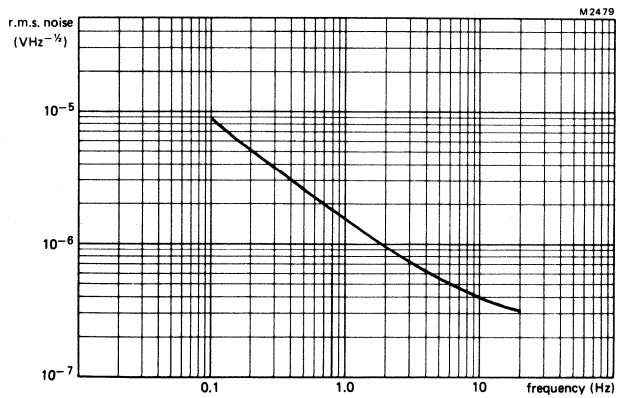
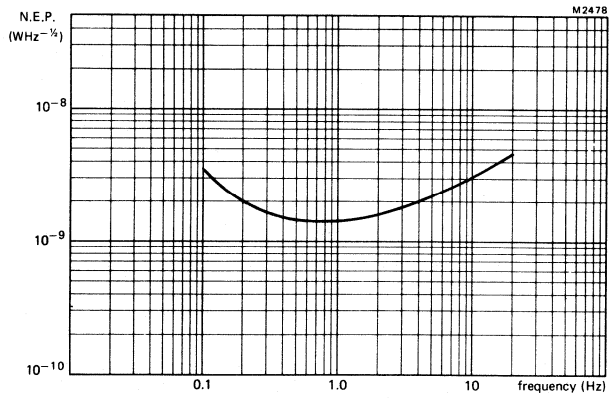
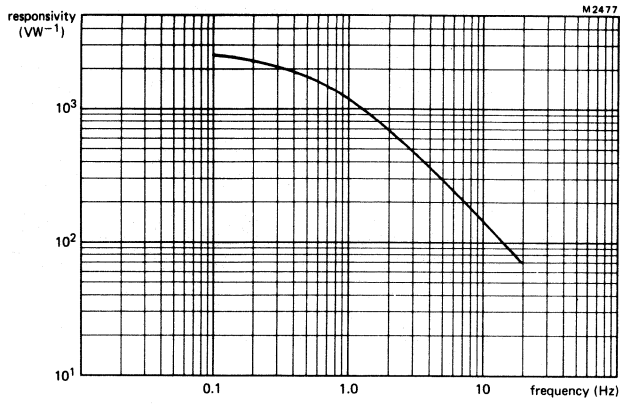

Typical responsivity, N.E.P., and r.m.s. noise as functions of frequency using recommended circuit.

POLAR DIAGRAMS

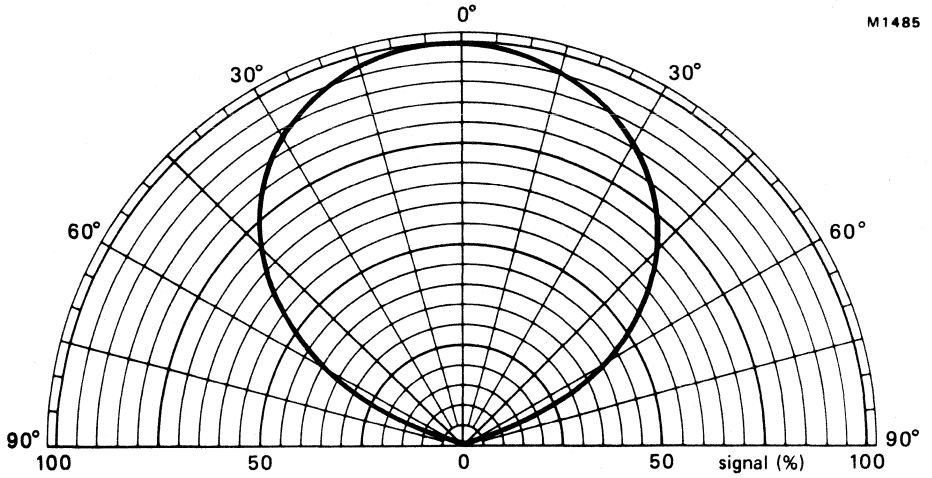

Typical field of view in x-x plane (see Mechanical data)

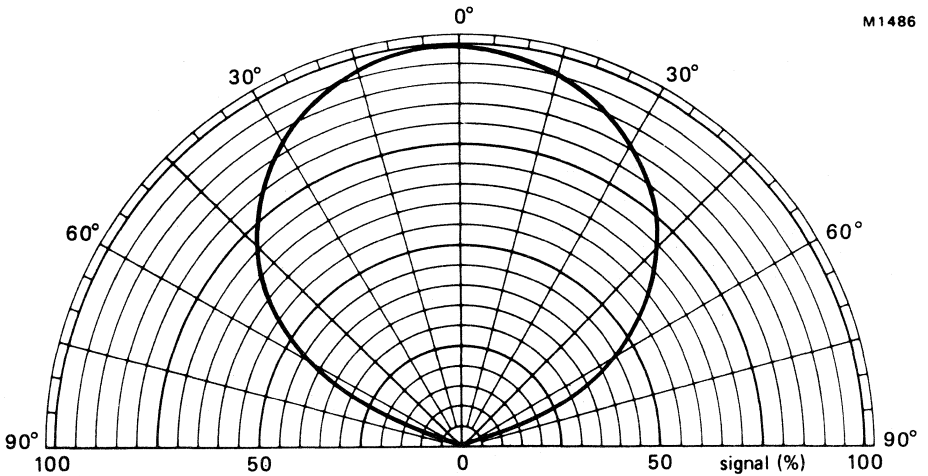

Typical field of view in y-y plane (see Mechanical Data)

DEVELOPMENT DATA

This data sheet contains advance information and specifications are subject to change without notice.

RPY109

SINGLE ELEMENT PYROELECTRIC INFRARED DETECTOR

This is an infrared sensitive device incorporating a single impedance converting amplifier which is specially designed to function from low voltage supplies with low current consumption. The detector is sealed in a low profile TO-5 can with an uncoated silicon window.

QUICK REFERENCE DATA

Spectral response		1.0 to >15	μm
Responsivity (500 K, 10)	typ.	65	VW^{-1}
Noise Equivalent Power (N.E.P.) (500 K, 10, 1)	typ.	6.0×10^{-9}	$\text{WHz}^{-1/2}$
Peak signal (500 K, 1) see characteristics, note 1	typ.	385	μV
Noise, peak-to-peak (bandwidth 0.5 Hz to 5 Hz)	typ.	15	μV
Element dimensions	nom.	2 x 2	mm
Field of view in horizontal plane (x-x)	typ.	110	degrees
Operating voltage	min.	3	V
Optimum operating frequency range		0.1 to 20	Hz

This data must be read in conjunction with GENERAL SAFETY RECOMMENDATIONS – OPTOELECTRONIC DEVICES

MECHANICAL DATA

Dimensions in mm

SOT-49H (TO-5 variant)

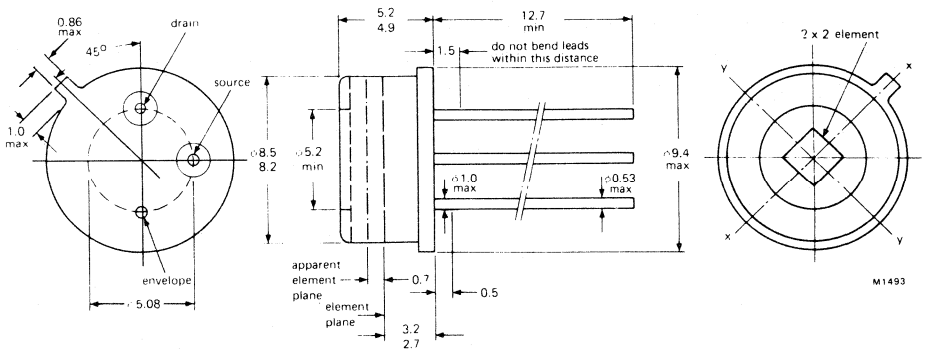

PRODUCT SAFETY

Modern high technology materials have been used in the manufacture of this device to ensure high performance. Some of these materials are toxic in certain circumstances. Mechanical or electrical damage is unlikely to give rise to any hazard, but toxic vapours may be generated if the device is heated to destruction. In the United Kingdom disposal of large quantities should therefore be carried out in accordance with the Deposit of Poisonous Waste Act 1972 and the Control of Pollution Act 1974, or with the latest legislation.

SOLDERING

1. When making soldered connections to the leads, a thermal shunt should be used.
2. It is essential that any mains operated soldering iron used should be both screened and earthed. Failure to observe these precautions may lead to the introduction of line voltages and possible damage to the device.

RATINGS

Limiting values in accordance with the Absolute Maximum System (IEC134).

Supply voltage	max.	30	V
Temperature, operating range		-40 to +70	°C
Temperature, storage range		-55 to +85	°C
Lead soldering temperature, ≥ 6 mm from header, $t_{sld} \leq 3$ s max.		+350	°C

OPERATING CONDITIONS

	min.	max.	
Voltage (operating note 5)	3	10	V
Frequency (operating note 5)	0.1	20	Hz

OPERATING NOTES

1. The case potential must not be allowed to become positive with respect to the other two terminals.
2. It is inadvisable to operate the detector at mains related frequencies.
3. To avoid the possibility of optical microphony, the detector must be firmly mounted.
4. An increase in temperature of the element will produce a positive going signal at the output.
5. The detector will operate outside the quoted range but may have a degraded performance.
6. Before testing, due to the high sensitivity of these detectors, care must be taken to ensure that the devices are allowed to become thermally stable.

CHARACTERISTICS (at $T_{amb} = 22 \text{ }^\circ\text{C} \pm 3 \text{ }^\circ\text{C}$ and with recommended circuit)

		min.	typ.	max.	
Spectral Response		1.0	—	>15	μm
Responsivity* (500 K, 10)		45	65	—	VW^{-1}
N.E.P. (500 K, 10, 1)		—	6.0×10^{-9}	—	WHz^{-1}
Peak signal (500 K, 1)	note 1	—	385	—	μV
Noise*, peak-to-peak (bandwidth 0.5 Hz to 5 Hz)	note 2	—	15	45	μV
Field of View (x-x plane, total angle)	note 3	90	110	—	degrees
(y-y plane, total angle)	note 3	90	110	—	degrees
Quiescent current		—	10	—	μA
Element dimensions			2 x 2 nominal		mm

*These parameters are 100% tested with statistical sample quality inspection.

FET Characteristics (at $T_{amb} = 22 \text{ }^\circ\text{C} \pm 3 \text{ }^\circ\text{C}$)

		min.	typ.	max.	
Gate-Source Cut-off Voltage $I_D = 0.1 \mu\text{A}$, $V_{DS} = 6 \text{ V}$	$V_{P(GS)}$	-1.2	—	-0.5	V
	Transfer Conductance $V_{GS} = 0$, $V_{DS} = 6 \text{ V}$, $f = 1 \text{ kHz}$	g_{fso}	1.3	—	—

Notes

1. At an energy level of $25 \mu\text{Wcm}^{-2}$ at the detector.
2. Using low noise filter with 3 dB bandwidth and roll off at 12 dB per octave. Detectors tested for 1 minute under stable electrical and thermal conditions; see operating note 6.
3. Field of view to 50% of the maximum signal level.

DEVELOPMENT DATA

RECOMMENDED CIRCUIT

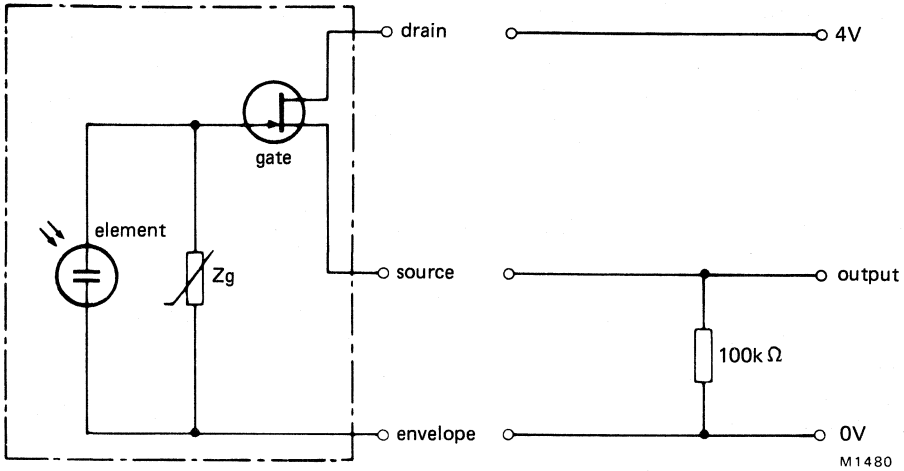

M1480

DEFINITIONS

1. Responsivity VW^{-1}

This is the ratio of the r.m.s. signal in volts to the r.m.s. value of the incident, chopped radiant power. The published values of responsivity are qualified by figures in brackets, for example (500 K, 10). The 500 K denotes the temperature of the black body source of the infrared radiation generating the signal voltage, while the 10 indicates that the radiation is chopped at a frequency of 10 Hz.

2. Noise Equivalent Power (N.E.P.) $WHz^{-1/2}$

This is the r.m.s. value of the incident, chopped radiant power necessary to produce an r.m.s. signal to r.m.s. noise ratio of unity. The r.m.s. noise refers to the value calculated for unit square root bandwidth $VHz^{-1/2}$. As with responsivity the relevant test conditions must be specified, for example (500 K, 10, 1). The 500 K is the temperature of the black body source of the incident radiation, 10 is the chopping frequency in Hz, and 1 is the bandwidth in Hz.

MECHANICAL AND ENVIRONMENTAL STANDARDS

As part of the Quality Assurance programme, the detectors will be assessed at regular intervals against the requirements of the following IEC standards. The frequency of testing and the limits and conditions for the pre- and post-test measurements are based on those stipulated for the CECC 50 000 series of approved transistors.

	Test		Severity	Duration	Note
IEC 68-2-3	Ca	Damp Heat, steady state	+40 °C, 95% RH	168 hours	1
68-2-20	Ta	Solderability	+235 °C, 1.5 mm from header	5 seconds	1
68-2-21	Ub	Lead Fatigue	4 cycles	—	1
68-2-1	Aa	Low Temperature Storage	-55 °C	2000 hours	2
68-2-2	Ba	High Temperature Storage	+85 °C	2000 hours	2
68-2-14	Nb	Change of Temperature	-55 °C to +85 °C	10 cycles	2
68-2-6	Fc (B4)	Vibration, swept frequency	125 Hz to 2 kHz 196 ms ⁻²	2 h in each orientation	2
68-2-7	Ga	Acceleration, steady state	196000 ms ⁻²	60 seconds	2
68-2-27	Ea	Shock	14700 ms ⁻²	3 pulses 6 orientations	2
68-2-20	Tb	Resistance to Solder Heat	+350 °C, 6 mm from header	3 seconds	3

DEVELOPMENT DATA

Notes

1. The detectors to be checked on a production batch release principle at approximately weekly intervals. This is equivalent to Group B.
2. The detectors to be checked at quarterly intervals. This is equivalent to Group C.
3. This is an annual check.

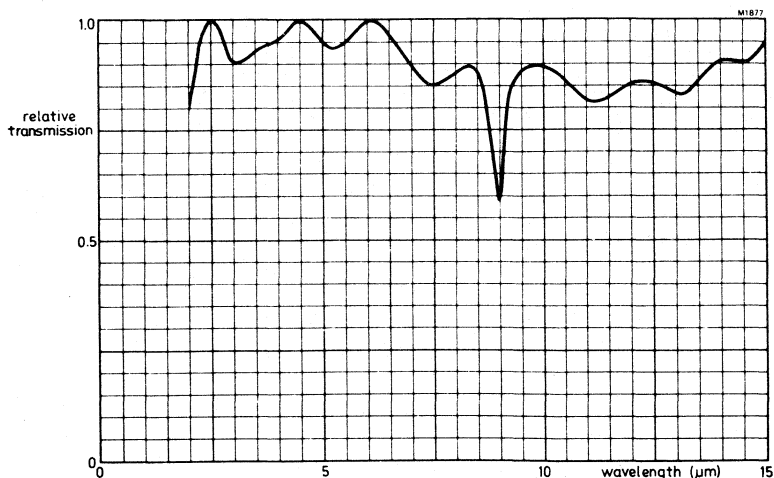

Typical normalized window transmission characteristic

M1421

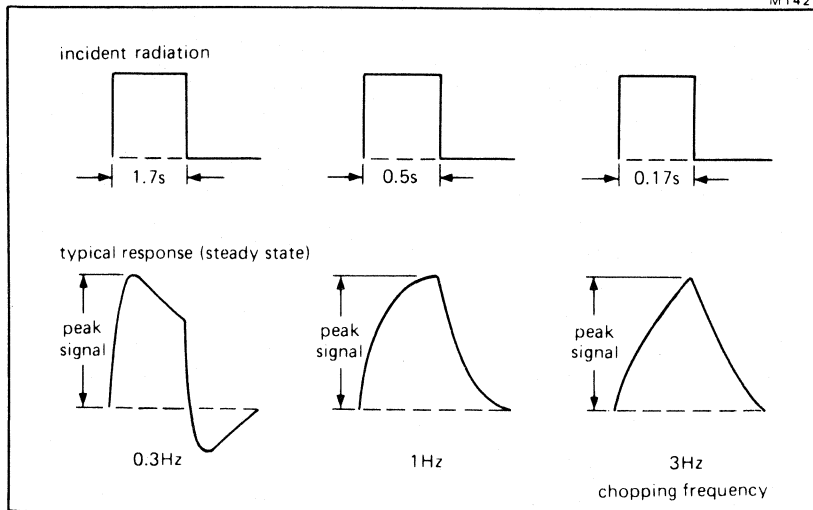

Typical response (steady state) for a given chopping frequency

M1878

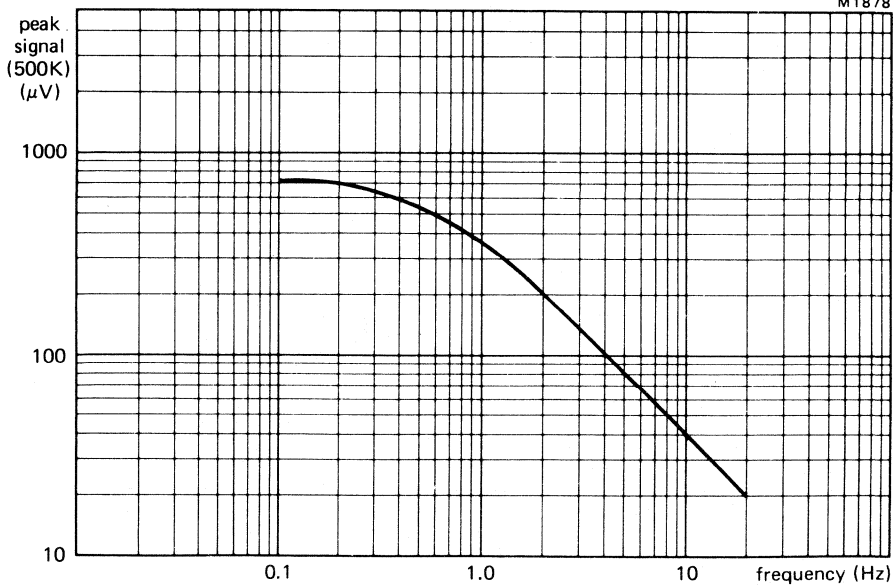

Typical peak Signal as a function of Frequency
(energy level $25 \mu W cm^{-2}$ at the detector)

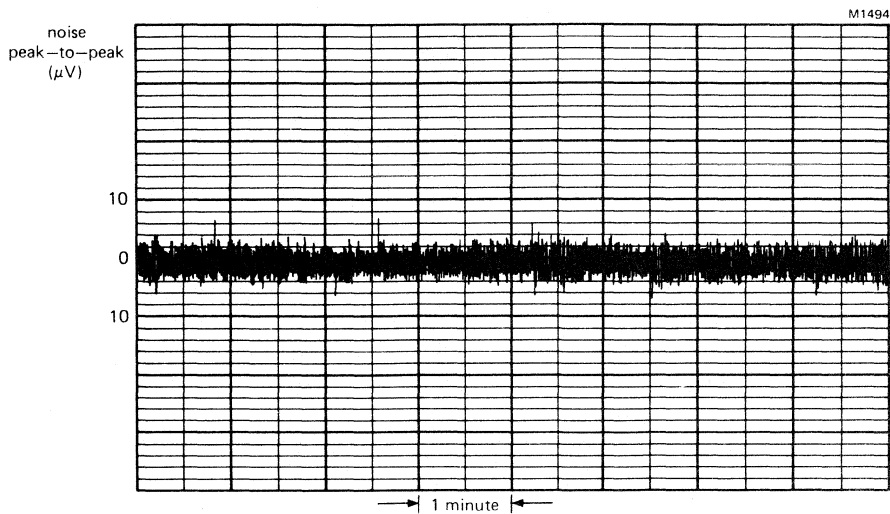

Typical peak-to-peak Noise as a function of Time
(filter bandwidth 0.5 Hz to 5 Hz)

DEVELOPMENT DATA

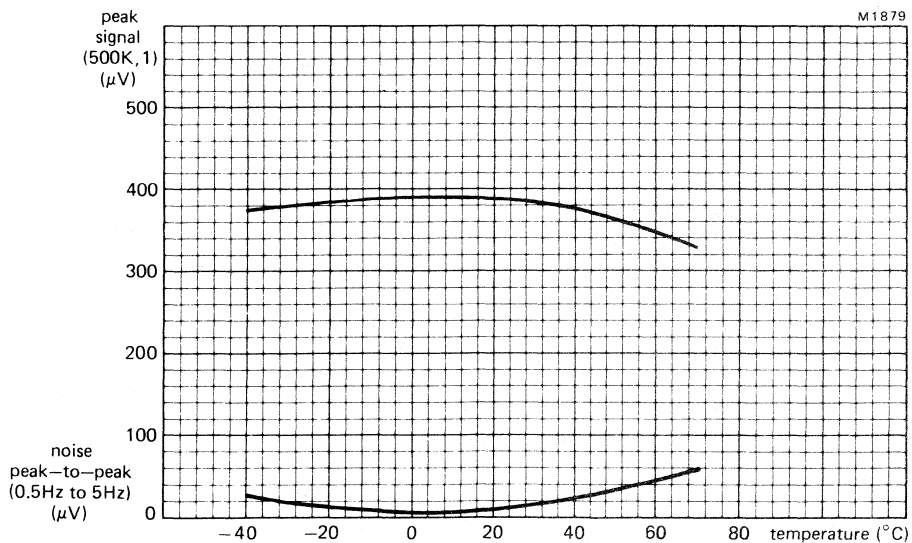

Typical peak Signal and peak-to-peak Noise
as functions of Temperature
(peak Signal energy level, $25 \mu\text{Wcm}^{-2}$ at the detector)

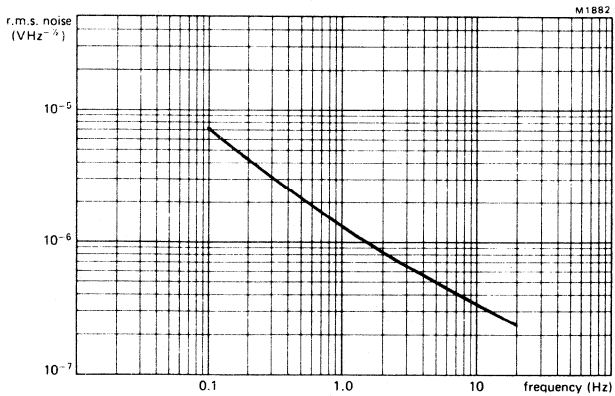
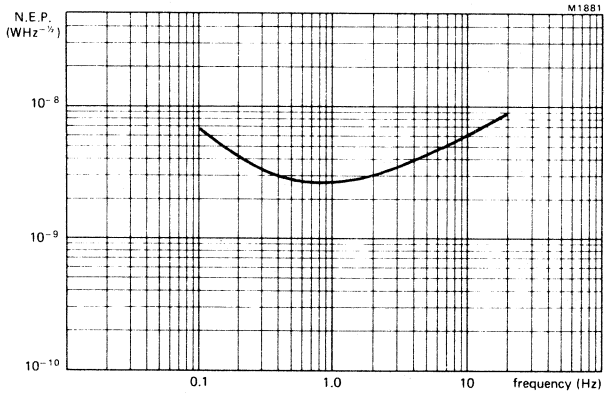
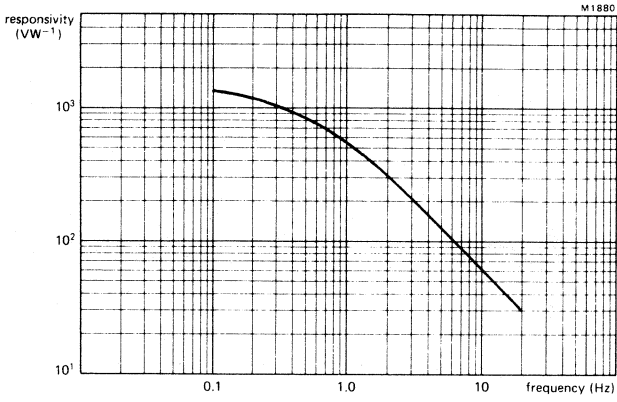

Typical Responsivity, N.E.P., and r.m.s. Noise as functions of Frequency, using recommended circuit.

POLAR DIAGRAMS

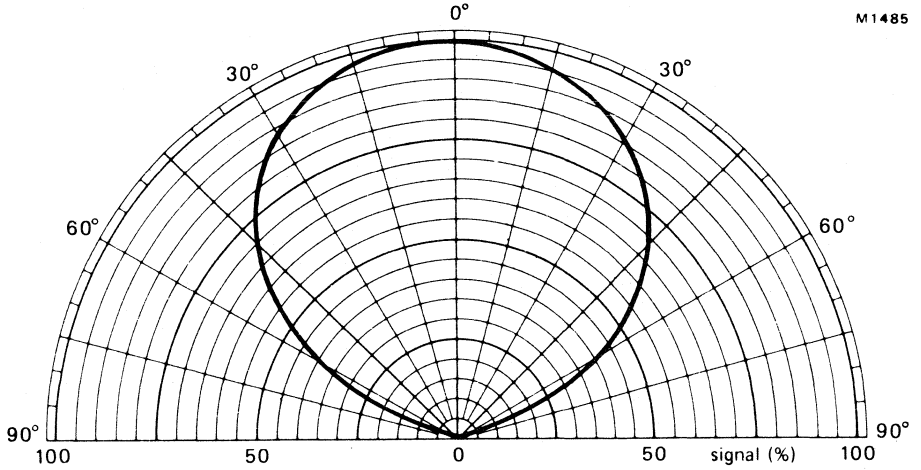

M1485

Typical Field of View in x-x plane (see Mechanical Data)

DEVELOPMENT DATA

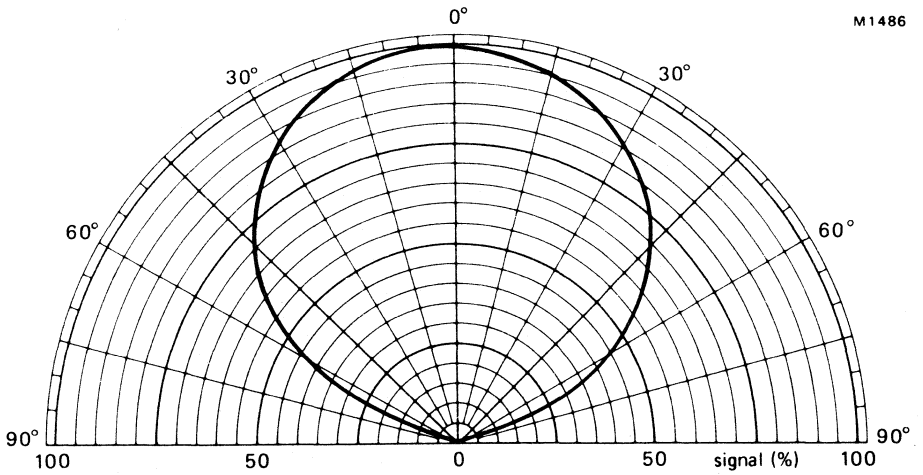

M1486

Typical Field of View in y-y plane (see Mechanical Data)

DEVELOPMENT DATA

This data sheet contains advance information and specifications are subject to change without notice.

P2105
(DEV. NO)

SINGLE ELEMENT PYROELECTRIC INFRARED DETECTOR

This is an infrared sensitive device intended for gas analysis systems such as that used for analysing car exhausts. The element is combined with a single impedance converting amplifier which is specially designed to operate from low voltage supplies with low current consumption. The detector is sealed in a 3-lead TO-5 encapsulation modified to incorporate a potassium bromide (KBr) window.

QUICK REFERENCE DATA

Spectral Response		1 to 25	μm
Responsivity (500 K, 10)	typ.	90	VW^{-1}
Noise Equivalent Power (N.E.P.) (500 K, 10, 1)	typ.	1.4×10^{-9}	$\text{WHz}^{-1/2}$
D^* (500 K, 10, 1)	typ.	1.4×10^8	$\text{cmHz}^{1/2}\text{W}^{-1}$
Element dimensions	nom.	2 x 2	mm
Field of view in horizontal plane (x-x)	min.	60	degrees
Operating voltage	min.	3	V
Optimum operating frequency range		10 to 100	Hz

This data must be read in conjunction with GENERAL SAFETY RECOMMENDATIONS – OPTOELECTRONIC DEVICES

MECHANICAL DATA

Dimensions in mm

SOT-49G (TO-5 variant)

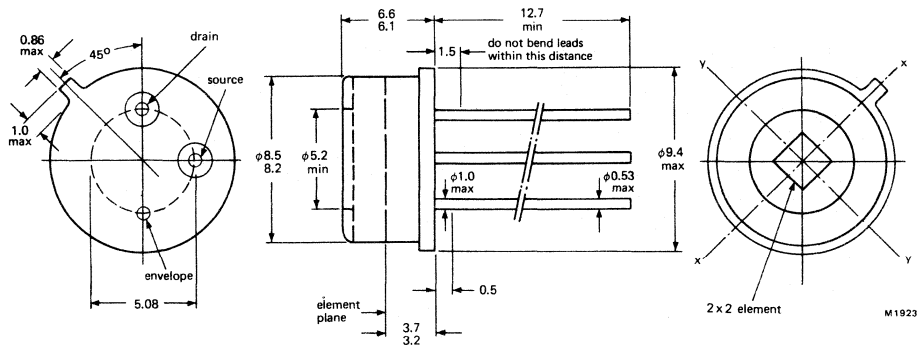

PRODUCT SAFETY

Modern high technology materials have been used in the manufacture of this device to ensure high performance. Some of these materials are toxic in certain circumstances. Mechanical or electrical damage is unlikely to give rise to any hazard, but toxic vapours may be generated if the device is heated to destruction. Disposal of large quantities should therefore be carried out in accordance with the latest local legislation.

SOLDERING

1. When making soldered connections to the leads, a thermal shunt should be used.
2. It is essential that any mains operated soldering iron used should be both screened and earthed. Failure to observe these precautions may lead to the introduction of line voltages and possible damage to the device.

RATINGS

Limiting values in accordance with the Absolute Maximum System (IEC134).

Supply voltage	max.	30	V
Temperature, operating range		-20 to +70	°C
Temperature, storage range		-20 to +70	°C
Lead soldering temperature, ≥ 6 mm from header, $t_{sld} \leq 3$ s max.		+350	°C

OPERATING CONDITIONS

	min.	max.	
Voltage (operating note 5)	3	10	V
Frequency (operating note 5)	10	100	Hz

OPERATING NOTES

1. The case potential must not be allowed to become positive with respect to the other two terminals.
2. It is inadvisable to operate the detector at mains related frequencies.
3. To avoid the possibility of optical microphony, the detector must be firmly mounted.
4. An increase in temperature of the element will produce a positive going signal at the output.
5. The detector will operate outside the quoted range but may have a degraded performance.
6. Before testing, due to the high sensitivity of these detectors, care must be taken to ensure that the devices are allowed to become thermally stable.

CHARACTERISTICS (at $T_{amb} = 22\text{ }^{\circ}\text{C} \pm 3\text{ }^{\circ}\text{C}$ and with recommended circuit)

		min.	typ.	max.	
Spectral Response		1.0	—	25	μm
Responsivity (500 K, 10)		60	90	—	VW^{-1}
N.E.P. (500 K, 10, 1)		—	1.4×10^{-9}	3×10^{-9}	WHz^{-1}
D^* (500 K, 10, 1)		—	1.4×10^8	—	$\text{cmHz}^{1/2}\text{W}^{-1}$
Field of View (x-x plane, total angle)	note 1	60	—	—	degrees
(y-y plane, total angle)	note 1	60	—	—	degrees
Quiescent current		—	10	—	μA
Element dimensions			2 x 2 nominal		mm

FET Characteristics (at $T_{amb} = 22\text{ }^{\circ}\text{C} \pm 3\text{ }^{\circ}\text{C}$)

		min.	typ.	max.	
Gate-Source Cut-off Voltage					
$I_D = 0.1\text{ }\mu\text{A}$, $V_{DS} = 6\text{ V}$	$V_{P(GS)}$	-1.2	—	-0.5	V
Transfer Conductance					
$V_{GS} = 0$, $V_{DS} = 6\text{ V}$, $f = 1\text{ kHz}$	g_{fso}	1.3	—	—	mAV^{-1}

Notes

1. Field of view to 50% of the maximum signal level.

DEVELOPMENT DATA

RECOMMENDED CIRCUIT

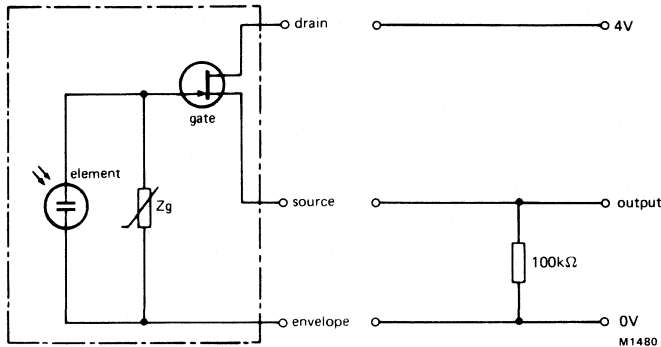

DEFINITIONS

1. Responsivity VW^{-1}

This is the ratio of the r.m.s. signal in volts to the r.m.s. value of the incident, chopped radiant power. The published values of responsivity are qualified by figures in brackets, for example (500 K, 10). The 500 K denotes the temperature of the black body source of the infrared radiation generating the signal voltage, while the 10 indicates that the radiation is chopped at a frequency of 10 Hz.

2. Noise Equivalent Power (N.E.P.) $WHz^{-1/2}$

This is the r.m.s. value of the incident, chopped radiant power necessary to produce an r.m.s. signal to r.m.s. noise ratio of unity. The r.m.s. noise refers to the value calculated for unit square root bandwidth $VHz^{-1/2}$. As with responsivity the relevant test conditions must be specified, for example (500 K, 10, 1). The 500 K is the temperature of the black body source of the incident radiation, 10 is the chopping frequency in Hz, and 1 is the bandwidth in Hz.

3. $D^* \text{ cmHz}^{1/2}W^{-1}$

This is a figure of merit for the material used in the detector and takes account of element size and signal to noise ratio. It is used to specify and compare detectors and in contrast to N.E.P., has a higher value for a better performance device.

D^* is defined by the expression:
$$D^* = \frac{V_s}{V_n} \frac{[A (\Delta f)]^{1/2}}{W}$$

- where V_s = Signal voltage across detector terminals
- V_n = Noise voltage across detector terminals
- A = Detector area
- (Δf) = Bandwidth of measuring amplifier
- W = Radiated power incident on detector (r.m.s. value in watts)

The Noise Equivalent Power (N.E.P.) is related to D^* by the expression:

$$N.E.P. = \frac{(A)^{1/2}}{D^*}$$

MECHANICAL AND ENVIRONMENTAL STANDARDS

As part of the Quality Assurance programme, the detectors will be assessed at regular intervals against the requirements of the following IEC standards. The limits and conditions for the pre- and post-test measurements are based on those stipulated for the CECC 50 000 series of approved transistors.

	Test		Severity	Duration
IEC 68-2-3	Ca	Damp Heat, steady state	+20 °C, 70% RH	96 hours
68-2-20	Ta	Solderability	+235 °C, 1.5 mm from header	5 seconds
68-2-21	Ub	Lead Fatigue	4 cycles	—
68-2-1	Aa	Low Temperature Storage	-20 °C	2000 hours
68-2-2	Ba	High Temperature Storage	+70 °C	2000 hours
68-2-14	Nb	Change of Temperature	-20 °C to +70 °C	10 cycles
68-2-6	Fc (B4)	Vibration, swept frequency	125 Hz to 2 kHz 196 ms ⁻²	2 h in each orientation
68-2-7	Ga	Acceleration, steady state	196000 ms ⁻²	60 seconds
68-2-27	Ea	Shock	14700 ms ⁻²	3 pulses 6 orientations
68-2-20	Tb	Resistance to Solder Heat	+350 °C, 6 mm from header	3 seconds

DEVELOPMENT DATA

MOVEMENT SENSING USING A MULTI-ELEMENT FRESNEL LENS

1. INTRODUCTION

Our pyroelectric sensors are used extensively in passive infrared movement sensing applications where high sensitivity, reliability and low cost are basic requirements.

Although these sensors may be used directly to monitor scene thermal changes, it is generally advantageous to employ collecting optics to focus radiation on to the device. Thin, highly transmitting Fresnel lenses can collect infrared radiation very efficiently and provide optical gain over a defined field of view. This publication reviews the basic properties of Fresnel lenses in terms of geometric optics and describes the use of our Fresnel lens, which has been developed for general purpose movement sensing applications.

2. THE PROPERTIES OF FRESNEL LENSES

2.1 The Fresnel Lens

In applications such as movement sensing, it is often necessary to employ short focal length, large aperture lenses, to collect sufficient radiation from what may be a weak or distant source. Unfortunately, the unavoidable thickness of such lenses rules out standard lens materials because of absorption losses. On the other hand, materials which have very low absorption, over the 6 to 14 μm wavelength range, are generally too expensive for commercial use.

Fresnel lenses, however, offer a neat solution to such problems since they can be produced in extremely thin sheets and thus allow the use of materials which have relatively poor transmission (e.g. polyethylene). They are essentially equivalent to thick conventional lenses, but with most of the bulk material between the outer surfaces removed. Without elaborating further, the equivalence of both types of lenses can be shown by considering the laws of refraction. This shows that the ray bending or refracting power of a lens is a function of surface curvature (and material refractive index) rather than the path length within the body of the lens.

In modern Fresnel lens designs, the profile of each groove facet is determined by computer simulation to produce the sharpest possible image from a distant object.

Although it is possible to produce Fresnel lenses of very large area, the effects of total internal reflection dictate that it is not useful to have a lens diameter much greater than the focal length. Radiation reaching areas beyond this is merely reflected back into the lens.

2.2 Lens operation and formulae

This section reviews the properties of lenses in terms of geometrical optics. This idealized approach gives sufficiently accurate results for most practical situations.

2.2.1. Focusing and imaging formulae

A lens is a device having refracting power and can be used to collect parallel rays (radiation) and focus them at a single point. The greater the refracting power of a lens, the closer the focal point will be to the lens. Focal length is defined as the distance between the focal point and lens centre and is a basic measure of the radiation gathering ability of a lens.

The focal length of a thin, plano-convex lens is given by:

$$\frac{1}{f} = (n-1) \frac{1}{r}$$

Where n represents the lens refractive index (approx. 1.5 for polyethylene) and r is the lens radius of curvature at its centre.

FRESNEL LENS

Object and image positions are related by the standard formula.

$$\frac{1}{f} = \frac{1}{\ell'} - \frac{1}{\ell}$$

Where ℓ and ℓ' are object and image distances respectively. Details regarding sign convention for this formula can be found in Reference 1.

An implication of this formula is that all rays pass through the lens centre undeviated. This can be seen by considering rays from a small object h , placed on one side of the lens, as shown in Figure 1, where ℓ is greater than f .

For clarity only two extreme and one central ray are shown per object point. These are just particular rays in what is in fact a ray cone or bundle.

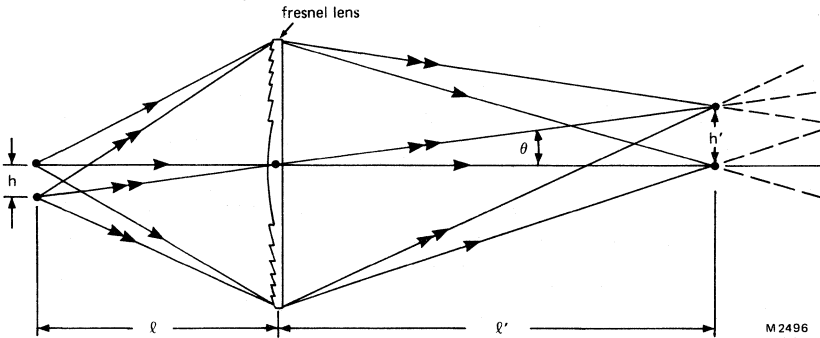

Figure 1 Image and object positions

A simple relationship exists between object and image size. By similar triangles, the magnification (M) is given directly as:

$$M = \frac{h'}{h} = \frac{\ell'}{\ell}$$

Where h and h' are object and image heights respectively.

Manipulation of the standard formula yields two further useful expressions for magnification:

$$M = 1 - \frac{\ell'}{f} \quad \text{and} \quad M = \frac{1}{\frac{\ell}{f} + 1}$$

The effect of positioning an object about the focal point is shown in Figure 2.

When the object is precisely at the focal point P_1 , the rays refracted by the lens emerge parallel to each other. Shifting the object away from the lens to P_2 causes the emergent rays to converge to a point P_2' . A shift towards the lens creates a divergent ray bundle.

Since the path of light rays is reversible, the points P_2 and P_2' are interchangeable. A radiating source (object) at P_2' will be imaged at P_2 the usual position for a sensing element. Moreover, radiation from a source positioned on the right hand side of the lens will be directed on to P_2 (the sensor), provided they are of the appropriate direction and within the

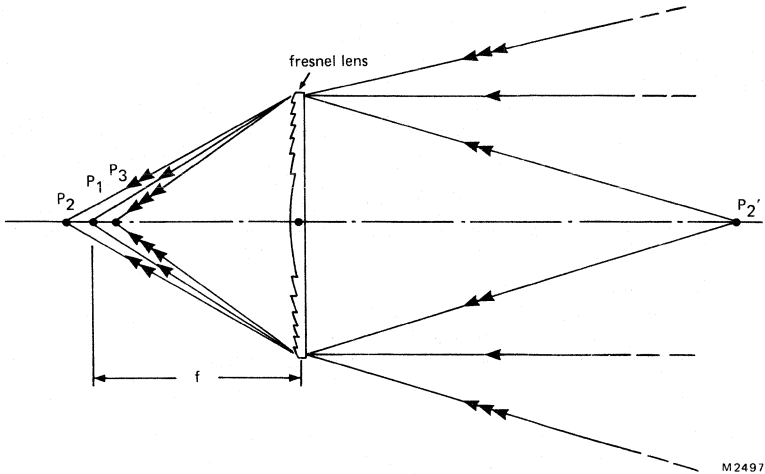

Figure 2 Effect of object shift

M2497

system 'field of view' (see section 2.2.2). In all cases, the line joining the centres of the lens and the sensor defines the direction (sensing) axis.

Returning to Figure 1, it can be seen that the ray cones overlap least at the image points. Thus the images of two adjacent sensor elements placed at P_2 (Figure 2), will be sharply defined and separated only near P_2' .

2.2.2 Field of view

An optical instrument such as a telescope may be used to view a limited area of a distant scene. This area limit, or object field of view, applies equally well to a lens and sensor system. A small object, placed near the focal point of a lens as in Figure 1, has an angular field of view (θ) given approximately as:

$$\theta = \frac{h}{f}$$

(NOTE: This angle is not to be confused with the sensor field of view).

2.2.3 Lens radiation collection

Although focal length determines the refracting power of a lens, the amount of radiation collected is also dependent on the effective collecting area.

A lens imaging a very distant source has a radiation gathering ability given by:

$$\text{Radiation collection} = \frac{K}{\text{f-number}^2}$$

Where f-number is the ratio of focal length over lens diameter and K is a constant.

An effective collecting area is implied in this expression. In general, it is simply the area within the rim of the lens; however, a lens inclined at an angle α to the direction axis has its effective area and collection reduced by a factor $\cos(90-\alpha)$.

Collection is further reduced because of decreased transmission and image degradation (aberrations) of a tilted lens; the latter causes radiation to be redirected outside the defined image area.

3. MULTI-ELEMENT FRESNEL LENSES (ARRAYS)

Fresnel lens arrays are becoming increasingly favoured as radiation collecting devices for use with pyroelectric sensors.

The discrete field of view monitored by each element, coupled with a moving source, modulates the radiation incident on the sensor and thus causes pyroelectric signal generation. Significant signals occur whenever a thermal source passes from an unmonitored to monitored area, or vice versa.

By distributing many elements over the area of the array, extended coverage can be achieved.

Fresnel lens arrays have many advantages over equivalent reflecting optics arrays. Briefly these are:

- Less bulky and lighter
- Can be used without external windows
- Do not require specialized coating
- Cheaper to produce both in tooling and quantity unit costs

3.1 Our Fresnel lens array

We have developed a low cost Fresnel lens array for use with our sensors, suitable for general purpose movement sensing applications. It is designed to provide high sensitivity, long range monitoring up to a least 12 metres, with 90° volumetric coverage.

The lens specification is outlined in Table 1 and Figure 3.

Table 1 Lens Specification/Data

Focal length	30.5	mm
Nominal coverage	12 metres x 90	°
Number of monitored zones	A = 8 B = 4 C = 3	
Nominal average transmission	50	%
Material	polyethylene	

MECHANICAL DATA

Nominal dimensions in mm

For mounted lens

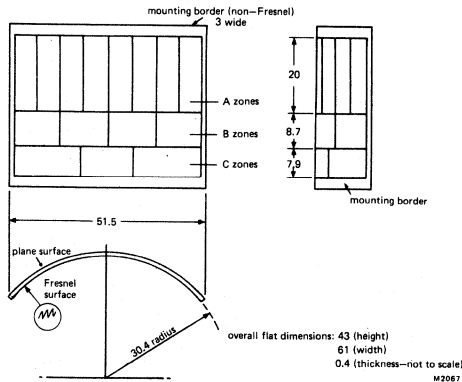

Figure 3 Lens mechanical data

The important features of the lens are:—

- A 15 element design which provides high signal sensitivity and movement discrimination.
- High quality optics match the imaging requirements of dual element sensors. Single element sensors may also be used, with reduced coverage (i.e. 50% fewer zones).
- Fresnel groove depth and thus transmission is constant over whole lens area.
- All elements are designed to give optimum radiation collection at the range limit — aspheric groove contours minimize image aberrations.
- Each element includes part of the central ring which maintains high collection efficiency — less loss due to inter-groove shadowing, scattering and diffraction.
- Can be used grooves-in or grooves-out, depending on requirements. In dusty environments grooves-in is recommended. If this is not the case, or if an external window is used, we recommend that the lens be used grooves-out, thus providing up to 20% more signal than with grooves-in.

3.1.1 Typical usage and performance

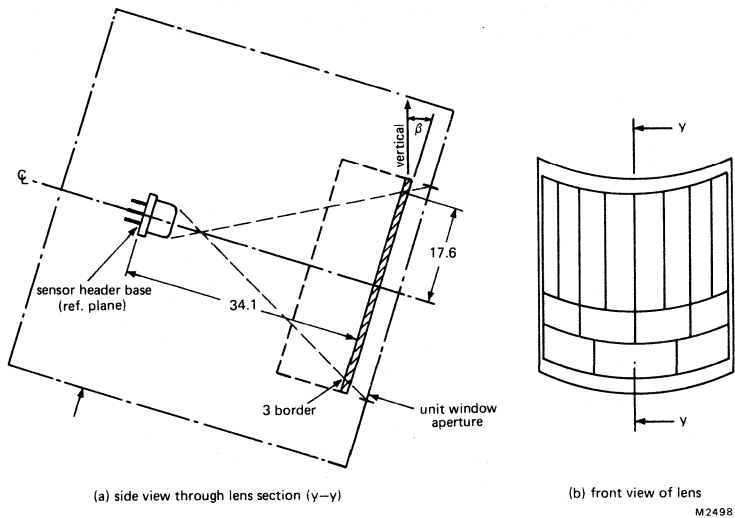

Figure 4 Typical mounting arrangement

A typical lens mounting arrangement is shown in Figures 4a and 4b, which represent the side and front views respectively. In Figure 4a the sensor plane and the lens section (y-y) are parallel and are inclined by an angle β to the vertical.

In this configuration all 'A' and 'B' elements are almost perpendicular to their respective direction axes (element to sensor centres), which ensures optimum collection along the zones. Objects positioned at the range limit are essentially in focus on the sensor. In addition, the system field of view is such that a human outline, at this range, just fills a 2 x 1 mm sensor area.

Nominal zonal coverage, corresponding to $\beta = 12^\circ$ and a fixing height of 2.1 metres, is depicted in Figures 5 and 6.

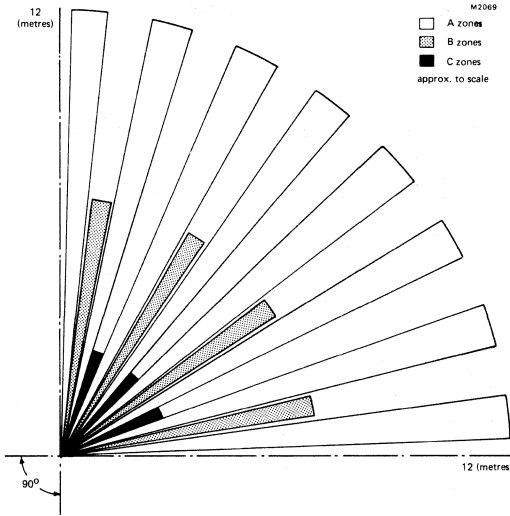

Figure 5 Nominal zonal coverage – plan view

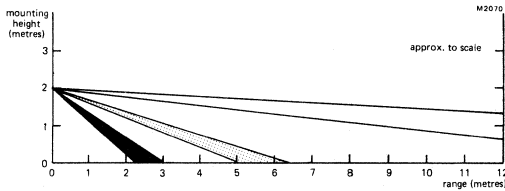

Figure 6 Nominal zonal coverage – side view

The minimum window aperture for the enclosure can be determined with reference to Figure 4a; namely by extending the dotted line from sensor to lens edges (vertically and horizontally) until they intersect the enclosure face.

A typical curve of sensor response against target range, for a single 'A' zone is shown in Figure 7. Because pyroelectric signal generation is proportional to radiant energy differences, this response curve will be strongly dependent on both background and target temperatures. The reduction of signal at short range results from minor cancellation effects. Such effects occur whenever both elements of a dual element sensor receive a proportion of energy from the same source.

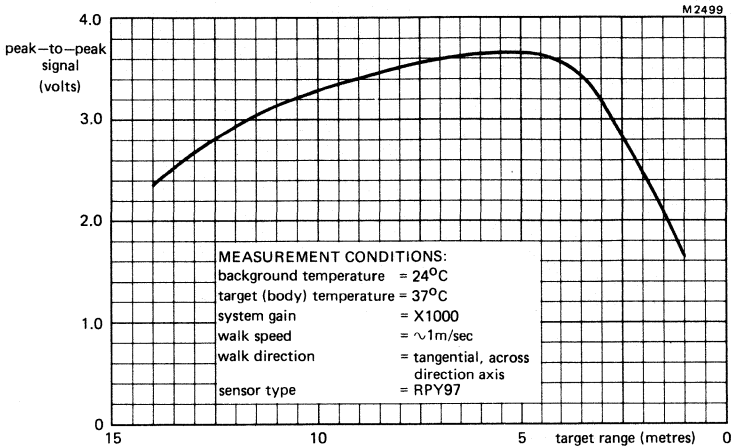

Figure 7 Typical signal level as a function of target range

3.1.2 Alternative mounting configurations

Although the mounting arrangement in Figure 4 will be suitable for most general applications, particular situations may dictate alternative configurations. Useful alternative mounting arrangements fall into two categories, a) where the unit is repositioned as a whole, and b) where the lens is repositioned relative to the sensor. Unit orientation and mounting height fall into the first category, whilst a different lens tilt angle, relative to a fixed sensor position, belongs to the latter category. The effect on system performance associated with any such changes needs careful consideration, particularly with regard to changes in zonal coverage and signal response.

The monitoring of a small room is one example where improved performance will be obtained by changes to the standard mounting arrangement. More effective coverage and increased signal levels will be achieved by inclining the zone-fan downwards or by shifting the whole zone-fan vertically downwards. The former can be achieved by a downward tilt of the unit whilst the latter simply requires a reduction in fixing height. In both cases, moving the lens and sensor as a unit does not affect the position of zones relative to one another.

FRESNEL LENS

The lens may be used equally well in other configurations where constraints such as unit shape restrictions dictate. In cases where it is necessary to change the position/orientation of the lens relative to the sensor, consideration must be given to associated changes in focusing as well as zonal coverage and signal response.

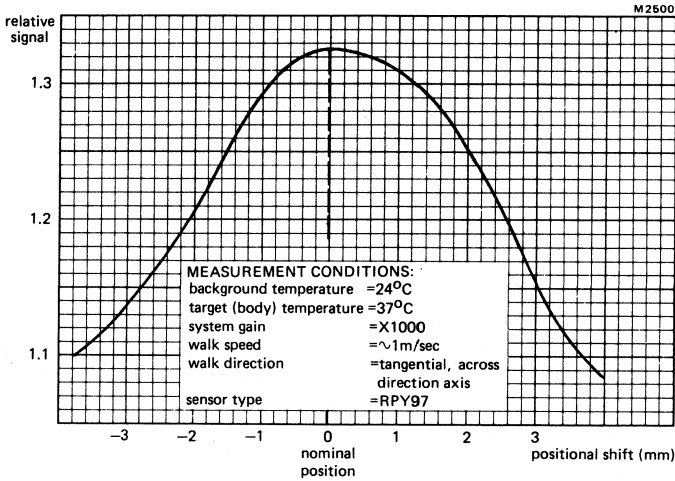

Figure 8 Typical relative signal as a function of sensor position

For guidance, a plot of signal sensitivity versus sensor position, for a single 'A' zone, is given in Figure 8, where the peak of the curve corresponds to the sensor in its nominal position. At this point, the image of the object at the design range is sharply defined so as to ensure minimum signal cancellation, after image motion across the elements.

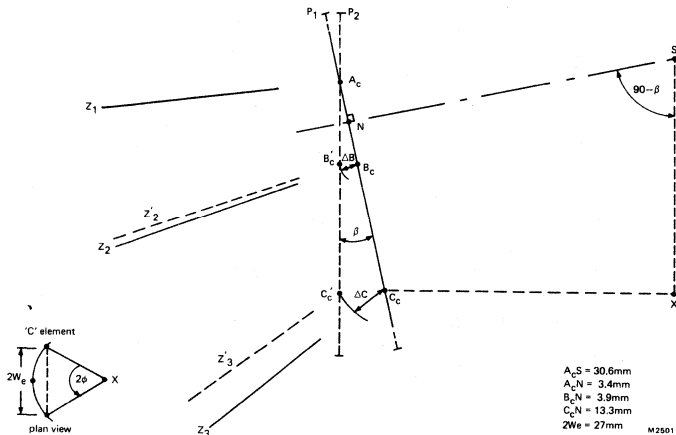

Figure 9 Zonal coverage as a function of lens tilt

The effect of lens tilt angle on zonal coverage is illustrated in Figure 9, where lens position P_1 corresponds to a 12° tilt for nominal zonal coverage. Only the central vertical section of the lens is shown. A_C is an 'A' zone element centre, and is taken as being the section. B_C and C_C are the corresponding points for the B and C elements and S is the sensor position. S, A_C, B_C and C_C define the direction axes Z_1, Z_2 and Z_3 for position P_1 . Note that the outer elements also define direction axes in space but have been omitted for clarity.

Another lens position of particular interest is that with the lens vertical (zero tilt) which corresponds to P_2 in the diagram. To maintain the nominal 'A' zone direction, the lens has been vertically rotated about A_C . This rotation also ensures that 'A' zone focusing is unaffected. Although direction axis Z_1 is common to position P_2 the new directions for the 'B' and 'C' zones become Z'_2 and Z'_3 . Thus the zone-fan is compressed vertically, and the greatest shift occurs along the C element direction. Even so, the 'aiming' points of the 'B' and 'C' zone axes are shifted by only approx. 400 mm, along the floor. Such small shifts can be compensated for by repositioning the sensor along $A_C S$, at the penalty of 'A' zone defocusing.

For all tilt angles other than 0° , the inclination of the extreme zones differs slightly from the central ones of any row. Over a lens tilt range of 0 to 14° (fixed sensor position), however, the effect is of little practical significance. At 12° tilt, for instance the extreme 'A' zone aims at a point approx. 500 mm above the central 'A' zone, at 12 metres range. Because of the shorter distances involved, the effect is also insignificant for the 'B' and 'C' zones.

The projected angle of any zone fan onto the horizontal plane is also affected by lens tilt. For tilt angles below 14° the effect is small, and may be neglected for the 'A' and 'B' zones, given fixed S and rotation as in the diagram. For the 'C' zones, the sine of the projected zone fan semi-angle ϕ changes from:

$$\sin \phi \approx \frac{W_e}{C_C X} \approx \frac{W_e}{C'_C X - A_C C_C \sin \beta} \text{ to}$$

$$\sin \phi \approx \frac{W_e}{C'_C X} \text{ after rotation,}$$

where $C'_C X = A_C N \sin \beta + SN \cos \beta$ and W_e is the half-distance between the outer 'C' zone elements (see plan view inset). With the geometry of the lens given, simple trigonometry can be used to calculate the changes in fan angle. The total projected 'C' zone fan-angle is approximately 60° for a 14° tilt and changes to 52° at zero tilt.

Although the element to sensor distance $A_C S$ is taken to be fixed after rotation, lens geometry is such that the focusing distance of all 'A' zone elements, (to S) also remains essentially constant. This is not the case for the 'B' and 'C' element focusing distances, which are increased by ΔB and ΔC , respectively. For both these rows of elements, images which are sharply focused at S, now correspond to object points much closer to the lens. As a consequence of defocusing, increased cancellation effects reduce signal levels for the 'B' and 'C' zones at maximum range (see Figure 7); because of the proximity of object sources, the effect is less significant for the 'B' zones.

Because of the factors outlined in section 2.2.3, signal reduction also occurs as a direct result of lens inclination to the direction axis. For the 'A' zones, lens inclination to Z_1 is similar for both 0° and 12° tilt, so that radiation collection is unchanged. The 'B' and 'C' direction axes, however, are increasingly inclined to the lens after rotation to P_1 . Typical signal reduction factors versus lens inclination angle α can be estimated from the curve in Figure 10. In this case, the additional signal reduction for the 'B' and 'C' zones after rotation, is approximately 50% and 60% respectively.

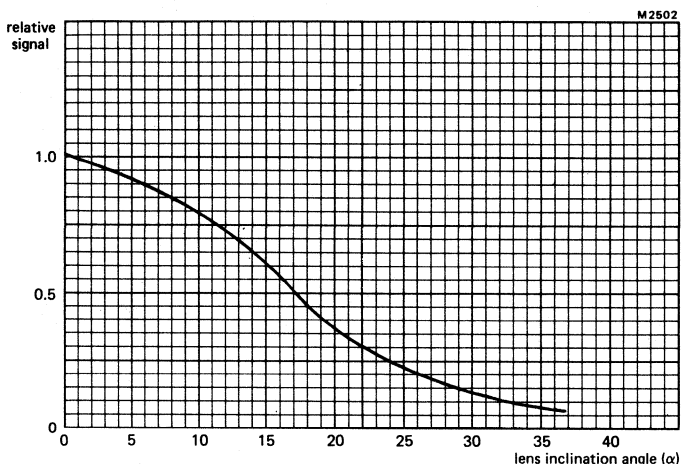

Figure 10 Typical relative signal as a function of lens inclination

Another factor which affects signal level is the sensor angle relative to a zone axis. This arises because sensor sensitivity is approximately dependent on the cosine of the angle between the sensor normal and the direction of incident radiation. In general, directing the sensor axis within approx. 5% of maximum for both 'A' and 'B' zones, where maximum corresponds to radiation at normal incidence (0°). The effective sensitivity of the sensor for the 'C' zone is within approx. 15% of maximum.

If desired, the optimum response may be achieved from one zone row by orientating the sensor vertically towards the effective centre of the central zone element; for the 'A' zones this corresponds approximately to a horizontal position of the sensor axis. Similarly, optimum response along the 'B' or 'C' zones can be achieved by directing the sensor axis at the centre of the appropriate element. Naturally, directing the sensor to favour a particular zone row reduces the signal response for the other rows.

In any particular configuration, account must be taken of any signal reduction factors e.g. lens inclination to a direction axis. Such factors will modify the signal sensitivity versus range curve. Because some of the effects associated with lens/sensor movement can independently affect signal cancellation, e.g. focusing and zonal coverage density, and because of the nature of real sources, the modification of overall response will only be approximated by the summation of all the separate reduction factors.

REFERENCE

1. Geometrical and physical optics, R.S. Longhurst (Longman).

ORDERING

The lens is available **only** in conjunction with one of our range of pyroelectric sensors and is obtainable by adding the suffix FL to our sensor part number.

INDEX OF TYPE NUMBERS

The inclusion of a type number in this publication does not necessarily imply its availability.

type no.	book	section	type no.	book	section	type no.	book	section
BA220	S1	SD	BAS29	S7/S1	Mm/SD	BAV101	S7/S1	Mm/SD
BA221	S1	SD	BAS31	S7/S1	Mm/SD	BAV102	S7/S1	Mm/SD
BA223	S1	T	BAS32	S7/S1	Mm/SD	BAV103	S7/S1	Mm/SD
BA281	S1	SD	BAS35	S7/S1	Mm/SD	BAW56	S7/S1	Mm/SD
BA314	S1	Vrg	BAS45	S1	SD	BAW62	S1	SD
BA315	S1	Vrg	BAS56	S1/S7	SD/Mm	BAX12	S1	SD
BA316	S1	SD	BAT17	S7/S1	Mm/T	BAX14	S1	SD
BA317	S1	SD	BAT18	S7/S1	Mm/T	BAX18	S1	SD
BA318	S1	SD	BAT54	S1/S7	SD/Mm	BAY80	S1	SD
BA423	S1	T	BAT74	S1/S7	SD/Mm	BB112	S1	T
BA480	S1	T	BAT81	S1	T	BB119	S1	T
BA481	S1	T	BAT82	S1	T	BB130	S1	T
BA482	S1	T	BAT83	S1	T	BB204B	S1	T
BA483	S1	T	BAT85	S1	T	BB204G	S1	T
BA484	S1	T	BAT86	S1	T	BB212	S1	T
BA682	S1/S7	T/Mm	BAV10	S1	SD	BB215	S7	Mm
BA683	S1/S7	T/Mm	BAV18	S1	SD	BB219	S7	Mm
BAS11	S1	SD	BAV19	S1	SD	BB405B	S1	T
BAS15	S1	SD	BAV20	S1	SD	BB417	S1	T
BAS16	S7/S1	Mm/SD	BAV21	S1	SD	BB809	S1	T
BAS17	S7/S1	Mm/Vrg	BAV23	S7/S1	Mm/SD	BB909A	S1	T
BAS19	S7/S1	Mm/SD	BAV45	S1	Sp	BB909B	S1	T
BAS20	S7/S1	Mm/SD	BAV70	S7/S1	Mm/SD	BBY31	S7/S1	Mm/T
BAS21	S7/S1	Mm/SD	BAV99	S7/S1	Mm/SD	BBY40	S7/S1	Mm/T
BAS28	S7/S1	Mm/SD	BAV100	S7/S1	Mm/SD	BC107	S3	Sm

Mm = Microminiature semiconductors
for hybrid circuits

SD = Small-signal diodes

Sm = Small-signal transistors

Sp = Special diodes

T = Tuner diodes

Vrg = Voltage regulator diodes

INDEX

type no.	book	section	type no.	book	section	type no.	book	section
BC108	S3	Sm	BC808	S7	Mm	BCX17;R	S7	Mm
BC109	S3	Sm	BC817	S7	Mm	BCX18;R	S7	Mm
BC140	S3	Sm	BC818	S7	Mm	BCX19;R	S7	Mm
BC141	S3	Sm	BC846	S7	Mm	BCX20;R	S7	Mm
BC146	S3	Sm	BC847	S7	Mm	BCX51	S7	Mm
BC160	S3	Sm	BC848	S7	Mm	BCX52	S7	Mm
BC161	S3	Sm	BC849	S7	Mm	BCX53	S7	Mm
BC177	S3	Sm	BC850	S7	Mm	BCX54	S7	Mm
BC178	S3	Sm	BC856	S7	Mm	BCX55	S7	Mm
BC179	S3	Sm	BC857	S7	Mm	BCX56	S7	Mm
BC200	S3	Sm	BC858	S7	Mm	BCX68	S7	Mm
BC264A	S5	FET	BC859	S7	Mm	BCX69	S7	mm
BC264B	S5	FET	BC860	S7	Mm	BCX70*	S7	Mm
BC264C	S5	FET	BC868	S7	Mm	BCX71*	S7	Mm
BC264D	S5	FET	BC869	S7	Mm	BCY56	S3	Sm
BC327;A	S3	Sm	BCF29;R	S7	Mm	BCY57	S3	Sm
BC328	S3	Sm	BCF30;R	S7	Mm	BCY58	S3	Sm
BC337;A	S3	Sm	BCF32;R	S7	Mm	BCY59	S3	Sm
BC338	S3	Sm	BCF33;R	S7	Mm	BCY70	S3	Sm
BC368	S3	Sm	BCF70;R	S7	Mm	BCY71	S3	Sm
BC369	S3	Sm	BCF81;R	S7	Mm	BCY72	S3	Sm
BC375	S3	Sm	BCV26	S7	Mm	BCY78	S3	Sm
BC376	S3	Sm	BCV27	S7	Mm	BCY79	S3	Sm
BC546	S3	Sm	BCV61	S7	Mm	BCY87	S3	Sm
BC547	S3	Sm	BCV62	S7	Mm	BCY88	S3	Sm
BC548	S3	Sm	BCV71;R	S7	Mm	BCY89	S3	Sm
BC549	S3	Sm	BCV72;R	S7	Mm	BD131	S4a	P
BC550	S3	Sm	BCW29;R	S7	Mm	BD132	S4a	P
BC556	S3	Sm	BCW30;R	S7	Mm	BD135	S4a	P
BC557	S3	Sm	BCW31;R	S7	Mm	BD136	S4a	P
BC558	S3	Sm	BCW32;R	S7	Mm	BD137	S4a	P
BC559	S3	Sm	BCW33;R	S7	Mm	BD138	S4a	P
BC560	S3	Sm	BCW60*	S7	Mm	BD139	S4a	P
BC635	S3	Sm	BCW61*	S7	Mm	BD140	S4a	P
BC636	S3	Sm	BCW69;R	S7	Mm	BD201	S4a	P
BC637	S3	Sm	BCW70;R	S7	Mm	BD202	S4a	P
BC638	S3	Sm	BCW71;R	S7	Mm	BD203	S4a	P
BC639	S3	Sm	BCW72;R	S7	Mm	BD204	S4a	P
BC640	S3	Sm	BCW81;R	S7	Mm	BD226	S4a	P
BC807	S7	Mm	BCW89;R	S7	Mm	BD227	S4a	P

* = series
 FET = Field-effect transistors
 Mm = Microminiature semiconductors
 for hybrid circuits

P = Low-frequency power transistors
 Sm = Small-signal transistors

type no.	book	section	type no.	book	section	type no.	book	section
BD228	S4a	P	BD335	S4a	P	BD839	S4a	P
BD229	S4a	P	BD336	S4a	P	BD840	S4a	P
BD230	S4a	P	BD337	S4a	P	BD841	S4a	P
BD231	S4a	P	BD338	S4a	P	BD842	S4a	P
BD233	S4a	P	BD433	S4a	P	BD843	S4a	P
BD234	S4a	P	BD434	S4a	P	BD844	S4a	P
BD235	S4a	P	BD435	S4a	P	BD845	S4a	P
BD236	S4a	P	BD436	S4a	P	BD846	S4a	P
BD237	S4a	P	BD437	S4a	P	BD847	S4a	P
BD238	S4a	P	BD438	S4a	P	BD848	S4a	P
BD239	S4a	P	BD645	S4a	P	BD849	S4a	P
BD239A	S4a	P	BD646	S4a	P	BD850	S4a	P
BD239B	S4a	P	BD647	S4a	P	BD933	S4a	P
BD239C	S4a	P	BD648	S4a	P	BD934	S4a	P
BD240	S4a	P	BD649	S4a	P	BD935	S4a	P
BD240A	S4a	P	BD650	S4a	P	BD936	S4a	P
BD240B	S4a	P	BD651	S4a	P	BD937	S4a	P
BD240C	S4a	P	BD652	S4a	P	BD938	S4a	P
BD241	S4a	P	BD675	S4a	P	BD939	S4a	P
BD241A	S4a	P	BD676	S4a	P	BD940	S4a	P
BD241B	S4a	P	BD677	S4a	P	BD941	S4a	P
BD241C	S4a	P	BD678	S4a	P	BD942	S4a	P
BD242	S4a	P	BD679	S4a	P	BD943	S4a	P
BD242A	S4a	P	BD680	S4a	P	BD944	S4a	P
BD242B	S4a	P	BD681	S4a	P	BD945	S4a	P
BD242C	S4a	P	BD682	S4a	P	BD946	S4a	P
BD243	S4a	P	BD683	S4a	P	BD947	S4a	P
BD243A	S4a	P	BD684	S4a	P	BD948	S4a	P
BD243B	S4a	P	BD813	S4a	P	BD949	S4a	P
BD243C	S4a	P	BD814	S4a	P	BD950	S4a	P
BD244	S4a	P	BD815	S4a	P	BD951	S4a	P
BD244A	S4a	P	BD816	S4a	P	BD952	S4a	P
BD244B	S4a	P	BD817	S4a	P	BD953	S4a	P
BD244C	S4a	P	BD818	S4a	P	BD954	S4a	P
BD329	S4a	P	BD825	S4a	P	BD955	S4a	P
BD330	S4a	P	BD826	S4a	P	BD956	S4a	P
BD331	S4a	P	BD827	S4a	P	BDT20	S4a	P
BD332	S4a	P	BD828	S4a	P	BDT21	S4a	P
BD333	S4a	P	BD829	S4a	P	BDT29	S4a	P
BD334	S4a	P	BD830	S4a	P	BDT29A	S4a	P

P = Low-frequency power transistors

INDEX

type no.	book	section	type no.	book	section	type no.	book	section
BDT29B	S4a	P	BDT62B	S4a	P	BDV67A	S4a	P
BDT29C	S4a	P	BDT62C	S4a	P	BDV67B	S4a	P
BDT30	S4a	P	BDT63	S4a	P	BDV67C	S4a	P
BDT30A	S4a	P	BDT63A	S4a	P	BDV67D	S4a	P
BDT30B	S4a	P	BDT63B	S4a	P	BDV91	S4a	P
BDT30C	S4a	P	BDT63C	S4a	P	BDV92	S4a	P
BDT31	S4a	P	BDT64	S4a	P	BDV93	S4a	P
BDT31A	S4a	P	BDT64A	S4a	P	BDV94	S4a	P
BDT31B	S4a	P	BDT64B	S4a	P	BDV95	S4a	P
BDT31C	S4a	P	BDT64C	S4a	P	BDV96	S4a	P
BDT32	S4a	P	BDT65	S4a	P	BDW55	S4a	P
BDT32A	S4a	P	BDT65A	S4a	P	BDW56	S4a	P
BDT32B	S4a	P	BDT65B	S4a	P	BDW57	S4a	P
BDT32C	S4a	P	BDT65C	S4a	P	BDW58	S4a	P
BDT41	S4a	P	BDT81	S4a	P	BDW59	S4a	P
BDT41A	S4a	P	BDT82	S4a	P	BDW60	S4a	P
BDT41B	S4a	P	BDT83	S4a	P	BDX35	S4a	P
BDT41C	S4a	P	BDT84	S4a	P	BDX36	S4a	P
BDT42	S4a	P	BDT85	S4a	P	BDX37	S4a	P
BDT42A	S4a	P	BDT86	S4a	P	BDX42	S4a	P
BDT42B	S4a	P	BDT87	S4a	P	BDX43	S4a	P
BDT42C	S4a	P	BDT88	S4a	P	BDX44	S4a	P
BDT51	S4a	P	BDT91	S4a	P	BDX45	S4a	P
BDT52	S4a	P	BDT92	S4a	P	BDX46	S4a	P
BDT53	S4a	P	BDT93	S4a	P	BDX47	S4a	P
BDT54	S4a	P	BDT94	S4a	P	BDX62	S4a	P
BDT55	S4a	P	BDT95	S4a	P	BDX62A	S4a	P
BDT56	S4a	P	BDT96	S4a	P	BDX62B	S4a	P
BDT57	S4a	P	BDV64	S4a	P	BDX62C	S4a	P
BDT58	S4a	P	BDV64A	S4a	P	BDX63	S4a	P
BDT60	S4a	P	BDV64B	S4a	P	BDX63A	S4a	P
BDT60A	S4a	P	BDV64C	S4a	P	BDX63B	S4a	P
BDT60B	S4a	P	BDV65	S4a	P	BDX63C	S4a	P
BDT60C	S4a	P	BDV65A	S4a	P	BDX64	S4a	P
BDT61	S4a	P	BDV65B	S4a	P	BDX64A	S4a	P
BDT61A	S4a	P	BDV65C	S4a	P	BDX64B	S4a	P
BDT61B	S4a	P	BDV66A	S4a	P	BDX64C	S4a	P
BDT61C	S4a	P	BDV66B	S4a	P	BDX65	S4a	P
BDT62	S4a	P	BDV66C	S4a	P	BDX65A	S4a	P
BDT62A	S4a	P	BDV66D	S4a	P	BDX65B	S4a	P

P = Low-frequency power transistors

type no.	book	section	type no.	book	section	type no.	book	section
BDX65C	S4a	P	BF256B	S5	FET	BF593	S4b	HVP
BDX66	S4a	P	BF256C	S5	FET	BF620	S7	Mm
BDX66A	S4a	P	BF324	S3	Sm	BF621	S7	Mm
BDX66B	S4a	P	BF370	S3	Sm	BF622	S7	Mm
BDX66C	S4a	P	BF410A	S5	FET	BF623	S7	Mm
BDX67	S4a	P	BF410B	S5	FET	BF660;R	S7	Mm
BDX67A	S4a	P	BF410C	S5	FET	BF689K	S10	WBT
BDX67B	S4a	P	BF410D	S5	FET	BF763	S10	WBT
BDX67C	S4a	P	BF419	S4b	HVP	BF767	S7	Mm
BDX68	S4a	P	BF420	S3	Sm	BF819	S4b	HVP
BDX68A	S4a	P	BF421	S3	Sm	BF820	S7	Mm
BDX68B	S4a	P	BF422	S3	Sm	BF821	S7	Mm
BDX68C	S4a	P	BF423	S3	Sm	BF822	S7	Mm
BDX69	S4a	P	BF450	S3	Sm	BF823	S7	Mm
BDX69A	S4a	P	BF451	S3	Sm	BF824	S7	Mm
BDX69B	S4a	P	BF457	S4b	HVP	BF840	S7	Mm
BDX69C	S4a	P	BF458	S4b	HVP	BF841	S7	Mm
BDX77	S4a	P	BF459	S4b	HVP	BF857	S4b	HVP
BDX78	S4a	P	BF469	S4b	HVP	BF858	S4b	HVP
BDX91	S4a	P	BF470	S4b	HVP	BF859	S4b	HVP
BDX92	S4a	P	BF471	S4b	HVP	BF869	S4b	HVP
BDX93	S4a	P	BF472	S4b	HVP	BF870	S4b	HVP
BDX94	S4a	P	BF483	S3	Sm	BF871	S4b	HVP
BDX95	S4a	P	BF485	S3	Sm	BF872	S4b	HVP
BDX96	S4a	P	BF487	S3	Sm	BF926	S3	Sm
BDY90	S4a	P	BF494	S3	Sm	BF936	S3	Sm
BDY90A	S4a	P	BF495	S3	Sm	BF939	S3	Sm
BDY91	S4a	P	BF496	S3	Sm	BF960	S5	FET
BDY92	S4a	P	BF510	S7/S5	Mm/FET	BF964	S5	FET
BF198	S3	Sm	BF511	S7/S5	Mm/FET	BF966	S5	FET
BF199	S3	Sm	BF512	S7/S5	Mm/FET	BF967	S3	Sm
BF240	S3	Sm	BF513	S7/S5	Mm/FET	BF970	S3	Sm
BF241	S3	Sm	BF536	S7	Mm	BF979	S3	Sm
BF245A	S5	FET	BF550;R	S7	Mm	BF980	S5	FET
BF245B	S5	FET	BF569	S7	Mm	BF981	S5	FET
BF245C	S5	FET	BF579	S7	Mm	BF982	S5	FET
BF247A	S5	FET	BF583	S4b	HVP	BF989	S7/S5	Mm/FET
BF247B	S5	FET	BF585	S4b	HVP	BF990	S7/S5	Mm/FET
BF247C	S5	FET	BF587	S4b	HVP	BF991	S7/S5	Mm/FET
BF256A	S5	FET	BF591	S4b	HVP	BF992	S7/S5	Mm/FET

FET = Field-effect transistors
HVP = High-voltage power transistors
Mm = Microminiature semiconductors
for hybrid circuits

P = Low-frequency power transistors
Sm = Small-signal transistors
WBT = Wideband transistors

INDEX

type no.	book	section	type no.	book	section	type no.	book	section
BF994	S7/S5	Mm/FET	BFQ63	S10	WBT	BFT46	S7/S5	Mm/FET
BF996	S7/S5	Mm/FET	BFQ65	S10	WBT	BFT92;R	S7	Mm
BFG23	S10	WBT	BFQ66	S10	WBT	BFT93;R	S7	Mm
BFG32	S10	WBT	BFQ67	S7	Mm	BFW10	S5	FET
BFG34	S10	WBT	BFQ68	S10	WBT	BFW11	S5	FET
BFG51	S10	WBT	BFQ136	S10	WBT	BFW12	S5	FET
BFG65	S10	WBT	BFR29	S5	FET	BFW13	S5	FET
BFG67	S7	Mm	BFR30	S7/S5	Mm/FET	BFW16A	S10	WBT
BFG90A	S10	WBT	BFR31	S7/S5	Mm/FET	BFW17A	S10	WBT
BFG91A	S10	WBT	BFR49	S10	WBT	BFW30	S10	WBT
BFG96	S10	WBT	BFR53;R	S7	Mm	BFW61	S5	FET
BFP90A	S10	WBT	BFR54	S3	Sm	BFW92	S10	WBT
BFP91A	S10	WBT	BFR64	S10	WBT	BFW92A	S10	WBT
BFP96	S10	WBT	BFR65	S10	WBT	BFW93	S10	WBT
BFQ10	S5	FET	BFR84	S5	FET	BFX29	S3	Sm
BFQ11	S5	FET	BFR90	S10	WBT	BFX30	S3	Sm
BFQ12	S5	FET	BFR90A	S10	WBT	BFX34	S3	Sm
BFQ13	S5	FET	BFR91	S10	WBT	BFX84	S3	Sm
BFQ14	S5	FET	BFR91A	S10	WBT	BFX85	S3	Sm
BFQ15	S5	FET	BFR92;R	S7	Mm	BFX86	S3	Sm
BFQ16	S5	FET	BFR92A;R	S7	Mm	BFX87	S3	Sm
BFQ17	S7	Mm	BFR93;R	S7	Mm	BFX88	S3	Sm
BFQ18A	S7	Mm	BFR93A;R	S7	Mm	BFX89	S10	WBT
BFQ19	S7	Mm	BFR94	S10	WBT	BFY50	S3	Sm
BFQ22S	S10	WBT	BFR95	S10	WBT	BFY51	S3	Sm
BFQ23	S10	WBT	BFR96	S10	WBT	BFY52	S3	Sm
BFQ23C	S10	WBT	BFR96S	S10	WBT	BFY55	S3	Sm
BFQ24	S10	WBT	BFR101A;B	S7/S5	Mm/FET	BFY90	S10	WBT
BFQ32	S10	WBT	BFS17;R	S7	Mm	BG2000	S1	RT
BFQ32C	S10	WBT	BFS18;R	S7	Mm	BG2097	S1	RT
BFQ32S	S10	WBT	BFS19;R	S7	Mm	BGD102	S10	WBM
BFQ33	S10	WBT	BFS20;R	S7	Mm	BGD102E	S10	WBM
BFQ34	S10	WBT	BFS21	S5	FET	BGD104	S10	WBM
BFQ34T	S10	WBT	BFS21A	S5	FET	BGD104E	S10	WBM
BFQ42	S6	RFP	BFS22A	S6	RFP	BGX11*	S2b	ThM
BFQ43	S6	RFP	BFS23A	S6	RFP	BGX12*	S2b	ThM
BFQ51	S10	WBT	BFT24	S10	WBT	BGX13*	S2b	ThM
BFQ51C	S10	WBT	BFT25;R	S7	Mm	BGX14*	S2b	ThM
BFQ52	S10	WBT	BFT44	S3	Sm	BGX15*	S2b	ThM
BFQ53	S10	WBT	BFT45	S3	Sm	BGX17*	S2b	ThM

* = series

FET = Field-effect transistors

Mm = Microminiature semiconductors
for hybrid circuits

RFP = R.F. power transistors and modules

RT = Tripler

Sm = Small-signal transistors

WBM = Wideband hybrid IC modules

WBT = Wideband transistors

type no.	book	section	type no.	book	section	type no.	book	section
BGX25	S2a	ThM	BGY84A	S10	WBM	BLV95	S6	RFP
BGY22	S6	RFP	BGY85	S10	WBM	BLV96	S6	RFP
BGY22A	S6	RFP	BGY85A	S10	WBM	BLV97	S6	RFP
BGY23	S6	RFP	BGY93A	S6	RFP	BLV98	S6	RFP
BGY23A	S6	RFP	BGY93B	S6	RFP	BLV99	S6	RFP
BGY32	S6	RFP	BGY93C	S6	RFP	BLW29	S6	RFP
BGY33	S6	RFP	BLU20/12	S6	RFP	BLW31	S6	RFP
BGY35	S6	RFP	BLU30/12	S6	RFP	BLW32	S6	RFP
BGY36	S6	RFP	BLU45/12	S6	RFP	BLW33	S6	RFP
BGY40A	S6	RFP	BLU50	S6	RFP	BLW34	S6	RFP
BGY40B	S6	RFP	BLU51	S6	RFP	BLW50F	S6	RFP
BGY41A	S6	RFP	BLU52	S6	RFP	BLW60	S6	RFP
BGY41B	S6	RFP	BLU53	S6	RFP	BLW60C	S6	RFP
BGY43	S6	RFP	BLU60/12	S6	RFP	BLW76	S6	RFP
BGY45A	S6	RFP	BLU97	S6	RFP	BLW77	S6	RFP
BGY45B	S6	RFP	BLU98	S6	RFP	BLW78	S6	RFP
BGY46A	S6	RFP	BLU99	S6	RFP	BLW79	S6	RFP
BGY46B	S6	RFP	BLV10	S6	RFP	BLW80	S6	RFP
BGY47	S6	RFP	BLV11	S6	RFP	BLW81	S6	RFP
BGY50	S10	WBM	BLV20	S6	RFP	BLW82	S6	RFP
BGY51	S10	WBM	BLV21	S6	RFP	BLW83	S6	RFP
BGY52	S10	WBM	BLV25	S6	RFP	BLW84	S6	RFP
BGY53	S10	WBM	BLV30	S6	RFP	BLW85	S6	RFP
BGY54	S10	WBM	BLV30/12	S6	RFP	BLW86	S6	RFP
BGY55	S10	WBM	BLV31	S6	RFP	BLW87	S6	RFP
BGY56	S10	WBM	BLV32F	S6	RFP	BLW89	S6	RFP
BGY57	S10	WBM	BLV33	S6	RFP	BLW90	S6	RFP
BGY58	S10	WBM	BLV33F	S6	RFP	BLW91	S6	RFP
BGY58A	S10	WBM	BLV36	S6	RFP	BLW95	S6	RFP
BGY59	S10	WBM	BLV37	S6	RFP	BLW96	S6	RFP
BGY60	S10	WBM	BLV45/12	S6	RFP	BLW97	S6	RFP
BGY61	S10	WBM	BLV57	S6	RFP	BLW98	S6	RFP
BGY65	S10	WBM	BLV59	S6	RFP	BLW99	S6	RFP
BGY67	S10	WBM	BLV75/12	S6	RFP	BLX13	S6	RFP
BGY67A	S10	WBM	BLV80/28	S6	RFP	BLX13C	S6	RFP
BGY70	S10	WBM	BLV90	S6	RFP	BLX14	S6	RFP
BGY71	S10	WBM	BLV91	S6	RFP	BLX15	S6	RFP
BGY74	S10	WBM	BLV92	S6	RFP	BLX39	S6	RFP
BGY75	S10	WBM	BLV93	S6	RFP	BLX65	S6	RFP
BGY84	S10	WBM	BLV94	S6	RFP	BLX65E	S6	RFP

* = series

RFP = R.F. power transistors and modules

ThM = Thyristor modules

WBM = Wideband hybrid IC modules

INDEX

type no.	book	section	type no.	book	section	type no.	book	section
BLX67	S6	RFP	BPX71	S8b	PDT	BSR56	S7/S5	Mm/FET
BLX68	S6	RFP	BPX72	S8b	PDT	BSR57	S7/S5	Mm/FET
BLX69A	S6	RFP	BR100/03	S2b	Th	BSR58	S7/S5	Mm/FET
BLX91A	S6	RFP	BR101	S3	Sm	BSR60	S3	Sm
BLX91CB	S6	RFP	BRY39	S3	Sm	BSR61	S3	Sm
BLX92A	S6	RFP	BRY56	S3	Sm	BSR62	S3	Sm
BLX93A	S6	RFP	BRY61	S7	Mm	BSS38	S3	Sm
BLX94A	S6	RFP	BRY62	S7	Mm	BSS50	S3	Sm
BLX94C	S6	RFP	BS107	S5	FET	BSS51	S3	Sm
BLX95	S6	RFP	BS170	S5	FET	BSS52	S3	Sm
BLX96	S6	RFP	BSD10	S5	FET	BSS60	S3	Sm
BLX97	S6	RFP	BSD12	S5	FET	BSS61	S3	Sm
BLX98	S6	RFP	BSD20	S5/7	FET	BSS62	S3	Sm
BLY85	S6	RFP	BSD22	S5/7	FET	BSS63;R	S7	Mm
BLY87A	S6	RFP	BSD212	S5	FET	BSS64;R	S7	Mm
BLY87C	S6	RFP	BSD213	S5	FET	BSS68	S3	Sm
BLY88A	S6	RFP	BSD214	S5	FET	BSS83	S5/7	FET/Mm
BLY88C	S6	RFP	BSD215	S5	FET	BST15	S7	Mm
BLY89A	S6	RFP	BSR12;R	S7	Mm	BST16	S7	Mm
BLY89C	S6	RFP	BSR13;R	S7	Mm	BST39	S7	Mm
BLY90	S6	RFP	BSR14;R	S7	Mm	BST40	S7	Mm
BLY91A	S6	RFP	BSR15;R	S7	Mm	BST50	S7	Mm
BLY91C	S6	RFP	BSR16;R	S7	Mm	BST51	S7	Mm
BLY92A	S6	RFP	BSR17;R	S7	Mm	BST52	S7	Mm
BLY92C	S6	RFP	BSR17A;R	S7	Mm	BST60	S7	Mm
BLY93A	S6	RFP	BSR18;R	S7	Mm	BST61	S7	Mm
BLY93C	S6	RFP	BSR18A;R	S7	Mm	BST62	S7	Mm
BLY94	S6	RFP	BSR19; A	S7	Mm	BST70A	S5	FET
BLY97	S6	RFP	BSR20; A	S7	Mm	BST72A	S5	FET
BPF24	S8b	PDT	BSR30	S7	Mm	BST74A	S5	FET
BPW22A	S8a/b	PDT	BSR31	S7	Mm	BST76A	S5	FET
BPW50	S8a/b	PDT	BSR32	S7	Mm	BST78	S5	FET
BPW71	S8b	PDT	BSR33	S7	Mm	BST80	S5/S7	FET/Mm
BPX25	S8b	PDT	BSR40	S7	Mm	BST82	S5/S7	FET/Mm
BPX29	S8b	PDT	BSR41	S7	Mm	BST84	S5/S7	FET/Mm
BPX40	S8b	PDT	BSR42	S7	Mm	BST86	S5/S7	FET/Mm
BPX41	S8b	PDT	BSR43	S7	Mm	BST90	S5	FET
BPX42	S8b	PDT	BSR50	S3	Sm	BST97	S5	FET
BPX61	S8b	PDT	BSR51	S3	Sm	BST100	S5	FET
BPX61P	S8b	PDT	BSR52	S3	Sm	BST110	S5	FET

FET = Field-effect transistors

Mm = Microminiature semiconductors
for hybrid circuits

PDT = Photodiodes or transistors

RFP = R.F. power transistors and modules

Sm = Small-signal transistors

Th = Thyristors

type no.	book	section	type no.	book	section	type no.	book	section
BST120	S5/S7	FET/Mm	BTW40*	S2b	Th	BUV82	S4b	SP
BST122	S5/S7	FET/Mm	BTW42*	S2b	Th	BUV83	S4b	SP
BSV15	S3	Sm	BTW43*	S2b	Tri	BUV89	S4b	SP
BSV16	S3	Sm	BTW45*	S2b	Th	BUV90;A	S4b	SP
BSV17	S3	Sm	BTW58*	S2b	Th	BUW11;A	S4b	SP
BSV52;R	S7	Mm	BTW59*	S2b	Th	BUW12;A	S4b	SP
BSV64	S3	Sm	BTW63*	S2b	Th	BUW13;A	S4b	SP
BSV78	S5	FET	BTW92*	S2b	Th	BUW84	S4b	SP
BSV79	S5	FET	BTX18*	S2b	Th	BUW85	S4b	SP
BSV80	S5	FET	BTX94*	S2b	Tri	BUX46;A	S4b	SP
BSV81	S5	FET	BTY79*	S2b	Th	BUX47;A	S4b	SP
BSW66A	S3	Sm	BTY91*	S2b	Th	BUX48;A	S4b	SP
BSW67A	S3	Sm	BU426	S4b	SP	BUX80	S4b	SP
BSW68A	S3	Sm	BU426A	S4b	SP	BUX81	S4b	SP
BSX19	S3	Sm	BU433	S4b	SP	BUX82	S4b	SP
BSX20	S3	Sm	BU505	S4b	SP	BUX83	S4b	SP
BSX45	S3	Sm	BU506	S4b	SP	BUX84	S4b	SP
BSX46	S3	Sm	BU506D	S4b	SP	BUX84F	S4b	SP
BSX47	S3	Sm	BU508A	S4b	SP	BUX85	S4b	SP
BSX59	S3	Sm	BU508D	S4b	SP	BUX85F	S4b	SP
BSX60	S3	Sm	BU705	S4b	SP	BUX86	S4b	SP
BSX61	S3	Sm	BU706	S4b	SP	BUX87	S4b	SP
BSY95A	S3	Sm	BU706D	S4b	SP	BUX88	S4b	SP
BT136*	S2b	Tri	BU806	S4b	SP	BUX90	S4b	SP
BT137*	S2b	Tri	BU807	S4b	SP	BUX98	S4b	SP
BT138*	S2b	Tri	BU804	S4b	SP	BUX98A	S4b	SP
BT139*	S2b	Tri	BU824	S4b	SP	BUX99	S4b	SP
BT149*	S2b	Th	BU826	S4b	SP	BUY89	S4b	SP
BT151*	S2b	Th	BUP22*	S4b	SP	BUZ10	S9	PM
BT152*	S2b	Th	BUP23*	S4b	SP	BUZ10A	S9	PM
BT153	S2b	Th	BUS11;A	S4b	SP	BUZ11	S9	PM
BT155*	S2b	Th	BUS12;A	S4b	SP	BUZ11A	S9	PM
BT157*	S2b	Th	BUS13;A	S4b	SP	BUZ14	S9	PM
BTV24*	S2b	Th	BUS14;A	S4b	SP	BUZ15	S9	PM
BTV34*	S2b	Tri	BUS21*	S4b	SP	BUZ20	S9	PM
BTV58*	S2b	Th	BUS22*	S4b	SP	BUZ21	S9	PM
BTV59*	S2b	Th	BUS23*	S4b	SP	BUZ23	S9	PM
BTV60*	S2b	Th	BUT11;A	S4b	SP	BUZ24	S9	PM
BTW23*	S2b	Th	BUT11A	S4b	SP	BUZ25	S9	PM
BTW38*	S2b	Th	BUT11AF	S4b	SP	BUZ30	S9	PM

* = series

FET = Field-effect transistors
Mm = Microminiature semiconductors
for hybrid circuits
PM = Power MOS transistors

Sm = Small-signal transistors
SP = Low-frequency switching power transistors
Th = Thyristors
Tri = Triacs

INDEX

type no.	book	section	type no.	book	section	type no.	book	section
BUZ31	S9	PM	BUZ84A	S9	PM	BYV22*	S2a	R
BUZ32	S9	PM	BY228	S1	R	BYV23*	S2a	R
BUZ33	S9	PM	BY229*	S2a	R	BYV24*	S2a	R
BUZ34	S9	PM	BY249*	S2a	R	BYV26*	S1	R
BUZ35	S9	PM	BY260*	S2a	R	BYV27*	S1/S2a	R
BUZ36	S9	PM	BY261*	S2a	R	BYV28*	S1/S2a	R
BUZ40	S9	PM	BY329*	S2a	R	BYV29*	S2a	R
BUZ41A	S9	PM	BY359*	S2a	R	BYV30*	S2a	R
BUZ42	S9	PM	BY438	S1	R	BYV32*	S2a	R
BUZ43	S9	PM	BY448	S1	R	BYV33*	S2a	R
BUZ44A	S9	PM	BY458	S1	R	BYV34*	S2a	R
BUZ45	S9	PM	BY505	S1	R	BYV36*	S1	R
BUZ45A	S9	PM	BY509	S1	R	BYV39*	S2a	R
BUZ45B	S9	PM	BY527	S1	R	BYV42*	S2a	R
BUZ45C	S9	PM	BY584	S1	R	BYV43*	S2a	R
BUZ46	S9	PM	BY588	S1	R	BYV72*	S2a	R
BUZ50A	S9	PM	BY609	S1	R	BYV73*	S2a	R
BUZ50B	S9	PM	BY610	S1	R	BYV79*	S2a	R
BUZ53A	S9	PM	BY614	S1	R	BYV92*	S2a	R
BUZ54	S9	PM	BY619	S1	R	BYV95A	S1	R
BUZ54A	S9	PM	BY620	S1	R	BYV95B	S1	R
BUZ60	S9	PM	BY707	S1	R	BYV95C	S1	R
BUZ60B	S9	PM	BY708	S1	R	BYV96D	S1	R
BUZ63	S9	PM	BY709	S1	R	BYV96E	S1	R
BUZ63B	S9	PM	BY710	S1	R	BYW25*	S2a	R
BUZ64	S9	PM	BY711	S1	R	BYW29*	S2a	R
BUZ71	S9	PM	BY712	S1	R	BYW30*	S2a	R
BUZ71A	S9	PM	BY713	S1	R	BYW31*	S2a	R
BUZ72	S9	PM	BY714	S1	R	BYW54	S1	R
BUZ72A	S9	PM	BYD13*	S1	R	BYW55	S1	R
BUZ73A	S9	PM	BYD33*	S1	R	BYW56	S1	R
BUZ74	S9	PM	BYD73*	S1	R	BYW92*	S2a	R
BUZ74A	S9	PM	BYM56*	S1	R	BYW93*	S2a	R
BUZ76	S9	PM	BYQ28*	S2a	R	BYW94*	S2a	R
BUZ76A	S9	PM	BYR29*	S2a	R	BYW95A	S1	R
BUZ80	S9	PM	BYT79*	S2a	R	BYW95B	S1	R
BUZ80A	S9	PM	BYV10	S1	R	BYW95C	S1	R
BUZ83	S9	PM	BYV19*	S2a	R	BYW96D	S1	R
BUZ83A	S9	PM	BYV20*	S2a	R	BYW96E	S1	R
BUZ84	S9	PM	BYV21*	S2a	R	BYX25*	S2a	R

* = series

PM = Power MOS transistors

R = Rectified diodes

type no.	book	section	type no.	book	section	type no.	book	section
BYX30*	S2a	R	BZX93	S1	Vrf	CNY57AU	S8b	PhC
BYX32*	S2a	R	BZX94	S1	Vrf	CNY57U	S8b	PhC
BYX38*	S2a	R	BZY91*	S2a	Vrg	CNY62	S8b	PhC
BYX39*	S2a	R	BZY93*	S2a	Vrg	CNY63	S8b	PhC
BYX42*	S2a	R	BZY95*	S2a	Vrg	CQF24	S8b	Ph
BYX46*	S2a	R	BZY96*	S2a	Vrg	CQL10A	S8b	Ph
BYX50*	S2a	R	CFX13	S11	M	CQL13A	S8b	Ph
BYX52*	S2a	R	CFX21	S11	M	CQL16	S8b	Ph
BYX56*	S2a	R	CFX30	S11	M	CQ551L	S8a	LED
BYX90G	S1	R	CFX31	S11	M	CQ554	S8a	LED
BYX94	S1	R	CFX32	S11	M	CQ582L	S8a	LED
BYX96*	S2a	R	CFX33	S11	M	CQ582AL	S8a	LED
BYX97*	S2a	R	CNG35	S8b	PhC	CQ584L	S8a	LED
BYX98*	S2a	R	CNG36	S8b	PhC	CQ586L	S8a	LED
BYX99*	S2a	R	CNR36	S8b	PhC	CQ593	S8a	LED
BZD23	S1	Vrg	CNX21	S8b	PhC	CQ593E	S8a	LED
BZT03	S1	Vrg	CNX35	S8b	PhC	CQ593L	S8a	LED
BZV10	S1	Vrf	CNX35U	S8b	PhC	CQ595	S8a	LED
BZV11	S1	Vrf	CNX36	S8b	PhC	CQ595E	S8a	LED
BZV12	S1	Vrf	CNX36U	S8b	PhC	CQ595L	S8a	LED
BZV13	S1	Vrf	CNX38	S8b	PhC	CQ597	S8a	LED
BZV14	S1	Vrf	CNX38U	S8b	PhC	CQ597E	S8a	LED
BZV37	S1	Vrf	CNX39	S8b	PhC	CQ597L	S8a	LED
BZV46	S1	Vrg	CNX39U	S8b	PhC	CQT10B	S8a	LED
BZV49*	S1/S7	Vrg/Mm	CNX44	S8b	PhC	CQT24	S8a	LED
BZV55*	S7	Mm	CNX44A	S8b	PhC	CQT60	S8a	LED
BZV85*	S1	Vrg	CNX46	S8b	PhC	CQT70	S8a	LED
BZW03*	S1	Vrg	CNX48	S8b	PhC	CQT80L	S8a	LED
BZW14	S1	Vrg	CNX48U	S8b	PhC	CQV70(L)	S8a	LED
BZW70*	S2a	TS	CNX62	S8b	PhC	CQV70A(L)	S8a	LED
BZW86*	S2a	TS	CNX72	S8b	PhC	CQV70U(L)	S8a	LED
BZW91*	S2a	TS	CNX82	S8b	PhC	CQV71A(L)	S8a	LED
BZX55*	S1	Vrg	CNX91	S8b	PhC	CQV72(L)	S8a	LED
BZX70*	S2a	Vrg	CNX92	S8b	PhC	CQV80L	S8a	LED
BZX75*	S1	Vrg	CNY17-1	S8b	PhC	CQV80AL	S8a	LED
BZX79*	S1	Vrg	CNY17-2	S8b	PhC	CQV80UL	S8a	LED
BZX84*	S7/S1	Mm/Vrg	CNY17-3	S8b	PhC	CQV81L	S8a	LED
BZX90	S1	Vrf	CNY50	S8b	PhC	CQV82L	S8a	LED
BZX91	S1	Vrf	CNY57	S8b	PhC	CQW10A(L)	S8a	LED
BZX92	S1	Vrf	CNY57A	S8b	PhC	CQW10B(L)	S8a	LED

* = series

LED = Light-emitting diodes

M = Microwave transistors

Mm = Microminiature semiconductors
for hybrid circuits

Ph = Photoconductive devices

PhC = Photocouplers

R = Rectifier diodes

TS = Transient suppressor diodes

Vrf = Voltage reference diodes

Vrg = Voltage regulator diodes

INDEX

type no.	book	section	type no.	book	section	type no.	book	section
CQW10U(L)	S8a	LED	Fresnel-	S8b	A	LKE2004T	S11	M
CQW11B(L)	S8a	LED	lens			LKE2015T	S11	M
CQW12B(L)	S8a	LED	H11A1	S8b	PhC	LKE21004R	S11	M
CQW20A	S8a	LED	H11A2	S8b	PhC	LKE21015T	S11	M
CQW21	S8a	LED	H11A3	S8b	PhC	LKE21050T	S11	M
CQW22	S8a	LED	H11A4	S8b	PhC	LKE27010R	S11	M
CQW24(L)	S8a	LED	H11A5	S8b	PhC	LKE27025R	S11	M
CQW54	S8a	LED	H11B1	S8b	PhC	LKE32002T	S11	M
CQW60(L)	S8a	LED	H11B2	S8b	PhC	LKE32004T	S11	M
CQW60A(L)	S8a	LED	H11B3	S8b	PhC	LTE42005S	S11	M
CQW60U(L)	S8a	LED	H11B255	S8b	PhC	LTE42008R	S11	M
CQW61(L)	S8a	LED	KMZ10A	S13	SEN	LTE42012R	S11	M
CQW62(L)	S8a	LED	KMZ10B	S13	SEN	LV1721E50R	S11	M
CQW89A	S8a/b	I	KMZ10C	S13	SEN	LV2024E45R	S11	M
CQW93	S8a	LED	KP100A	S13	SEN	LV2327E40R	S11	M
CQW95	S8a	LED	KP101A	S13	SEN	LV3742E16R	S11	M
CQW97	S8a	LED	KPZ20G	S13	SEN	LV3742E24R	S11	M
CQX24(L)	S8a	LED	KPZ21G	S13	SEN	LWE2015R	S11	M
CQX51(L)	S8a	LED	KTY81*	S13	SEN	LWE2025R	S11	M
CQX54(L)	S8a	LED	KTY83*	S13	SEN	LZ1418E100RS11	M	
CQX54D	S8a	LED	KTY84*	S13	SEN	MCA230	S8b	PhC
CQX64(L)	S8a	LED	LAE2001R	S11	M	MCA231	S8b	PhC
CQX64D	S8a	LED	LAE4001Q	S11	M	MCA255	S8b	PhC
CQX74(L)	S8a	LED	LAE4001R	S11	M	MCT2	S8b	PhC
CQX74D	S8a	LED	LAE4002S	S11	M	MCT26	S8b	PhC
CQY11B	S8b	LED	LAE6000Q	S11	M	MKB12040WS	S11	M
CQY11C	S8b	LED	LBE1004R	S11	M	MKB12100WS	S11	M
CQY24B(L)	S8a	LED	LBE1010R	S11	M	MKB12140W	S11	M
CQY49B	S8b	LED	LBE2003S	S11	M	M06075B200ZS11	M	
CQY49C	S8b	LED	LBE2005Q	S11	M	M06075B400ZS11	M	
CQY50	S8b	LED	LBE2008T	S11	M	MRB12175YR	S11	M
CQY52	S8b	LED	LBE2009S	S11	M	MRB12350YR	S11	M
CQY53S	S8b	LED	LCE1010R	S11	M	MS1011B700YS11	M	
CQY54A	S8a	LED	LCE2003S	S11	M	MS6075B800ZS11	M	
CQY58A	S8a/b	I	LCE2005Q	S11	M	MSB12900Y	S11	M
CQY89A	S8a/b	I	LCE2008T	S11	M	MZ0912B75Y	S11	M
CQY94B(L)	S8a	LED	LCE2009S	S11	M	MZ0912B150YS11	M	
CQY95B	S8a	LED	LJE42002T	S11	M	OM286; M	S13	SEN
CQY96(L)	S8a	LED	LKE1004R	S11	M	OM287; M	S13	SEN
CQY97A	S8a	LED	LKE2002T	S11	M	OM320	S10	WBM

* = series

A = Accessories

I = Infrared devices

LED = Light-emitting diodes

M = Microwave transistors

PhC = Photocouplers

SEN = Sensors

WBM = Wideband hybrid IC modules

type no.	book	section	type no.	book	section	type no.	book	section
OM321	S10	WBM	OSS9215	S2a	St	PMBF4392	S7	Mm
OM322	S10	WBM	OSS9410	S2a	St	PMBF4392	S7	Mm
OM323	S10	WBM	OSS9415	S2a	St	PO44	S8b	PhC
OM323A	S10	WBM	P2105	S8b	I	P044A	S8b	PhC
OM335	S10	WBM	PBMF4391	S5	FET	PPC5001T	S11	M
OM336	S10	WBM	PBMF4392	S5	FET	PQC5001T	S11	M
OM337	S10	WBM	PBMF4393	S5	FET	PTB23001X	S11	M
OM337A	S10	WBM	PDE1001U	S11	M	PTB23003X	S11	M
OM339	S10	WBM	PDE1003U	S11	M	PTB23005X	S11	M
OM345	S10	WBM	PDE1005U	S11	M	PTB32001X	S11	M
OM350	S10	WBM	PDE1010U	S11	M	PTB32003X	S11	M
OM360	S10	WBM	PEE1001U	S11	M	PTB32005X	S11	M
OM361	S10	WBM	PEE1003U	S11	M	PTB42001X	S11	M
OM370	S10	WBM	PEE1005U	S11	M	PTB42002X	S11	M
OM386B	S13	SEN	PEE1010U	S11	M	PTB42003X	S11	M
OM386M	S13	SEN	PH2222;R	S3	Sm	PV3742B4X	S11	M
OM387B	S13	SEN	PH2222A;R	S3	Sm	PVB42004X	S11	M
OM387M	S13	SEN	PH2369	S3	Sm	PZ1418B15U	S11	M
OM388B	S13	SEN	PH2907;R	S3	Sm	PZ1418B30U	S11	M
OM389B	S13	SEN	PH2907A;R	S3	Sm	PZ1721B12U	S11	M
OM931	S4a	P	PH2955T	S4a	P	PZ1721B25U	S11	M
OM961	S4a	P	PH3055T	S4a	P	PZ2024B10U	S11	M
OSB9110	S2a	St	PH5415	S3	Sm	PZ2024B20U	S11	M
OSB9115	S2a	St	PH5416	S3	Sm	PZB16035U	S11	M
OSB9210	S2a	St	PH13002	S4b	SP	PZB27020U	S11	M
OSB9215	S2a	St	PH13003	S4b	SP	RPY97	S8b	I
OSB9410	S2a	St	PHSD51	S2a	R	RPY100	S8b	I
OSB9415	S2a	St	PKB3001U	S11	M	RPY101	S8b	I
OSM9110	S2a	St	PKB3003U	S11	M	RPY102	S8b	I
OSM9115	S2a	St	PKB3005U	S11	M	RPY103	S8b	I
OSM9210	S2a	St	PKB12005U	S11	M	RPY107	S8b	I
OSM9215	S2a	St	PKB20010U	S11	M	RPY109	S8b	I
OSM9410	S2a	St	PKB23001U	S11	M	RV3135B5X	S11	M
OSM9415	S2a	St	PKB23003U	S11	M	RX1214B300YS11	M	
OSM9510	S2a	St	PKB23005U	S11	M	RXB12350Y	S11	M
OSM9511	S2a	St	PKB25006T	S11	M	RZ1214B35Y	S11	M
OSM9512	S2a	St	PKB32001U	S11	M	RZ1214B60W	S11	M
OSS9110	S2a	St	PKB32003U	S11	M	RZ1214B65Y	S11	M
OSS9115	S2a	St	PKB32005U	S11	M	RZ1214B125WS11	M	
OSS9210	S2a	St	PMBF4391	S7	Mm	RZ1214B125YS11	M	

FET = Field-effect transistors

I = Infrared devices

M = Microwave transistors

Mm = Microminiature semiconductors
for hybrid circuits

P = Low-frequency power transistors

PhC = Photocouplers

R = Rectifier diodes

SEN = Sensors

Sm = Small-signal transistors

SP = Low-frequency switching power transistors

St = Rectifier stacks

WBM = Wideband hybrid IC modules

INDEX

type no.	book	section	type no.	book	section	type no.	book	section
RZ1214B150YS11	M		TIP130	S4a	P	1N4006G	S1	R
RZ2833B45W	S11	M	TIP131	S4a	P	1N4007G	S1	R
RZ3135B15U	S11	M	TIP132	S4a	P	1N4148	S1	SD
RZ3135B15W	S11	M	TIP135	S4a	P	1N4150	S1	SD
RZ3135B25U	S11	M	TIP136	S4a	P	1N4151	S1	SD
RZ3135B30W	S11	M	TIP137	S4a	P	1N4153	S1	SD
RZB12100Y	S11	M	TIP140	S4a	P	1N4446	S1	SD
RZB12350Y	S11	M	TIP141	S4a	P	1N4448	S1	SD
RZZ1214B30OYS11	M		TIP145	S4a	P	1N4531	S1	SD
SL5500	S8b	PhC	TIP146	S4a	P	1N4532	S1	SD
SL5501	S8b	PhC	TIP147	S4a	P	1N5059	S1	R
SL5502R	S8b	PhC	TIP2955	S4a	P	1N5060	S1	R
SL5504	S8b	PhC	TIP3055	S4a	P	1N5061	S1	R
SL5504S	S8b	PhC	1N821;A	S1	Vrf	1N5062	S1	R
SL5505S	S8b	PhC	1N823;A	S1	Vrf	1N5832	S2a	R
SL5511	S8b	PhC	1N825;A	S1	Vrf	1N5833	S2a	R
TIP29*	S4a	P	1N827;A	S1	Vrf	1N5834	S2a	R
TIP30*	S4a	P	1N829;A	S1	Vrf	1N6097	S2a	R
TIP31*	S4a	P	1N914	S1	SD	1N6098	S2a	R
TIP32*	S4a	P	1N916	S1	SD	2N918	S10	WBT
TIP33*	S4a	P	1N3879	S2a	R	2N929	S3	Sm
TIP34*	S4a	P	1N3880	S2a	R	2N930	S3	Sm
TIP41*	S4a	P	1N3881	S2a	R	2N1613	S3	Sm
TIP42*	S4a	P	1N3882	S2a	R	2N1711	S3	Sm
TIP47	S4a	P	1N3883	S2a	R	2N1893	S3	Sm
TIP48	S4a	P	1N3889	S2a	R	2N2219	S3	Sm
TIP49	S4a	P	1N3890	S2a	R	2N2219A	S3	Sm
TIP50	S4a	P	1N3891	S2a	R	2N2222	S3	Sm
TIP110	S4a	P	1N3892	S2a	R	2N2222A	S3	Sm
TIP111	S4a	P	1N3893	S2a	R	2N2297	S3	Sm
TIP112	S4a	P	1N3909	S2a	R	2N2368	S3	Sm
TIP115	S4a	P	1N3910	S2a	R	2N2369	S3	Sm
TIP116	S4a	P	1N3911	S2a	R	2N2369A	S3	Sm
TIP117	S4a	P	1N3912	S2a	R	2N2483	S3	Sm
TIP120	S4a	P	1N3913	S2a	R	2N2484	S3	Sm
TIP121	S4a	P	1N4001G	S1	R	2N2904	S3	Sm
TIP122	S4a	P	1N4002G	S1	R	2N2904A	S3	Sm
TIP125	S4a	P	1N4003G	S1	R	2N2905	S3	Sm
TIP126	S4a	P	1N4004G	S1	R	2N2905A	S3	Sm
TIP127	S4a	P	1N4005G	S1	R	2N2906	S3	Sm

* = series

M = Microwave transistors

P = Low-frequency power transistors

PhC = Photocouplers

R = Rectifier diodes

SD = Small-signal diodes

Sm = Small-signal transistors

Vrf = Voltage reference diodes

WBT = Wideband transistors

type no.	book	section	type no.	book	section	type no.	book	section
2N2906A	S3	Sm	2N4126	S3	Sm	502CQF	S8b	Ph
2N2907	S3	Sm	2N4391	S5	FET	503CQF	S8b	Ph
2N2907A	S3	Sm	2N4392	S5	FET	504CQL	S8b	Ph
2N3019	S3	Sm	2N4393	S5	FET	516CQF-B	S8b	Ph
2N3020	S3	Sm	2N4427	S6	RFP	56201d	S4b	A
2N3053	S3	Sm	2N4856	S5	FET	56201j	S4b	A
2N3375	S6	RFP	2N4857	S5	FET	56245	S3, 10	A
2N3553	S6	RFP	2N4858	S5	FET	56246	S3, 10	A
2N3632	S6	RFP	2N4859	S5	FET	56261a	S4b	A
2N3822	S5	FET	2N4860	S5	FET	56264a, b	S2a/b	A
2N3823	S5	FET	2N4861	S5	FET	56295	S2a/b	A
2N3866	S6	RFP	2N5400	S3	Sm	56326	S4b	A
2N3903	S3	Sm	2N5401	S3	Sm	56339	S4b	A
2N3904	S3	Sm	2N5415	S3	Sm	56352	S4b	A
2N3905	S3	Sm	2N5416	S3	Sm	56353	S4b	A
2N3906	S3	Sm	2N5550	S3	Sm	56354	S4b	A
2N3924	S6	RFP	2N5551	S3	Sm	56359b	S2, 4b	A
2N3926	S6	RFP	2N6659	S5	FET	56359c	S2, 4b	A
2N3927	S6	RFP	2N6660	S5	FET	56359d	S2, 4b	A
2N3966	S5	FET	2N6661	S5	FET	56360a	S2, 4b	A
2N4030	S3	Sm	4N25	S8b	PhC	56363	S2, 4b	A
2N4031	S3	Sm	4N25A	S8b	PhC	56364	S2, 4b	A
2N4032	S3	Sm	4N26	S8b	PhC	56367	S2a/b	A
2N4033	S3	Sm	4N27	S8b	PhC	56368a	S2, 4b	A
2N4091	S5	FET	4N28	S8b	PhC	56368b	S2, 4b	A
2N4092	S5	FET	4N35	S8b	PhC	56369	S2, 4b	A
2N4093	S5	FET	4N36	S8b	PhC	56378	S2, 4b	A
2N4123	S3	Sm	4N37	S8b	PhC	56379	S2, 4b	A
2N4124	S3	Sm	4N38	S8b	PhC	56387a, b	S4b	A
2N4125	S3	Sm	4N38A	S8b	PhC			

- A = Accessories
- FET = Field-effect transistors
- Ph = Photoconductive devices
- PhC = Photocouplers
- RFP = R.F. power transistors and modules
- Sm = Small-signal transistors

NOTES

Electronic components and materials for professional, industrial and consumer uses from the world-wide Philips Group of Companies

- Argentina:** PHILIPS ARGENTINA S.A., Div. Elcoma, Vedia 3892, 1430 BUENOS AIRES, Tel. 541-7141/7242/7343/7444/7545.
- Australia:** PHILIPS INDUSTRIES HOLDINGS LTD., Elcoma Division, 11 Waltham Street, ARTARMON, N.S.W. 2064, Tel. (02) 439 3322.
- Austria:** ÖSTERREICHISCHE PHILIPS BAUELEMENTE INDUSTRIE G.m.b.H., Triester Str. 64, A-1101 WIEN, Tel. 62 91 11-0.
- Belgium:** N.V. PHILIPS & MBLE ASSOCIATED, 9 rue du Pavillon, B-1030 BRUXELLES, Tel. (02) 242 7400.
- Brazil:** IBRAPE, Caixa Postal 7383, Av. Brigadeiro Faria Lima, 1735 SAO PAULO, SP, Tel. (011) 211-2600.
- Canada:** PHILIPS ELECTRONICS LTD., Elcoma Division, 601 Milner Ave., SCARBOROUGH, Ontario, M1B 1M8, Tel. 292-5161.
- Chile:** PHILIPS CHILENA S.A., Av. Santa Maria 0760, SANTIAGO, Tel. 39-4001.
- Colombia:** IND. PHILIPS DE COLOMBIA S.A., c/o IPRELENSO LTD., Cra. 21, No. 56-17, BOGOTA, D.E., Tel. 249 7624.
- Denmark:** MINIWATT A/S, Strandlodsvej 2, P.O. Box 1919, DK 2300 COPENHAGEN S, Tel. (01) 54 11 33.
- Finland:** OY PHILIPS AB, Elcoma Division, Kaivokatu 8, SF-00100 HELSINKI 10, Tel. 1 72 71.
- France:** RTC-COMPELEC, 130 Avenue Ledru Rollin, F-75540 PARIS 11, Tel. 43 38 80 00.
- Germany (Fed. Republic):** VALVO, UB Bauelemente der Philips G.m.b.H., Valvo Haus, Burchardstrasse 19, D-2 HAMBURG 1, Tel. (040) 3296-0.
- Greece:** PHILIPS HELLENIQUE S.A., Elcoma Division, 54, Syngrou Av., ATHENS 11742, Tel. 9215311/319.
- Hong Kong:** PHILIPS HONG KONG LTD., Elcoma Div., 15/F Philips Ind. Bldg., 24-28 Kung Yip St., KWAI CHUNG, Tel. (0)-2451 21.
- India:** PEICO ELECTRONICS & ELECTRICALS LTD., Elcoma Dept., Band Box Building, 254-D Dr. Annie Besant Rd., BOMBAY - 400 025, Tel. 4930311/4930590.
- Indonesia:** P.T. PHILIPS-RALIN ELECTRONICS, Elcoma Div., Setiabudi II Building, 6th Fl., Jalan H.R. Rasuna Said (P.O. Box 223/KBY) Kuningan, JAKARTA - Selatan, Tel. 512 572.
- Ireland:** PHILIPS ELECTRICAL (IRELAND) LTD., Newstead, Clonskeagh, DUBLIN 14, Tel. 693355.
- Italy:** PHILIPS S.p.A., Sezione Elcoma, Piazza IV Novembre 3, I-20124 MILANO, Tel. 2-6752 1.
- Japan:** NIHON PHILIPS CORP., Shuwa Shinagawa Bldg., 26-33 Takanawa 3-chome, Minato-ku, TOKYO (108), Tel. 448-5611.
(IC Products) SIGNETICS JAPAN LTD., 8-7 Sanbancho Chiyoda-ku, TOKYO 102, Tel. (03) 230-1521.
- Korea (Republic of):** PHILIPS ELECTRONICS (KOREA) LTD., Elcoma Div., Philips House, 260-199 Itaewon-dong, Yongsan-ku, SEOUL, Tel. 794-5011.
- Malaysia:** PHILIPS MALAYSIA SDN. BERHAD, No. 4 Persiaran Barat, Petaling Jaya, P.O.B. 2163, KUALA LUMPUR, Selangor, Tel. 77 44 11.
- Mexico:** ELECTRONICA, S.A. de C.V., Carr. México-Toluca km. 62.5, TOLUCA, Edo. de México 50140, Tel. Toluca 91 (721) 613-00.
- Netherlands:** PHILIPS NEDERLAND, Marktgroep Elconco, Postbus 90050, 5600 PB EINDHOVEN, Tel. (040) 793333.
- New Zealand:** PHILIPS NEW ZEALAND LTD., Elcoma Division, 110 Mt. Eden Road, C.P.O. Box 1041, AUCKLAND, Tel. 605-914.
- Norway:** NORSK A/S PHILIPS, Electronica Dept., Sandstuveien 70, OSLO 6, Tel. 68 02 00.
- Peru:** CADESA, Av. Alfonso Ugarte 1268, LIMA 5, Tel. 326070.
- Philippines:** PHILIPS INDUSTRIAL DEV. INC., 2246 Pasong Tamo, P.O. Box 911, Makati Comm. Centre, MAKATI-RIZAL 3116, Tel. 86-89-51 to 59.
- Portugal:** PHILIPS PORTUGUESA S.A.R.L., Av. Eng. Duarte Pacheco 6, 1009 LISBOA Codex, Tel. 68 31 21.
- Singapore:** PHILIPS PROJECT DEV. (Singapore) PTE LTD., Elcoma Div., Lorong 1, Toa Payoh, SINGAPORE 1231, Tel. 3502 000.
- South Africa:** EDAC (PTY.) LTD., 3rd Floor Rainer House, Upper Railway Rd. & Ove St., New Doornfontein, JOHANNESBURG 2001, Tel. 614-2362/9.
- Spain:** MINIWATT S.A., Balmes 22, BARCELONA 7, Tel. 301 63 12.
- Sweden:** PHILIPS KOMPONENTER A.B., Lidingövägen 50, S-11584 STOCKHOLM 27, Tel. 08 7821000.
- Switzerland:** PHILIPS A.G., Elcoma Dept., Allmendstrasse 140-142, CH-8027 ZÜRICH, Tel. 01-48822 11.
- Taiwan:** PHILIPS TAIWAN LTD., 150 Tun Hua North Road, P.O. Box 22978, TAIPEI, Taiwan, Tel. 7120500.
- Thailand:** PHILIPS ELECTRICAL CO. OF THAILAND LTD., 283 Silom Road, P.O. Box 961, BANGKOK, Tel. 233-6330-9.
- Turkey:** TÜRK PHILIPS TICARET A.S., Elcoma Department, İnönü Cad, No. 78-80, P.K.504, 80074 ISTANBUL, Tel. 43 59 10.
- United Kingdom:** MULLARD LTD., Mullard House, Torrington Place, LONDON WC1E 7HD, Tel. 01-5806633.
- United States:** (Active Devices & Materials) AMPEREX SALES CORP., Providence Pike, SLATERSVILLE, R.I. 02876, Tel. (401) 762-9000.
(Passive Devices) MEPCO/ELECTRA INC., Columbia Rd., MORRISTOWN, N.J. 07960, Tel. (201) 539-2000.
(Passive Devices & Electromechanical Devices) CENTRALAB INC., 5855 N. Glen Park Rd., MILWAUKEE, WI 53201, Tel. (414)228-7380.
(IC Products) SIGNETICS CORPORATION, 811 East Arques Avenue, SUNNYVALE, California 94086, Tel. (408) 991-2000.
- Uruguay:** LUZILECTRON S.A., Avda Uruguay 1287, P.O. Box 907, MONTEVIDEO, Tel. 91 43 21.
- Venezuela:** IND. VENEZOLANAS PHILIPS S.A., c/o MAGNETICA S.A., Calle 6, Ed. Las Tres Jotas, App. Post. 78117, CARACAS, Tel. (02) 2393931.

For all other countries apply to: Philips Electronic Components and Materials Division, International Business Relations, P.O. Box 218, 5600 MD EINDHOVEN, The Netherlands, Telex 35000 phtnl

AS52

© Philips Export B.V. 1986

This information is furnished for guidance, and with no guarantee as to its accuracy or completeness; its publication conveys no licence under any patent or other right, nor does the publisher assume liability for any consequence of its use; specifications and availability of goods mentioned in it are subject to change without notice; it is not to be reproduced in any way, in whole or in part, without the written consent of the publisher.